

LIVING

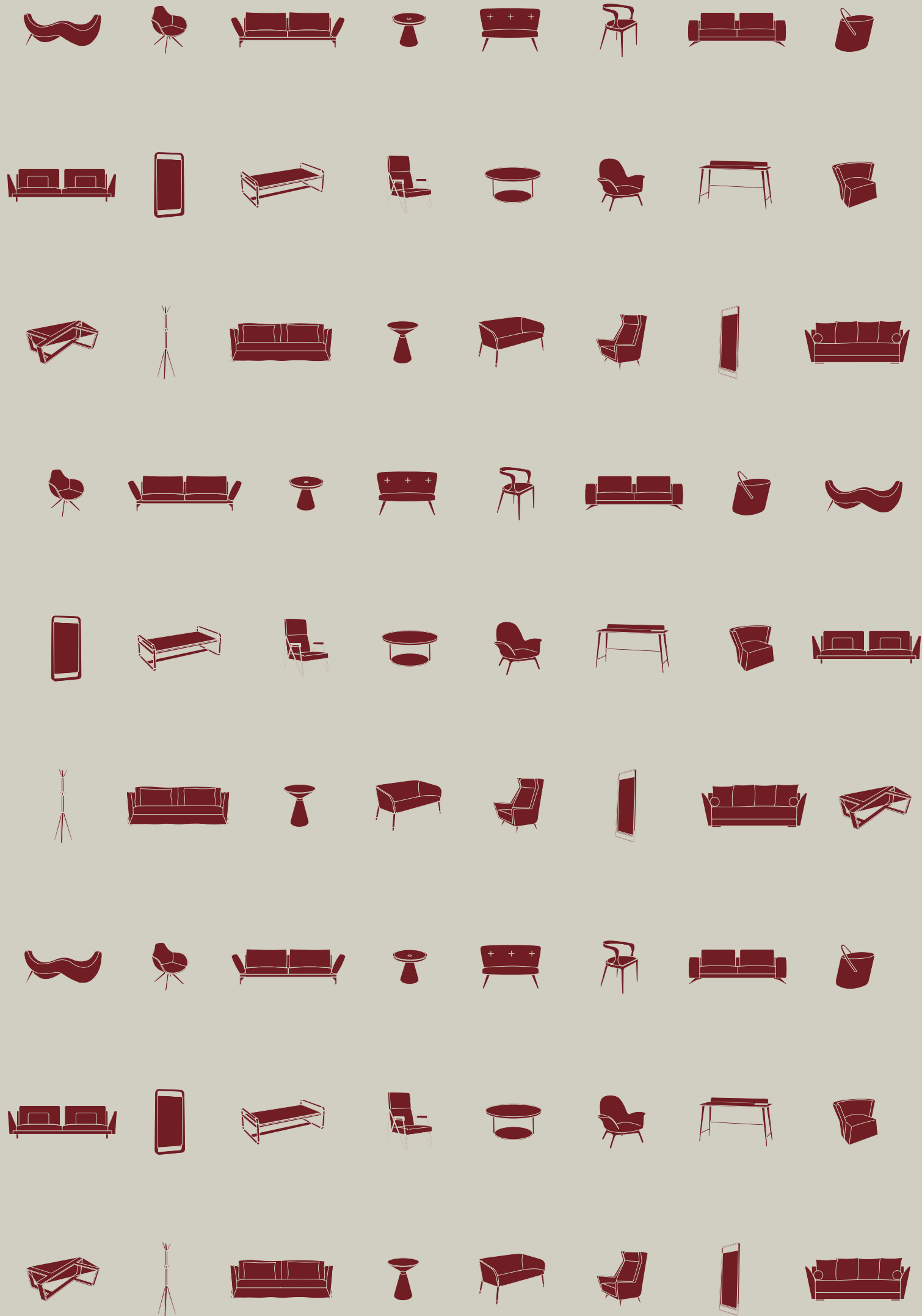

BeltáFraJumar

FURNITURE AND UPHOLSTERY MANUFACTURER SINCE 1967



**BeltáFraJumar**  
THE HOME COLLECTION

Descarga aquí la última versión del catálogo, 

*Download here the latest version of the catalogue.* 

Téléchargez ici la dernière version du catalogue 

Style  
Culture  
Since  
1967

beltá  
FRANMAR®



# Index

Sofás | Sofas | Canapés

**ALAN**



10-13

**AXIS**



14-17

**BASIK**



18-19

**NIMO**



72-75

**OLIV**



76-79

**SLIM**



80-83

**COOL**



20-23

**COSY**



24-25

**EDAI**



26-29

**SUIT**



84-87

**WELL**



88-91

**WING**



92-95

**EGOS**



30-33

**EMUC**



34-37

**ERIK**



38-41

**GUES**



42-45

**ILUM**



46-49

**INSIDE**



50-51

## Sofás Cama | Sofa Beds | Canapés Lit

**DARO OP.A**



98-99

**DARO OP.B**



98-99

**DARO OP.D**



98-99

**INUA**



52-55

**KOTA**



56-57

**LOBI**



58-59

**DUE**



100-103

**SPAT**



104-107

**TRUE**



108-109

**LOFT**



60-63

**MUSA**



64-67

**MUST**



68-71

# Index

Sofás Relax | *Relax Sofas* | Canapés Relax



**KLAS**

114-117



**TEGA**

110-113

Butacas | *Armchairs* | Fauteuils



**ADEX**

118



**ARBO**

119



**ALMA**

120



**APIL**

121



**ARKO**

122



**BAZK**

124-125



**BLOM**

126-127



**BOSS**

123



**DELP**

128



**DELTA**

130-131



**DIAB**

132



**ECKO**

133



**EGON**

134



**ERIK**

135



**ERNE**

136-137



**ERTO**

129



**EVEN**

138-139



**GOIA**

140



**KIDA**

141



**KORA**

142-143



**LASE**

144



**MARC**

145



**MUSE**

148



**NIES**

146-147



**OFRE**

149



**ONLY**

150



**PAO**

152-153



**PUNK**

154



**TAMO**

156-157



**TERY**

155



**THIN**

158-159



**VERA**

151

# Index

Mesas | *Tables* | Tables

AGOL



162

ALO



163

BACK



164

DOMO



166-167

EVEN



165

FRES



168

GIB



169

HERA



171

ICON



170

IGNO



173

ISEN



172

LAYA



174

LUNA



173

LUXU



174

OLIA



175

OPEN



176

PENT



192-193

RUND



177

Complementos | *Complements* | Accessoires

BESK



194-195

CUBE



190-191

GORK



182-183

HANG



180-181

HANG



180-181

MARS



188

OPOF



184

PENT



192-193

POET



196-197

SEDAN



185

SKON XL



186-187

SKON L



186-187

SKON XS



186-187

SPIN



198-199

TEO



189

La experiencia  
y la trayectoria nos  
enseña que es  
necesario analizar  
todo lo sucedido  
para actuar en el  
presente y para saber  
adelantar el futuro.

*Our experience and our history teach us  
that it is necessary to analyse everything  
that has happened in order to act in the pre-  
sent and to know how to interpret the future.*

*L'expérience et la trajectoire nous  
apprennent qu'il est nécessaire d'analy-  
ser tout ce qui s'est passé pour agir dans  
le présent et savoir interpréter l'avenir.*



Carmen Ortiz and Francisco Juan, founders of Beltá Frajumar in 1967.

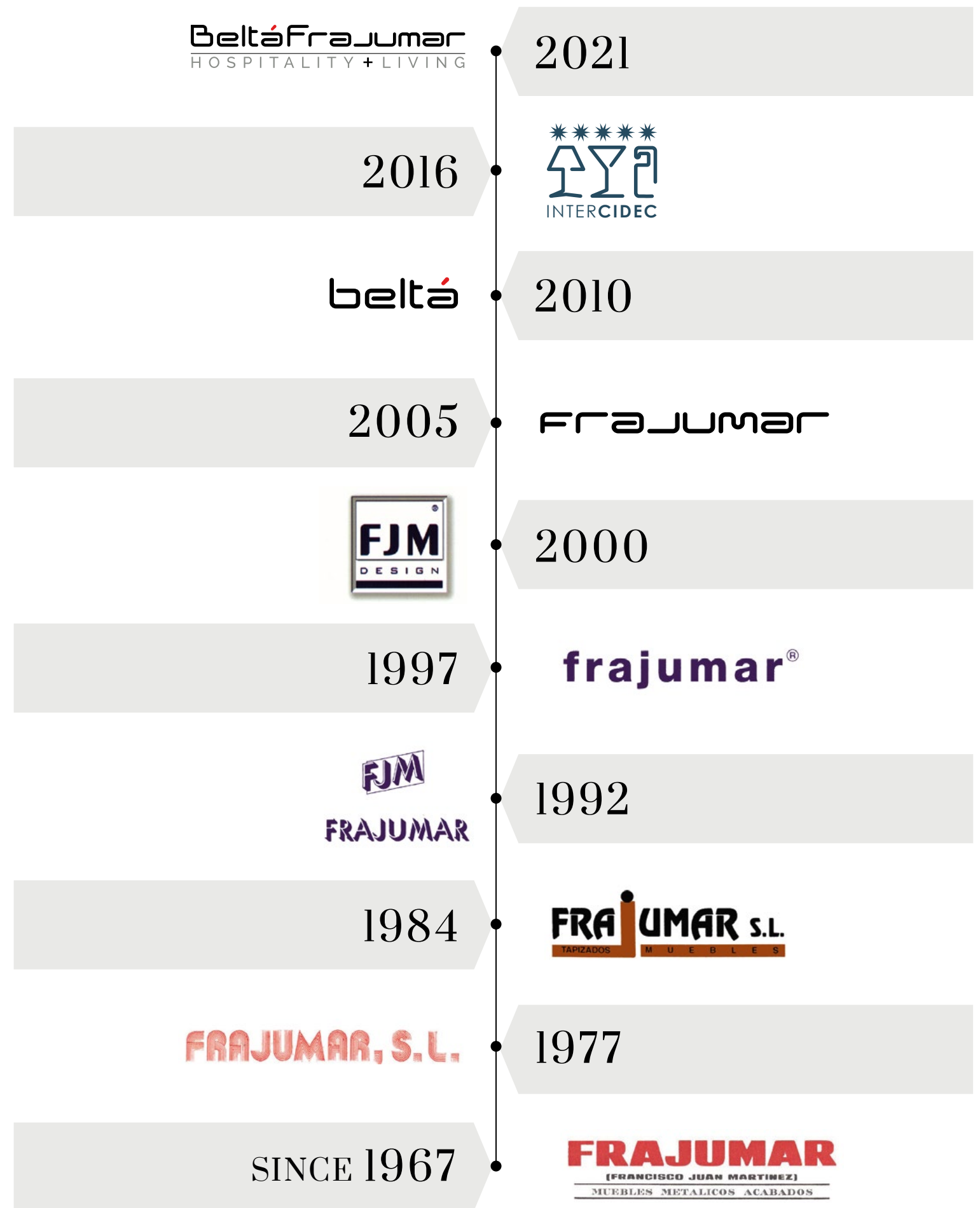



.ALAN sofa, OP.1 arm with cushion, oak finish legs. Dimensions CM 232x98 H90.

.APIL armchair, oak finish legs. Dimensions CM 73x79 H75.

.OPEN side table, walnut finished. Dimensions CM Ø60 H43.



# Alan

D. E. Gagliardini

Alan es atemporal y al mismo tiempo ligado a las tendencias de diseño más actuales. Su fuerza radica en el confort, de ahí el gran número de cojines, los cuales permiten jugar con la profundidad de sentada. Creado para ser protagonista, nos permite colocarlo en el centro de una habitación sin perder la imagen que expresa: comodidad y ligereza. Opción de brazo y respaldo desmontables bajo petición.

*The Alan sofa is timeless and at the same time linked to the latest design trends. Its strength lies in the comfort, hence the large number of cushions, which allow playing with the depth of the seat. Designed to be a protagonist, which allows us to place it in the centre of a room without losing the image it expresses: comfort and lightness. Optional detachable arm and backrest on request.*

Le canapé Alan est intemporel et en même temps lié aux dernières tendances du design. Sa force réside dans le confort, d'où le grand nombre de coussins, qui permettent de jouer avec la profondeur du siège. Conçu pour être un acteur majeur, ce qui nous permet de le placer au centre d'une pièce sans perdre l'image qu'il exprime: confort et légèreté. Accoudoir et dossier amovibles en option sur demande.



## OP.1

(arm with cushion)

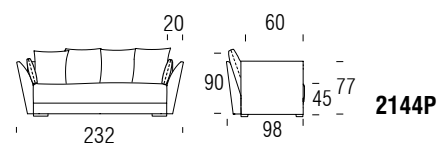

## OP.2

(arm with roller)

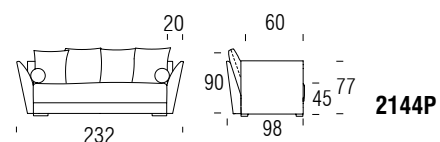



.**AXIS** sofa, black nickel finish legs. Dimensions CM (186x105 H89) + (pouff 90x90 H42) + (186x105 H89).

.**EVEN** armchairs, oak finish legs. Dimensions CM 90x73 H87.

.**EVEN** side table, white marble and oak finish wood. Dimensions CM 122x122 H33.



# Axis

D. E. Gagliardini

Axis busca la esencia de los objetos para convertirse en un poderoso signo de expresión. A través de la depuración de la forma se obtiene un modelo de líneas exactas en las que aparece el movimiento del brazo para explorar diferentes posiciones. Además sus características almohadas proporcionan al usuario un confort espectacular. Brazo con bisagra fácil de desmontar.

*Axis seeks the essence of the objects to become a powerful sign of expression. Through the refining of shapes we obtain a model of precise lines in which the movement of the arm in which we see the different and convenient positions at one's disposal. Additionally, its characteristic cushions grant the users an outstanding comfort level. The arms with hinges are easily removed.*

Axis cherche l'essence des objets pour se transformer en un signe puissant d'expression. Au travers de l'épuration des formes on obtient un modèle avec des lignes exactes dans lesquelles le mouvement du bras apparaît pour explorer différentes positions. De plus ses oreillers spécifiques fournissent à l'utilisateur un confort spectaculaire. Accoudoir avec charnière facile à enlever.

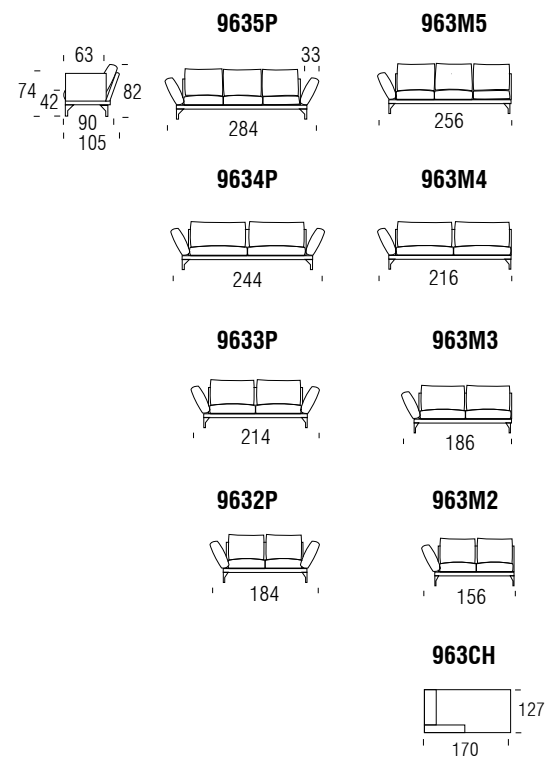



# Basik

Arbel



**Basik, modelo de líneas rectas y elegantes, acorde con gustos formales contemporáneos. Sofá de amplia variedad modular, permitiendo todo tipo de composiciones para el hogar. Incluye un cojín de decoración (47x43 cm) por cada brazo. Sofá o módulo mayor de 200 cm está preparado para que los brazos puedan ser desmontados en destino.**

*Basik, model with straight and elegant lines, consistent with contemporary formal tastes. A sofa range with wide modular variety, allowing for all kinds of combinations in the home. It includes a throw cushion (47 x 43 cm) for each arm. Sofa or module greater than 200 cm is prepared so that arms can be removed on delivery.*

*Basik, modèle aux lignes droites et élégantes, en accord aux goûts formels contemporains. Canapé d'une grande variété modulaire qui permet tous les types de compositions pour la maison. Coussins de décoration (47x43cm) inclus pour chaque accoudoir. Les canapés et les modules de plus de 200 cm sont préparés pour que les accoudoirs puissent être démontés pour la livraison.*

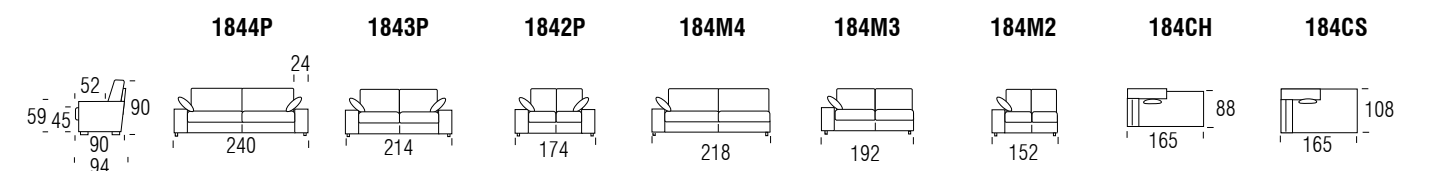



**.COOL** sofa, hidden legs. Dimensions CM (128x97 H82) + (100x97 H82) + (128x97 H82).

**.DELP** armchair, hidden legs. Dimensions CM 82x74 H70.

**.RUND** side tables, oak finished. Dimensions CM (96x96 H40) + (96x60 H37) + (96x60 H33).

# Cool

Arbel

Cool es un modelo que destaca por su funcionalidad y por la amplia variedad de combinaciones que se pueden obtener a partir de sus módulos. Su sencillez invita a jugar con los colores y las texturas. Es una apuesta por el confort y por el diseño que se unen para obtener un modelo en donde estética y durabilidad se convierten en la característica principal del sofá.

	<b>201EP</b>	<b>201ME</b>
	<b>2011P</b>	<b>201M1</b>
	<b>201ES</b>	
	<b>2011S</b>	
	<b>201CH</b>	
	<b>201CS</b>	
	<b>201RI</b>	
	<b>201PR</b>	



*Cool is a model that stands out for its functionality and the wide variety of combinations that can be obtained from its modules. Simplicity invites you to play with colours and textures. It is an endeavour to bring together comfort and design coming together to obtain a model where aesthetics and durability become the main feature of the sofa.*

*Cool est un modèle qui se distingue par sa fonctionnalité et par la grande variété de combinaisons qui peuvent être obtenues à partir de ses modules. Sa simplicité invite à jouer avec les couleurs et les textures. C'est une solution pour le confort et pour le design que l'on unit pour obtenir un modèle où esthétique et durabilité deviennent les caractéristiques principales du canapé.*



# Cosy

Arbel



**OP.2**  
(arm without cushion)

Grandes y confortables almohadas, diseñadas para envolverte durante el descanso. Materiales de la máxima calidad, como núcleos de muelles ensacados o poliuretanos de alta densidad perforados, destinados a ofrecer comodidad y durabilidad. Todo esto en consonancia con un diseño soberbio, robusto, pero sin descuidar los detalles como dobles costuras, fruncidos clásicos, patas modeladas en madera maciza. Cosy todo un sofá con mayúsculas.

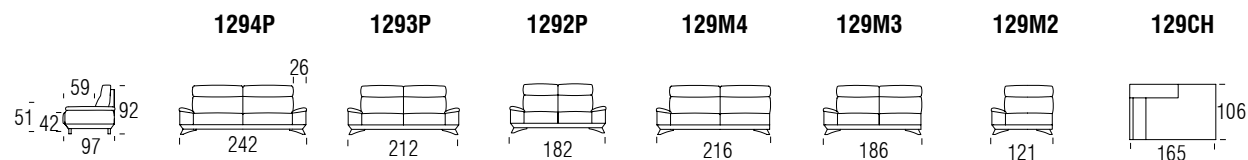

**OP.1**  
(arm with cushion)

*Large and comfortable cushions, designed to wrap around you whilst resting. The highest quality materials, such as nuclei of pocket springs or perforated high density polyurethane, designed to offer comfort and durability. All this is in line with a superb, rugged design, but without neglecting the details as double seams, classic gathers and solid wood legs. Cosy is a sofa with capital letters.*

Oreillers grands et confortables, conçus pour s'impliquer pendant le repos. Matériaux de haute gamme, tels que les noyaux de ressort ensachage ou polyuréthane de haute densité perforé, conçu pour offrir confort et durabilité. Tout cela avec une conception superbe, robuste, mais sans négliger les détails comme les coutures doubles, fronces classiques, pieds tournés en massif. Cosy, un canapé monumental.





.EDAI sofa, OP1 separated pillows, stainless steel legs. Dimensions CM 258x100 H95.

.OFRE armchair, black finish legs. Dimensions CM 74x86 H88.

.GIB side tables, walnut finished. Dimensions CM (120x70 H39,5) + (90x90 H34,5).



# Edai

D. E. Gagliardini



Edai



El sofá Edai es una variante del modelo Wing, que se concibe como un producto lineal gracias a su respaldo unido que despegga del suelo. Todo su volumen se presenta sustentado únicamente por unas patas en los extremos. Este modelo aúna belleza y practicidad, con una estética trabajada que no deja de lado la técnica, un sofá dinámico de líneas sencillas, contemporáneo y a la vez atemporal. Las almohadas respaldo pueden ser separadas (OP.1) o unidas (OP.2).

*The Edai sofa is a variant of the Wing model, which is conceived as a linear product thanks to its attached backrest that detaches from the floor. All its volume is supported only by some legs at the ends. This model combines beauty and practicality, with a sophisticated aesthetic that does not neglect technique, a dynamic sofa with simple lines, contemporary and timeless at the same time. The backrest pillows can be separated (OP.1) or joined (OP.2).*



OP.1

*Le canapé Edai est une variante du modèle Wing, qui est conçu comme un produit linéaire grâce à son dossier fixe qui se détache du sol. Tout son volume n'est soutenu que par quelques pattes aux extrémités. Ce modèle allie beauté et praticité, avec une esthétique qui ne néglige pas la technique, un canapé dynamique aux lignes simples, contemporain et intemporel à la fois. Les coussins de dossier peuvent être séparés (OP.1) ou joints (OP.2).*



OP.2

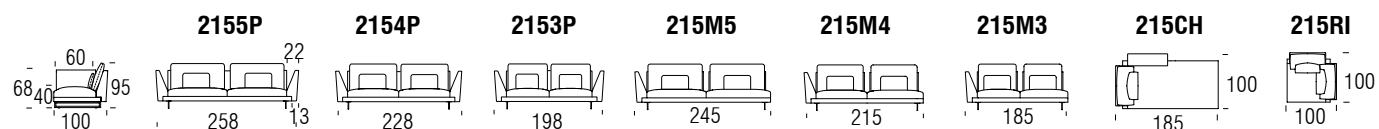



**EGOS** sofa, OP.2 arm, wengue finish legs. Dimensions CM 204x99 H100.

**KIDA** armchair, wengue finish legs. Dimensions CM 82x74 H70.

**DOMO** side table, ash finished. Dimensions CM Ø100 H38.

**HERA** side table, ash finished. Dimensions CM Ø45 H70.

# Egos

Arbel



Egos ideado para vestir espacios actuales y armónicos en los que los detalles son de gran importancia. Posibilidad de elegir entre dos tipos diferentes de brazos. Sofá o módulo mayor de 200 cm está preparado para que los brazos puedan ser desmontados en destino. Incluye una almohada por cada brazo (37x47cm). Opción de asiento y respaldo deslizante, de gran apertura, el respaldo avanza junto con el asiento adoptando la inclinación adecuada.

*Egos designed to adorn contemporary and harmonic spaces in which the details are of great importance. With the possibility of choosing between two different types of arms. Sofa or modules greater than 200 cm are prepared so that arms can be removed on site. Includes a throw cushion for each arm (37x47cm). Option: sliding seat and backrest, moving together into a reclining position.*

Egos imaginé pour habiller les espaces actuels et harmoniques dans lesquels les détails sont d'une grande importance. Possibilité de choisir entre deux différents types d'accoudoirs. Les canapés et les modules de plus de 200cm sont préparés pour que les accoudoirs puissent être démontés lors de la livraison. Coussins de décoration (37x47cm) inclus pour chaque accoudoir. Assise optionnelle et dossier glissant de grande ouverture. Le dossier avance en même temps que l'assise et adopte l'inclinaison nécessaire.

OP1  
18



OP2  
12



1905P

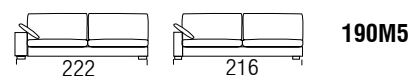

190M5

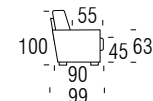

190CR

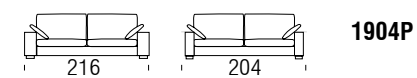

1904P

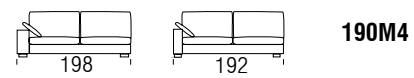

190M4

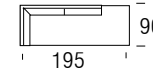

190M3

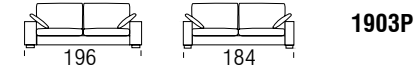

1903P

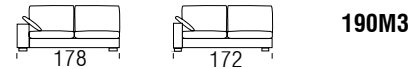

190M2

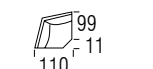

190RI

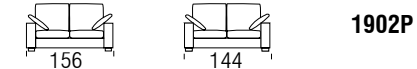

1902P



190M1

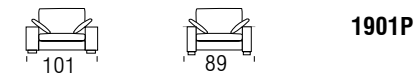

1901P



190ME





.EMUC sofa, OP.1 arm, oak finish legs. Dimensions CM 240x99 H100.

.ALMA armchair, oak finish legs. Dimensions CM 75x80 H105.

.GIB side tables, walnut finished. Dimensions CM (120x70 H39,5) + (90x90 H34,5).

# Emuc

Arbel



**Emuc modelo en el que destaca las formas redondeadas de sus almohadas, amplios volúmenes que inspiran confort y recogimiento. Este aspecto se logra por el uso del relleno de microfibra tacto plumón (Microgel). Unión de módulos mediante anclaje lateral. Sofá o módulo mayor de 200cm está preparado para que los brazos puedan ser desmontados en destino.**

*Emuc a model in which emphasises the rounded shapes of its cushions, large body that inspires comfort and seclusion. This aspect is achieved by using down touch microfibre filling (Microgel). Modules joined by lateral anchorage. Sofa or modules greater than 200cm are prepared so that arms can be removed on site.*

*Le modèle Emuc se fait remarquer par les formes arrondies de ses coussins, son ample volume qui inspire confort et recueillement. Cet aspect s'obtient par l'utilisation du rembourrage de microfibre toucher duvet (Microgel). Union des éléments par ancrage latéral. Les canapés et les modules de plus de 200cm sont préparés pour que les accoudoirs puissent être démontés lors de la livraison.*

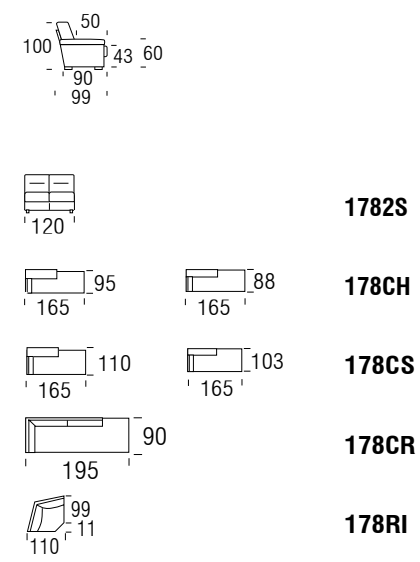
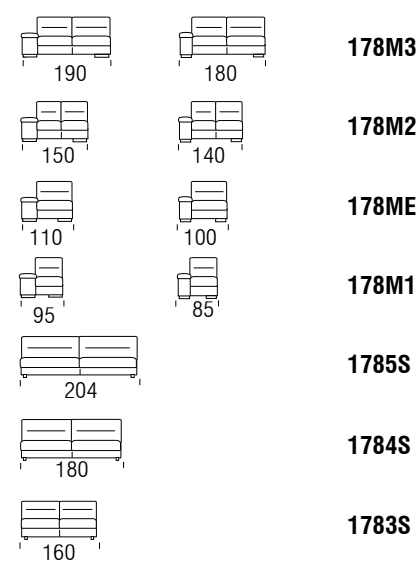
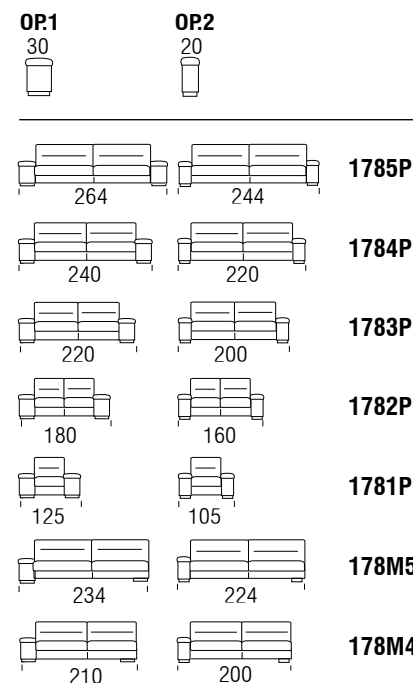



.ERIK sofa, chromed legs. Dimensions CM 325x125 H95 (167x100 H95) + (167x100 H95).

.ERIK armchair, steel legs. Dimensions CM 80x90 H69.

.EVEN side table, white marble and oak finish wood. Dimensions CM 122x122 H33.

.FRES side table, ash finished. Dimensions CM Ø36 H56.



# Erik

D. E. Gagliardini

**Esta propuesta tiene como objetivo el resultado de una síntesis entre la innovación y el clasicismo, que se caracteriza por la posibilidad de crear un acogedor espacio entorno al sofá, gracias a su geometría. El conjunto brazo-respaldo destaca su diseño, por el deseo de ofrecer un toque diferenciador, moderno.**

*Erik, this design aims toward a mix of innovation and classicism, which is characterized by the ability to create a warm environment around the sofa, thanks to its geometry. The combination of arm and backrest highlights its design, with a desire to offer a distinctive and modern touch.*

*Erik, cette proposition a pour objectif d'être une synthèse entre innovation et le classicisme, qui se caractérise par la possibilité de créer un espace confortable autour du canapé, grâce à sa géométrie. L'ensemble accoudoir-dossier met en évidence sa conception, avec la volonté d'offrir une touche distinctive et moderne.*

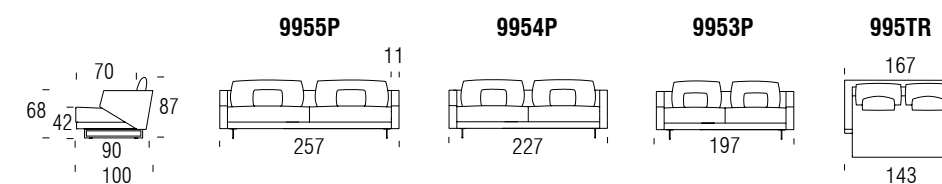



**GUES** sofa, OP1 separated pillows, walnut finish legs. Dimensions CM 244x100 H74.

**.BLOM** armchair, walnut finish legs. Dimensions CM 73x89 H94.

**.RUND** side tables, oak finished. Dimensions CM (Ø70 H40) + (Ø48 H33).



# Gues

Arbel



OP.2

La construcción sencilla y robusta, junto a sus líneas naturales y básicas, convierten a Gues en un producto con carácter atemporal. Su amplitud de almohadas y un buen equilibrio entre firmeza y comodidad, invitan al descanso. Además, su diseño con simetría entre brazo y respaldo, ofrecen la posibilidad de crear multitud de combinaciones. Las almohadas respaldo pueden ser separadas (OP.1) o unidas (OP.2).

Simple yet robust construction, together with its natural and basic lines, make Gues a product with timeless character. Its breadth and a good balance between firmness and comfort, invite you to rest. In addition, its design with symmetry between arm and back, along with an extensive range of different components, offer the possibility of creating numerous combinations. The backrest pillows can be separated (OP.1) or joined (OP.2).

Sa construction simple et robuste, avec ses lignes naturelles, font de Gues un produit au caractère intemporel. Ses oreillers et un bon équilibre entre fermeté et confort, vous invitent au repos. En plus, son design avec une symétrie entre l'accoudoir et le dos, ainsi qu'une large gamme d'éléments, offrent la possibilité de créer plusieurs combinaisons. Les coussins de dossier peuvent être séparés (OP.1) ou joints (OP.2).

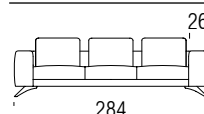

9965P

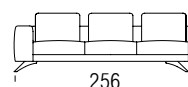

996M5

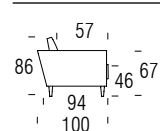

996CH

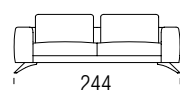

9964P

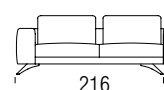

996M4

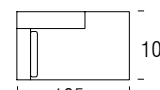

996RI

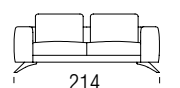

9963P

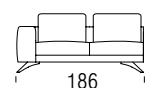

996M3

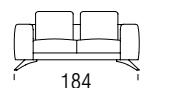

9962P

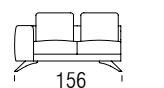

996M2





.ILUM sofa, OP1 (1 seat cushion). Dimensions CM 246x103 H85.

.ARKO armchair, steel baseboard. Dimensions CM 82x70 H71.

.LAYA side table, white marble and walnut finish wood. Dimensions CM 120x70 H40.

.LUXU side tables, iroko finish. Dimensions CM (Ø50, H42) + (Ø40 H34).

# Ilum

D. E. Gagliardini

Ilum es un sofa que propone la vuelta a los cánones clásicos de esta tipología, hasta el punto de que algunos componentes pierden su propia volumetría disolviéndose en una serie de almohadones. Un alma clásica traducida a un lenguaje contemporáneo a través del recurso de la línea y la forma. La comodidad es su lenguaje original. Un sofá de aspecto desenfadado, bohemio y elegante. Sofá desenfundable.

*Ilum is a sofa that proposes a return to the classic canons of its typology, to the point that some components lose their own volumetry, dissolving into a series of cushions. A classic soul translated into a contemporary language through the use of line and form. Comfort is its original language. A sofa with casual, bohemian and elegant look. Removable covers.*

Ilum est un canapé qui propose un retour aux canons classiques de cette typologie, au point que certains éléments perdent leur propre volumétrie, se décomposant en une série de coussins. Une âme classique traduite dans un langage contemporain au travers de l'utilisation des lignes et des formes. Le confort est sa langue d'origine. Un canapé au look décontracté, bohème et élégant. Canapé déhoussable.

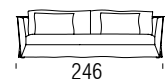
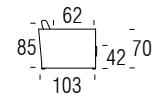

2165P



2164P

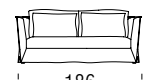

2163P



2161P



216M4



216M3

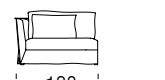

216ME

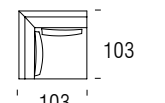

216RI



OP.1



OP.2





# Inside

Rafa García, Miguel Ángel García

**Formas dinámicas y vanguardistas distinguen a la chaise-longue Inside. Pieza de líneas marcadas de estudiada ergonomía, expresa una fuerte personalidad que no deja indiferente. Producto galardonado y reconocido por el sector del mueble; 3º premio en el Concurso de Diseño del Mueble, Region de Murcia.**

Dynamic and avant-garde shapes distinguish the Inside chaise longue. A piece with striking ergonomic shapes expressing a powerful personality to which you cannot be indifferent. Product awarded and recognized by the furniture industry; 3rd Prize in the Furniture Design Competition in the Region of Murcia.

Des formes dynamiques et d'avant-garde distinguent la chaise longue Inside. Produit aux lignes marquées et à l'ergonomie soignée, elle exprime une forte personnalité qui ne laisse pas indifférent. Produit lauréat et reconnu par le secteur du meuble; 3ème prix du Concours de Design du Meuble, Région de Murcia.

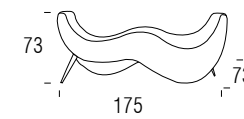

1251P





**.INUA** sofa, walnut finish legs. Dimensions CM (203x98 H86) + (98x98 H86) + (162x98 H86).

**.ADEX** armchair, stainless steel frame. Dimensions CM 82x75 H73.

**.ICON** side table, oak finished. Dimensions CM Ø100 H36.

**.DOMO** side table, black marble. Dimensions CM Ø45 H50.

# Inua

Arbel



**INUA ha sido diseñado para adaptarse a las necesidades de nuestros tiempos teniendo en cuenta todos los detalles del producto y la fabricación de muebles tapizados. Presenta un aspecto contemporáneo pensando en todo tipo de espacios. El respaldo elevable proporciona la comodidad óptima de un respaldo alto, por el apoyo completo de nuestra espalda. Su amplia sentada y sus dimensiones han sido desarrolladas pensando siempre el confort sin dejar de lado la estética.**

INUA has been designed to adapt to the needs of our time having in mind all the product details and the manufacture of upholstered furniture. It has a contemporary appearance in all kind of spaces. The liftable backrest adds the optimal comfort of a high backrest, thanks to the full rest of our back. Its wide seat and its dimensions have been developed thinking on the comfort without putting the aesthetic aside.

INUA a été conçu pour s'adapter aux besoins de notre époque, en tenant compte de tous les détails du produit et la fabrication de meubles rembourrés. Il a une apparence contemporaine pour tous les types d'espaces. Le dossier relevable donne le confort optimal d'un dossier haut, par le soutien total de notre dos. Son ample assise et ses dimensions ont été développées en pensant toujours au confort sans oublier l'esthétique.

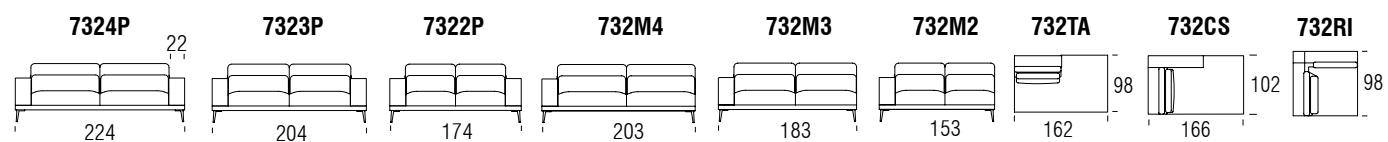
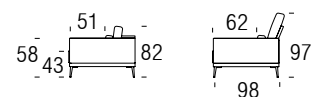



# Kota

Arbel

**Kota se caracteriza por las líneas ligeras de su base que unifica el conjunto en una sola pieza dotando al producto de personalidad y elegancia. Ergonomía, estética y funcionalidad caracterizan al modelo Kota. Un sofá clásico en su concepto y contemporáneo en sus proporciones, indispensable en los espacios actuales. La forma de la almohada respaldo aporta gran estabilidad a la zona cervical.**

*Kota is characterized by the lightweight shape of its base that unifies the whole Group in a single piece endowing the product with personality and elegance. Ergonomics, aesthetics and functionality characterize the Kota model. A sofa classic in its concept and contemporary in its proportions, indispensable in the current environments. The shape of the backrest cushion provides great stability to the neck region.*

*Kota est caractérisée par les lignes légères de sa structure qui unifie l'ensemble dans une seule pièce, ce qui donne au produit personnalité et élégance. Ergonomie, esthétique et fonctionnalité caractérisent le modèle Kota. Un canapé classique dans le concept et contemporain dans ses proportions, indispensable dans les espaces actuels. La forme du coussin de dossier fournit une grande stabilité à la zone cervicale.*

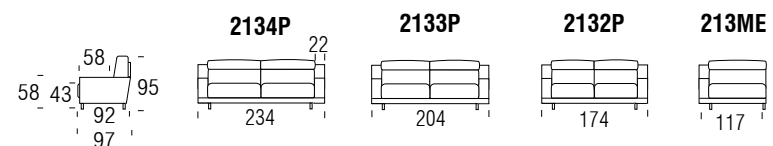



# Lobi

Arbel



**Elegante y señorial son los adjetivos que mejor definen a Lobi, un sofá cuyo distinguido diseño lo convierten en una pieza para vestir espacios de marcado estilo vintage. Su amplia modularidad permite crear composiciones que se adapten a cualquier espacio.**

*Elegant and stately are the adjectives that best define Lobi, a sofa whose distinguished design makes it a piece to furnish spaces in a classic style. Its broad modular design allows the creation of combinations that adapt to any space.*

*Majestueux et élégant sont les adjectifs qui définissent Lobi, un canapé avec un concept distingué idéal pour des espaces vintage. Sa grande modularité permet de créer des compositions qui s'adaptent à tout espace.*

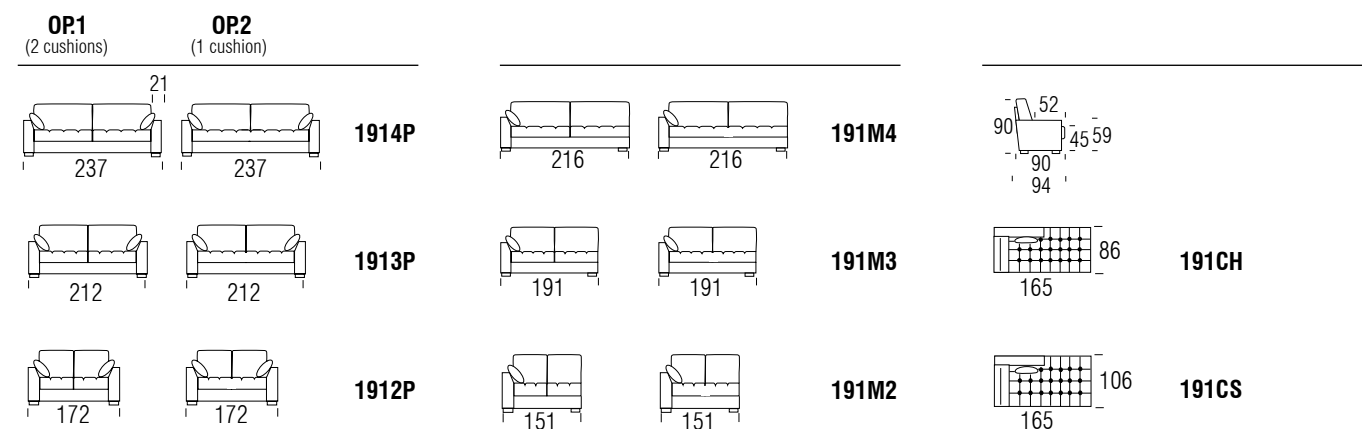





.LOFT sofa. Dimensions CM 246x103 H85.

.ERTO armchair, walnut finish base. Dimensions CM 64x68 H97.

.AGOL side table, oak finish. Dimensions CM 150x90 H37

.OPOF pouffs. Dimensions CM Ø48 H62.

# Loft

Arbel

**Loft, un sofá distinto, complejo en cuanto a su concepto de partida pero con un resultado impecable. Un alma clásica traducida a un lenguaje contemporáneo a través del recurso de la línea y la forma. Un estimulante ejercicio de exploración de la vanguardia formal. En su ejecución reside su alma, y la comodidad es su lenguaje original. Un sofá de aspecto desenfadado, bohemio y elegante. Sofá desenfundable.**

*Loft, a different sofa, complex in terms of its initial concept but with an impeccable result. A classic spirit translated into a contemporary language through the use of line and shape. A stimulating exercise in the exploration of the formal avant-garde. In the execution resides its soul, and comfort is its style. A sofa with a casual, bohemian and stylish look. Removable covers.*

*Loft, un canapé différent, complexe au niveau de son concept initial, mais avec un résultat impeccable. Une âme classique traduite dans un langage contemporain grâce à l'utilisation de la ligne et la forme. Un exercice stimulant dans l'exploration de l'avant-garde. Son âme réside dans sa mise en oeuvre, et le confort est son style. Un canapé en apparence décontracté, bohème et élégant. Canapé déhoussable.*

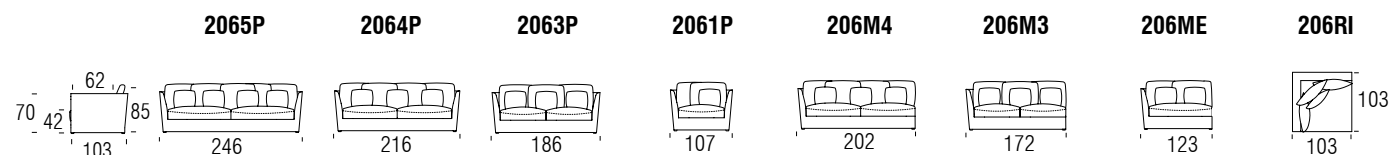



.MUSA sofa, OP2, wengue finish legs. Dimensions CM 240x99 H90.

.ECKO armchairs. Dimensions CM 72x74 H65.

.LUNA side table, white marble. Dimensions CM 140x100 H34.

.SOFT pouffs. Dimensions CM (100x100 H43) + (70x70 H43).

# Musa

Arbel



OP.1

Musa



OP.2

Musa, sofá de aspecto clásico, los grandes brazos cilíndricos y las patas torneadas le hacen idóneo para la decoración de los entornos más conservadores. Ofrece la posibilidad de elegir dos tipos de respaldo, Op1 almohada grande convencional, Op2 cojines (66x66) de estilo más informal.

*Musa, a classically shaped sofa. Large cylindrical arms and turned legs make it ideal for the decor of more conservative environments. Offers the possibility to choose one of two types of back rest, Op1 conventional large cushion, Op2 cushion (66 x 66) with a more informal style.*

Musa, canapé au style classique, les grands accoudoirs cylindriques et les pieds tournés le rendent idéal pour la décoration des ambiances plus traditionnelles. Il offre la possibilité de choisir deux types de dossiers, Opt.1 grand coussin traditionnel, Opt.2 coussins (66x66) de style plus informel.

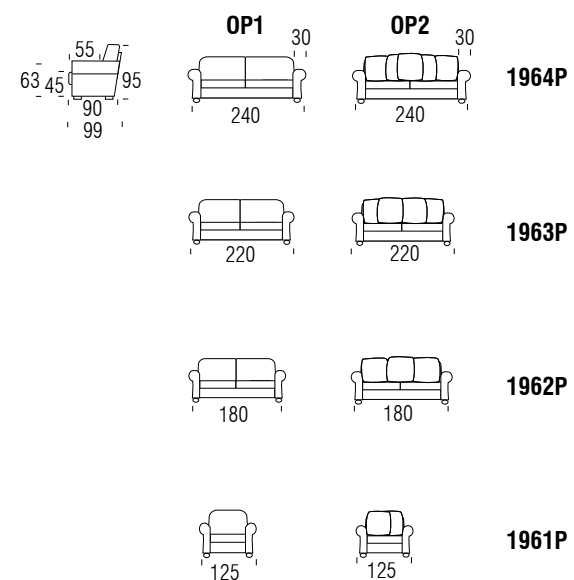



**.MUST** sofa. Dimensions CM 217x100 H80.

**.ADEX** armchair, glossy black frame. Dimensions CM 82x75 H73.

**.DOMO** side tables, black marble. Dimensions CM (Ø100 H38) + (Ø45 H50).



# Must

Javier Herrero

**Must es un sofá de espíritu minimalista e innovador, que respira ligereza. Está regido por formas limpias y una gran atención al detalle. Sofisticado y atractivo, digno en su diseño pero muy versátil, adecuado para cualquier ambiente, tanto en un espacio formal como en un lugar más relajado. Una pieza llena de detalles que brillan al aprovechar al máximo las posibilidades de un buen diseño y unos materiales de máxima calidad.**

*Must is a sofa with a minimalist and innovative spirit, which breathes lightness. It is ruled by clean forms and a great attention to detail. Sophisticated and attractive, worthy in its design but very versatile, suitable for any environment, either in a formal space or in a more relaxed place. A piece full of details that shine by making the most of the possibilities of good design and top quality materials.*

*Must est un canapé à l'esprit minimaliste et novateur, qui respire la légèreté. Il est régi par des formes épurées et une grande attention aux détails. Sophistiqué et attrayant, digne dans sa conception mais très polyvalent, il s'adapte à tout environnement, aussi bien dans un espace formel que dans un lieu plus détendu. Une pièce pleine de détails qui brillent en tirant pleinement parti des possibilités d'un bon design et de matériaux de haute qualité.*

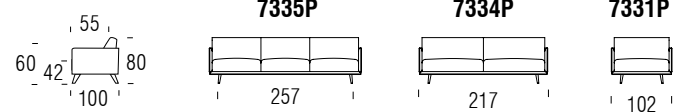



.NIMO sofa, oak finish legs. Dimensions CM 224x99 H100.

.DELTA armchair, black finish base. Dimensions CM 80x77 H103.

.GIB side table, walnut finish. Dimensions CM 90x90 H34.5.

.IGNO side tables, walnut finish wood. Dimensions CM (Ø45 H56) + (Ø36 H44).

# Nimo

Arbel



**Nimo, modelo de línea actual en el que las formas compactas le atribuyen solidez y confort. El asiento, de gran espesor, ofrece una sentada elástica que se adapta a la perfección a distintas anatomías. Destacan los acabados de esta pieza, costuras y vivos cuidados hasta el más mínimo detalle que enmarcan y aligeran las formas de este sofá.**

*Nimo, a model with contemporary line in which the compact shapes confer strength and comfort. The deep seat cushion features an elastic seating that adapts perfectly to different anatomies. The finishing touches of this piece stand out, with stitching and edges attending to the smallest detail that marks out and highlights the shape of this sofa.*

*Nimo, le modèle est d'une ligne actuelle avec des formes compactes qui lui ajoute solidité et confort. Le siège, d'une grande épaisseur, offre une assise élastique qui s'adapte à la perfection aux différentes anatomies. Son aspect se fait remarquer par sa finition, comme les coutures jusqu'au plus minuscules détails qui encadrent et allègent les formes de ce canapé.*

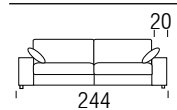

**1955P**

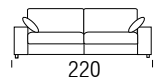

**1954P**

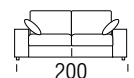

**1953P**

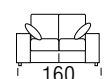

**1952P**



**1951P**



**195M5**



**195M4**



**195M3**



**195M2**



**195ME**



**195M1**

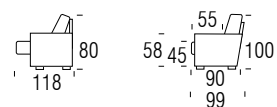

**195CH**

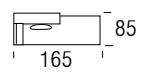

**195CS**



**195CR**



**195RI**







**OLIV** sofa, black nickel finish legs. Dimensions CM 213x97 H95.

**PUNK** armchair, wengue finish base. Dimensions CM 64x67 H82.

**ICON** side table, oak finish. Dimensions CM Ø120 H36.

# Oliv

M. E. Puche



**Oliv, sofá contemporáneo con un sabor clásico. Esta pieza guarda el equilibrio perfecto de proporciones, con una discreta presencia, que no obstante, irradia un halo de comodidad y amplitud. Su destacable confort se debe, principalmente, a la placentera suavidad de su tapizado, que te envuelve completamente y evita el contacto directo con los elementos estructurales más duros.**

*Oliv, contemporary sofa with a classic taste. This piece keeps the perfect balance of proportions, with a discreet presence, which nevertheless radiates a halo of comfort and spaciousness. Its outstanding comfort is mainly due to the pleasant softness of its upholstery, which completely surrounds you and avoids direct contact with the hardest structural elements.*

*Oliv, canapé contemporain au goût classique. Ce canapé propose un équilibre parfait des proportions, avec une présence discrète qui diffuse néanmoins un halo de confort et d'espace. Son confort exceptionnel est principalement dû à l'agréable douceur de son rembourrage, qui vous entoure complètement et évite le contact direct avec les éléments structuraux les plus durs.*

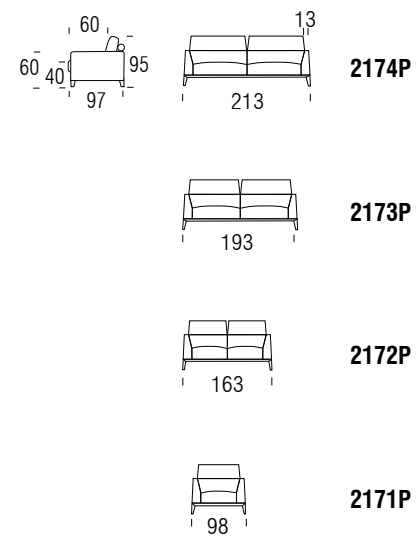



.SLIM sofa, black nickel finish legs, OP1 separate backrest cushions. Dimensions CM 250x100 H86.

.TAMO armchair, black nickel finish frame. Dimensions CM 70x80 H80.

.DOMO side tables, black marble. Dimensions CM (Ø100 H38) + (Ø45 H50).

# Slim

Arbel



Attached backrest cushions. **OP.2**

**Slim, un sofá ligero, horizontal, elegante; y sin embargo no está regido por la geometría sino por el arte. El detalle se convierte en la mejor forma de convertir un objeto casual en un objeto atemporal. Un modelo con una gran variedad modular que ha sido concebido como una solución práctico-estética para los usuarios conocedores de la importancia de un buen diseño.**

*Slim, a lightweight and elegant sofa; and however it is not governed by the geometry but by art. The detail becomes the best way to convert a casual object in a timeless one. A model with a wide modular variety that has been conceived as a practical yet aesthetic solution for users who know the importance of a good design.*

*Slim, un canapé léger, horizontal, élégant et cependant il n'est pas régi par la géométrie, mais par l'art. Le détail devient la meilleure façon de faire d'un objet occasionnel un objet décontracté. Un modèle avec une gamme modulaire qui a été conçue comme une solution pratique-esthétique pour les utilisateurs familiarisés avec l'importance de la bonne conception.*

		<b>9805P</b>
		<b>9804P</b>
		<b>9803P</b>
		<b>9802P</b>
		<b>9801P</b>
		<b>980TB</b>
		<b>980M5</b>
		<b>980M4</b>
		<b>980M3</b>
		<b>980M2</b>
		<b>980M1</b>
		<b>9805S</b>
		<b>9804S</b>
		<b>9803S</b>
		<b>9802S</b>
		<b>9801S</b>
		<b>980TD</b>
		<b>980CH</b>
		<b>980RI</b>

## Slim





**.SUIT** sofa. Dimensions CM (142x105 H80) + (115x105 H80) + (175x105 H80).

**.PAO** armchairs, walnut finish legs. Dimensions CM 70x73 H71.

**.LAYA** side table, black marble and walnut finish wood. Dimensions CM 150x90 H40.

**.IGNO** side tables, black marble and walnut finish wood. Dimensions CM (Ø45 H56) + (Ø36 H44).

# Suit

Robert Ortega



**Suit, un modelo que ofrece una amplia variedad de módulos para conseguir tantas composiciones como necesite el cliente. Suit sin embargo no es un sofá modular al uso; Suit es un claro ejemplo de nuestro saber hacer, de nuestro gusto por la confección esmerada y es un reflejo de como nuestros artesanos son capaces de dar personalidad a la sencillez.**

*Suit, a model that offers a wide variety of modules to get as many configurations as the client needs. Suit however is not a modular sofa in use; Suit is a clear example of our knowledge, our taste for careful preparation and is a reflection of how our craftsmen are able to give personality to simplicity.*

*Suit, un modèle qui propose une grande variété de modules pour obtenir tant autant de compositions possibles que le client a besoin. Cependant, Suit n'est pas qu'un canapé modulable; Suit est un clair exemple de notre savoir-faire, notre goût pour la fabrication minutieuse et il est le reflet de comment nos artisans sont capables de donner de la personnalité à la simplicité.*

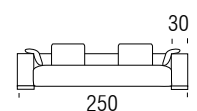

**9814P**

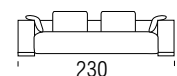

**9813P**

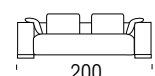

**9812P**

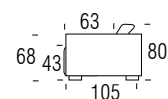

**981M4**

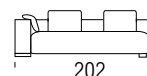

**981M3**

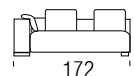

**981M2**



**981M1**

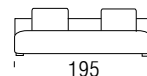

**9814S**

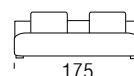

**9813S**

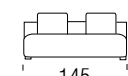

**9812S**



**9811S**

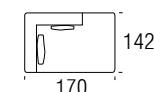

**981CS**

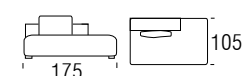

**981TA**

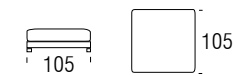

**981PR**

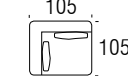

**981RI**





.WELL sofa, ash finish legs. Dimensions CM 200x92 H80.

.ECKO armchair. Dimensions CM 72x74 H65.

.BACK side table, oak finish wood. Dimensions CM Ø50 H50.

.HERA side table, ash finish wood. Dimensions CM Ø45 H70.

# Well

Javier Herrero

**Well, un sofá caracterizado por sus formas curvas y su elegante aspecto tecnológico. La estructura y los cojines parecen flotar sobre las elegantes patas torneadas. El sofá Well se basa en formas orgánicas, con contornos fluidos de asiento y respaldo, que lo convierten en una pieza cómoda que sostiene y abraza a los usuarios. El suave cuerpo de esta pieza descansa sobre unas delicadas patas de madera maciza torneada que consiguen que parezca realmente ligero.**

*Well, a sofa characterized by its curved shape and its elegant technological aspect. The structure and the cushions seem to float on the elegant turned legs. The Well sofa is based on organic forms, with fluid contours of the seat and back, which make it a comfortable piece rests on delicate legs made of solid turned wood that make it look really light.*

**Well, un canapé caractérisé par ses formes courbes et son aspect technologique élégant. La structure et les coussins semblent flotter sur les élégants pieds tournés. Le canapé Well est basé sur des formes organiques, avec des contours fluides de l'assise et du dossier, qui en font une pièce confortable qui soutient et embrasse les utilisateurs. Le corps souple de ce canapé repose sur des pieds délicats en bois massif tourné qui lui donnent un aspect très léger.**

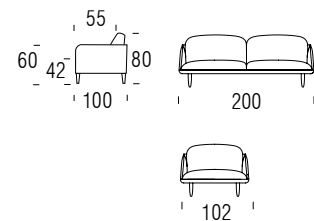

2184P

2181P







**.WING** sofa, chromed finish legs. Dimensions CM (245x100 H95) + (100x100 H95) + (203x100 H95) + (233x100 H95).

**.DELP** armchair. Dimensions CM 82x74 H70.

**.ICON** side table, oak finish. Dimensions CM Ø120 H36.

**.FRES** side tables, ash finish. Dimensions CM (Ø41 H60) + (Ø36 H56).



# Wing

Arbel

**Wing, un sistema de tapizados que permite una gran flexibilidad a partir de la bancada, como elemento básico, y añadiendo elementos, tales como los brazos y los respaldos, para formar configuraciones que cumplen con los requisitos de poder personalizar o eligiendo en las composiciones sugeridas. No es un sofá, sino un sistema de asientos en los que su identidad es la capacidad de transformarse debido a los elementos intercambiables.**

Wing, a system of upholstery that allows great flexibility starting with the bench as the basic element, and adding elements, such as the arms and back, to create configurations that meet bespoke requirements or choose the recommended arrangements. It is not a sofa, but a seating system in which its identity gives the ability for it to be transformed due to the interchangeable elements.

Wing, un système de rembourrage qui permet une grande flexibilité à partir de l'assise, comme élément de base et en ajoutant les éléments, tels que les accoudoirs et le retour, pour faire les configurations qui satisferont toutes les exigences de personnalisation ou choisir entre les compositions proposées. Il n'est pas un simple canapé, mais un système de sièges dont l'identité est la capacité à se transformer grâce aux éléments interchangeables.

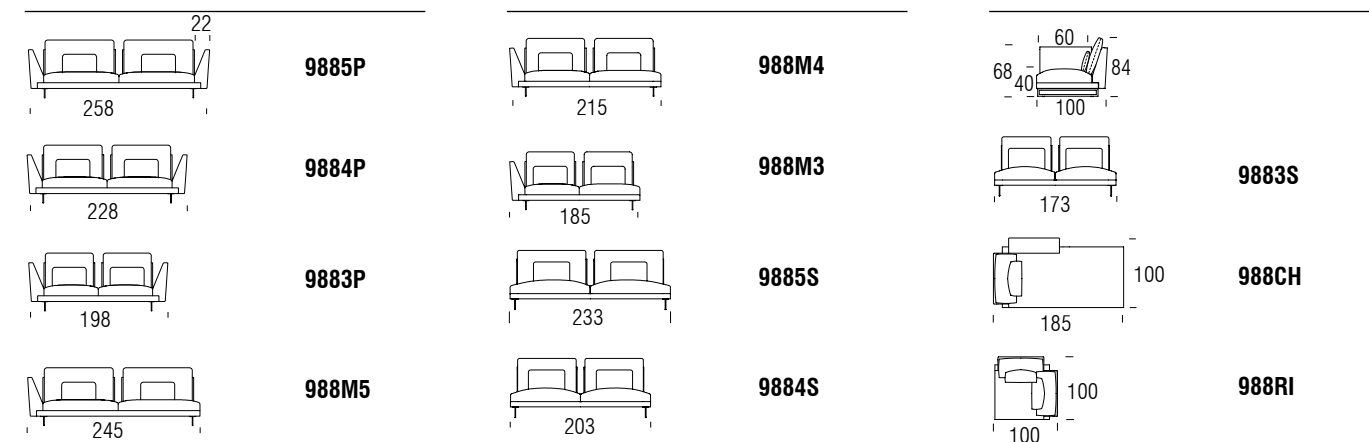

## WE ARE MANUFACTURERS



### HISTORIA



**En 1967**, Francisco Juan y Carmen Ortiz fundan Frajumar. Empresa familiar guiada por un espíritu dinámico y emprendedor que apuesta por la calidad, la innovación y el diseño. Enfocada, desde sus comienzos, a la realización de un producto atemporal sin olvidar el saber tradicional.

*In 1967, Francisco Juan and Carmen Ortiz founded Frajumar. A family business driven by a dynamic and innovative spirit that is focused on quality, innovation and design. From the beginning, it has concentrated on the creation of a timeless product without forgetting traditional knowledge.*

**En 1967**, Francisco Juan et Carmen Ortiz fonde Frajumar. Une entreprise familiale guidée par un esprit dynamique et entrepreneurial qui s'engage en faveur de la qualité, de l'innovation et du design. Depuis ses débuts, elle s'est concentrée sur la création d'un produit intemporel sans oublier les connaissances traditionnelles.

### QUALITY



Beltá Frajumar fabrica en España bajo un Sistema de Gestión de Calidad, **ISO 9001** certificada por Bureau Veritas. Comprometido con la innovación y la calidad, la empresa fabrica sus colecciones con la más estricta exigencia, desde la selección de los materiales hasta los ensayos de seguridad y calidad.

*Beltá Frajumar manufactures in Spain under a Quality Management System, **ISO 9001**, certified by the company Bureau Veritas. Committed to innovation and quality, Beltá Frajumar manufactures its collections with the highest demands, from the selection of materials to safety and quality tests.*

Beltá Frajumar fabrique en Espagne sous un Système de Gestion de la Qualité, **ISO 9001**, certifiés par la société Bureau Veritas. Engagée dans l'innovation et la qualité, Beltá Frajumar fabrique ses collections avec les exigences les plus strictes, de la sélection des matériaux aux tests de sécurité et de qualité.

### SHOWROOM



**Un espacio único**, con ambientes que representan diferentes estancias tanto de un hogar como de un espacio contract: habitaciones, zonas de estar, lounge, bar, restaurantes, donde los clientes que visitan el showroom puedan inspirarse y apreciar la calidad del trabajo e instalaciones, la variedad, conocimiento de materiales y acabados propuestos, además del diseño.

*A unique space, with atmospheres that represent different rooms of a home as well as a contract space: rooms, living areas, lounge, bar, restaurants, where the clients who visit the showroom can be inspired and appreciate the quality of the work and installations, the variety, knowledge of materials and finishes proposed, as well as the design.*

**Un espace unique**, avec des ambiances qui représentent les différentes pièces d'une maison ainsi qu'un espace pour contract: chambres, espaces de séjour, salon, bar, restaurants, où les clients qui visitent le showroom peuvent être inspirés et apprécier la qualité du travail et des installations, la variété, la connaissance des matériaux et des finitions proposés, ainsi que le design.

### ENVIRONMENT



Beltá Frajumar está comprometida con un crecimiento sostenible y de calidad. Poniendo en valor la economía local y social del entorno de la empresa. Avalada por las certificaciones de Bureau Veritas en medio ambiente **ISO14001**. La empresa fabrica productos de larga duración que ayudan al uso responsable de los recursos naturales.

*Beltá Frajumar is engaged in sustainable and quality growth. Putting in value the local and social economy of the company's environment. Endorsed by the certifications of Bureau Veritas in environment **ISO14001**. The company manufactures durable products that support the responsible use of natural resources.*

Beltá Frajumar s'est engagée à assurer une croissance durable et de qualité. En mettant en valeur l'économie locale et sociale de l'environnement de l'entreprise. Approuvé par les certifications du Bureau Veritas en matière d'environnement **ISO14001**. L'entreprise fabrique des produits durables qui soutiennent l'utilisation responsable des ressources naturelles.

Desde **1967**, empresa familiar con más de **50** años de experiencia.

Since 1967, family business with more than 50 years of experience.

Entreprise familiale avec plus de 50 ans d'expérience.

# Daro

Arbel



**Daro, sofá cama de líneas puras con un diseño estudiado que da como resultado un objeto práctico, funcional y bello. Sistema de apertura tipo italiana, Mecanismo de movimiento con apertura frontal mediante rotación del respaldo en un único movimiento. El paso de la posición sofá a la posición cama tiene lugar sin mover o quitar ninguno de los elementos de la tapicería. Posibilidad de guardar las almohadas de la cama en el interior de los respaldos.**

Daro, sofa-bed with pure lines, resulting in a useful, functional and beautiful piece. Italian type opening system. Front opening mechanism by rotating the backrest in a single movement. The sofa is transformed into a bed without removing any upholstered part. Possibility of pillows being stored hidden behind the back rest.

Daro, canapé-lit aux lignes pures et avec un design très étudié qui a comme résultat un objet pratique, facile d'utilisation et joli. Système Italien d'ouverture. Mécanisme de mouvement avec ouverture frontale par rotation du dossier dans un seul mouvement. Le passage de la position canapé à la position lit s'effectue sans déplacement ou suppression d'aucun des éléments. Possibilité de ranger les oreillers à l'intérieur du dossier.

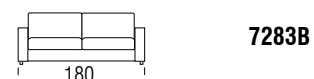
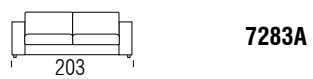
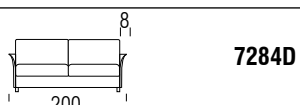
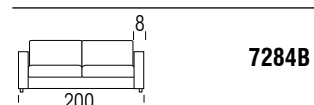
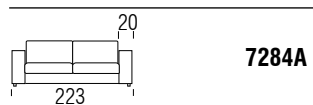
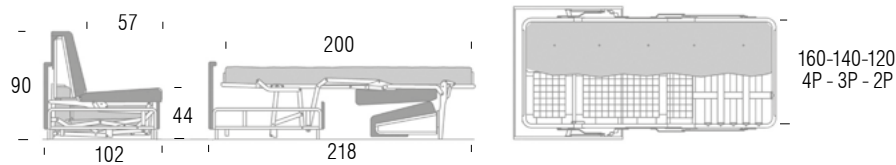



.DUE sofa bed, OP. B. Dimensions CM 200x100 H90.

.FRES side tables, ash finish. Dimensions CM (Ø41 H60) + (Ø36 H56) .



# Due

M. E. Pucho

**Due, sofá cama de una cuidada elegancia, acorde con las tendencias actuales. En su diseño prima la ergonomía, donde la función condiciona la forma. Pensado para todo tipo de espacios, ya sea hogar o espacios contract. Sistema de apertura tipo italiana. Mecanismo de movimiento con apertura frontal mediante rotación del respaldo en un único movimiento. El paso de la posición sofá a la posición cama tiene lugar sin mover o quitar ninguno de los elementos de la tapicería.**

*Due, sofa bed of a careful elegance, according to the current trends. In its design, ergonomics prevails, where the function conditions the form. Thought for all kind of spaces, either home or contract spaces. Italian-style opening system. Movement mechanism with front opening by rotating the backrest in a single movement. The transition from the sofa position to the bed position takes place without moving or removing any of the upholstery elements.*

*Due, canapé-lit d'une élégance soignée, selon les tendances actuelles. Sa conception est basée sur l'ergonomie, où la fonction conditionne la forme. Conçu pour tous les types d'espaces, qu'il s'agisse d'espaces domestiques ou contractuels. Système d'ouverture à l'italienne. Mécanisme de mouvement avec ouverture frontale par rotation du dossier en un seul mouvement. Le passage de la position canapé à la position lit s'effectue sans déplacer ni enlever aucun des éléments de rembourrage.*

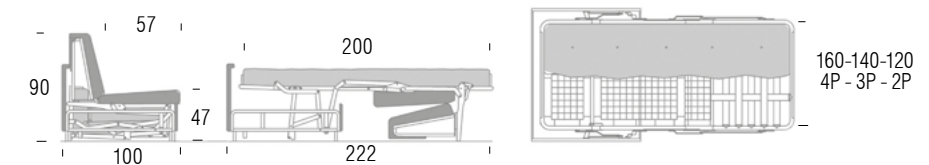

**OP. A**

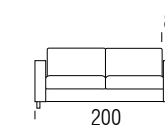

**2204P**

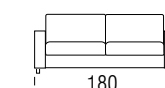

**2203P**

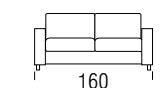

**2202P**

**OP. B**

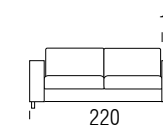

**2204B**

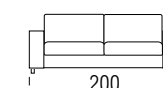

**2203B**

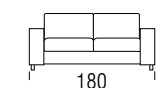

**2202B**



.SPAT sofa bed. Dimensions CM 215x102 H90.

.KORA armchair, black finish legs. Dimensions CM 82x70 H71.

.LUXU side tables, iroko finish wood. Dimensions CM (Ø50 H42) + (Ø40 H34).

# Spat

D. E. Gagliardini

El sofá Spat tiene una forma casi primaria, como si a partir de un material dúctil se crease con un gesto. Sistema de apertura tipo italiana: el paso de la posición sofá a la posición cama tiene lugar sin mover o quitar ninguno de los elementos de la tapicería. Este sofá tiene rasgos del estilo vintage, como una referencia clara de los modelos en los que se inspira. Sofá totalmente desenfundable.

*The Spat sofa has an almost primary shape, as if was created from a ductile material with a gesture. Italian-style opening system: the passage from the sofa position to the bed position takes place without moving or removing any of the upholstery elements. This sofa has features of the vintage style, as a clear reference of the models in which it is inspired. Sofa with fully removable covers.*

Le canapé Spat a une forme presque primaire, comme s'il avait été créé d'un geste à partir d'un matériau ductile. Système d'ouverture à l'italienne: le passage de la position canapé à la position lit se fait sans déplacer ni enlever aucun des éléments de rembourrage. Ce canapé présente des caractéristiques du style vintage, comme une référence claire aux modèles dont il s'inspire. Canapé avec housses entièrement amovibles.

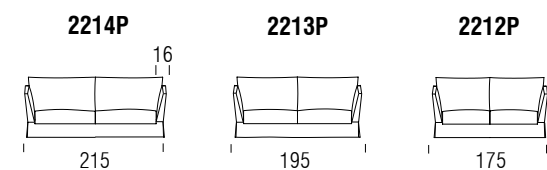
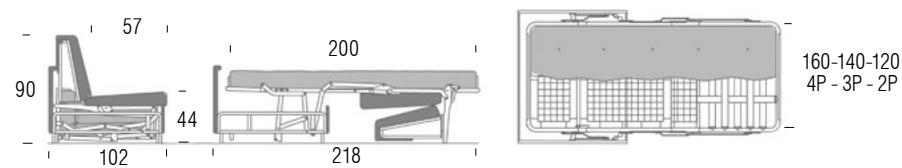



# True

Arbel

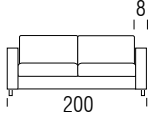
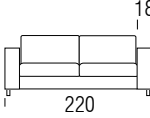
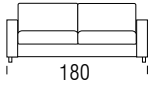
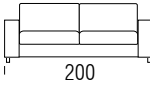
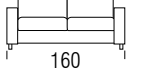
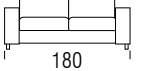

True, sofá cama de aspecto contemporáneo, ligero gracias a la altura de patas, pensado para todo tipo de espacios ya sea en el hogar o para espacios contract. Sistema de apertura tipo italiana. Mecanismo de movimiento con apertura frontal mediante rotación del respaldo en un único movimiento. El paso de la posición sofá a la posición cama tiene lugar sin mover o quitar ninguno de los elementos de la tapicería.

OP. A		OP. B	
	1184A		1184B
	1183A		1183B
	1182A		1182B

True



*True, contemporary sofa bed, lightweight in appearance thanks to the height of the legs. Designed for all types of spaces either at home or contract spaces. Italian opening system. Front opening mechanism by rotating the backrest with a single movement. We transform from the sofa into a bed without removing any upholstered part.*

*True, canapé lit d'aspect contemporain, d'apparence légère grâce à la hauteur des pieds, pensé pour tout type d'espaces, soit pour la maison, soit pour les espaces Contract. Système Italien d'ouverture. Mécanisme de mouvement avec ouverture frontale avec rotation du dossier dans un seul mouvement. Le passage de la position canapé à la position lit s'effectue sans déplacement ou suppression d'aucun des éléments.*

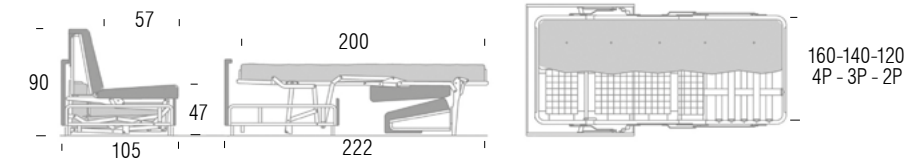



**TEGA** relax sofa. Dimensions CM (113x100 H86) + (113x100 H86).

**TAMO** armchair, black nickel finish frame. Dimensions CM 70x80 H80.

**GIB** side tables, black marble. Dimensions CM (120x70 H41.5) + (90x90 H36.5).

# Tega

Arbel

Módulos reclinables mediante mecanismo impulsado por motor eléctrico de extensión pared o lo convierten en un sofá perfecto para los usuarios más exigentes. El motor es accionado por una botonera oculta, ubicada en el lateral de cada uno de los asientos. El cabezal abatible manual proporciona la comodidad de un respaldo alto, por el apoyo completo de nuestra espalda.

*Reclining modules through a mechanism driven by electric motors of wall extension or make it a perfect sofa for the most demanding users. The motor is activated by a hidden button, placed on the side of each seat. The folding headrest provides the comfort of a high-back sofa, thanks to the full support of our back.*

*Des modules qui s'inclinent grâce à un mécanisme impulsé par un moteur électrique, il devient le canapé parfait pour les utilisateurs les plus exigeants. Le moteur est actionné par des boutons cachés, placés sur le côté de chacune des assises. La tête rabattable fournit le confort d'un dossier haut, par le soutien complet de notre dos.*



RELAX / RECLINER

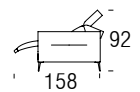

730M2



730ME



730M1



7302S



730ES



7301S



FIJO / FIX / FIXE

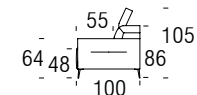

730F2



730FE



730F1



7302F



730EF



7301F



730CS

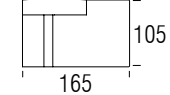



- .KLAS relax sofa. Dimensions CM (104x160 H105) + (80x95 H105) + (104x95 H105).
- .ONLY armchairs, oak finish legs. Dimensions CM 82x78 H110.
- .LAYA side table, white marble and walnut finish wood. Dimensions CM 120x70 H40.
- .HERA side table, ash finish wood. Dimensions CM Ø45 H70.

# Klas

Arbel



El sofa relax Klas es la respuesta que Belta Frajumar ofrece a todos aquellos que buscan una comodidad especial con la mayor calidad. Las formas envolventes de la pieza, el refuerzo en la zona lumbar y la suave apertura del mecanismo; lo convierten en un sofá perfecto para los usuarios más exigentes. Módulos reclinables mediante mecanismo impulsado por motor eléctrico de extensión pared o.

*The relax sofa Klas is the answer Frajumar offers to all those who seek a special comfort with the highest quality. Wraparound shapes, reinforcement in the lumbar area and the smooth opening of the mechanism make it a perfect sofa for the most demanding users. Reclining modules with mechanism driven by electric motors on the extension.*

Le canapé relax Klas est la réponse que Frajumar offre à tous ceux qui cherchent un confort spécial avec la meilleure qualité possible. Les formes qui embrassent la pièce, le renforcement de la zone lombaire et la douce ouverture du mécanisme, font de Klas le canapé parfait pour les personnes les plus exigeantes. Modules inclinables grâce au mécanisme impulsé par un moteur électrique d'extension.

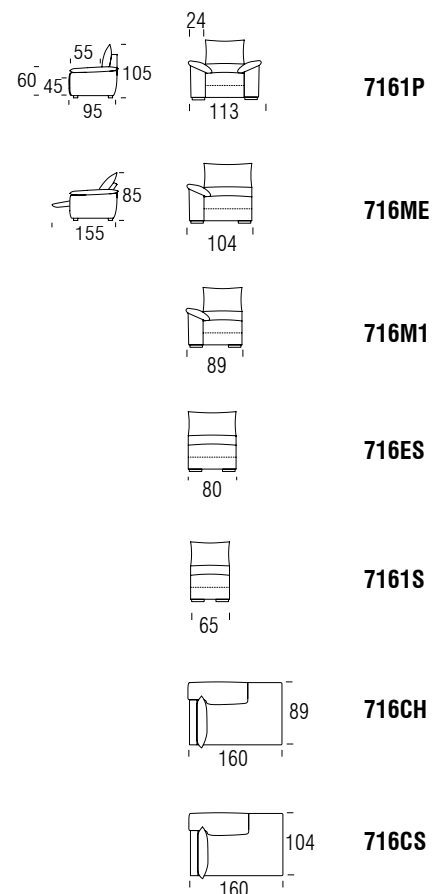

# Adex

Alejandro Azorín

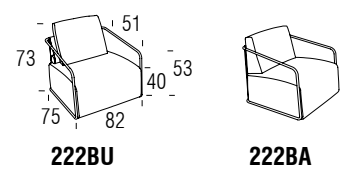

# Arbo

J. Miguel Andrés

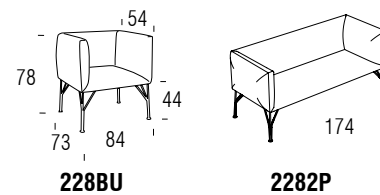

# Alma

Arbel

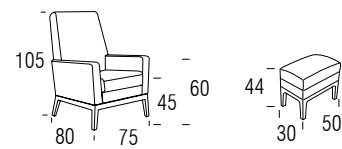

194BZ

194PF



# Apil

D. E. Gagliardini

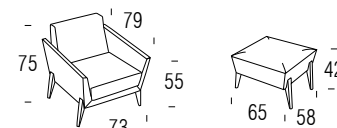

229BU

229PF



# Arko

D. E. Gagliardini

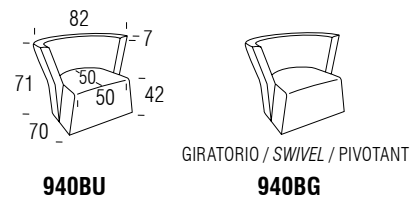

# Boss

Pablo Cano

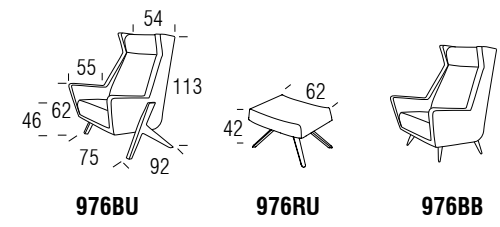



# Bazk

Arbel

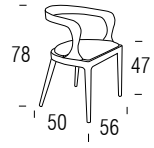

230SI



Bazk





# Blom

Alejandro Azorín

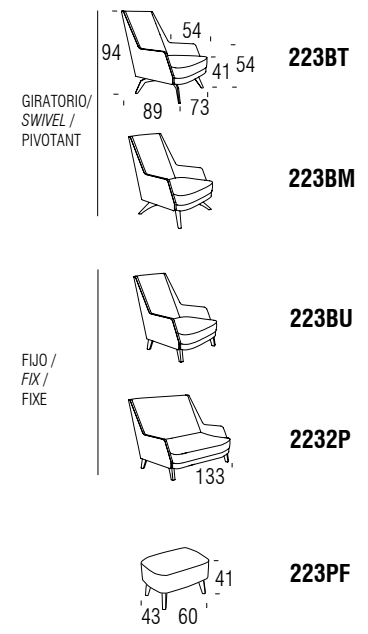

# Delp

D. E. Gagliardini

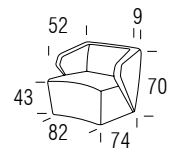

960BU



960BG

GIRATORIO /  
SWIVEL /  
PIVOTANT



# Erto

Robert Ortega

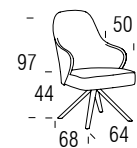

209BQ



209BC



# Delta

Javier Herrero

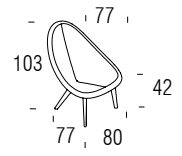

224BU



224BG

GIRATORIO Y RETORNABLE /  
 SWIVEL AND RETURNABLE /  
 PIVOTANT ET REMBOURSABLE

## Delta



# Diab

D. E. Gagliardini

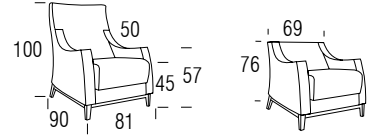

**231BA**

**231BU**



# Ecko

Arbel

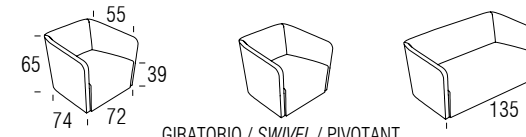

**225BU**

**225BG**

**2252P**

GIRATORIO / SWIVEL / PIVOTANT



# Egon

D. E. Gagliardini

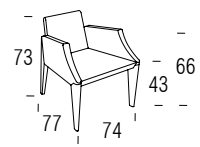

232BU



# Erik

D. E. Gagliardini

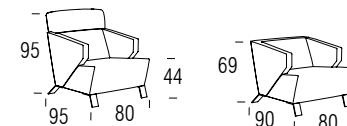

995BA

995BU



# Erne

Arbel

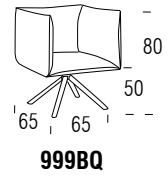

# Even

Robert Ortega

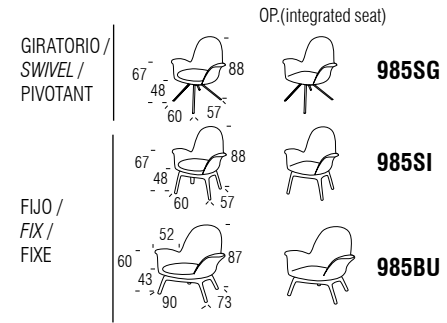



# Goia

Pablo Cano

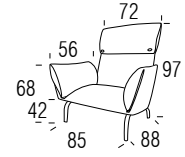

984BU

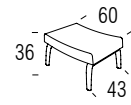

984RP



# Kida

D. E. Gagliardini

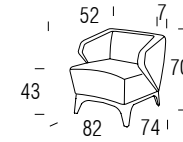

233BU



# Kora

D. E. Gagliardini

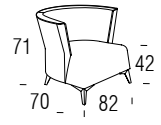

234BU



# Lase

Arbel

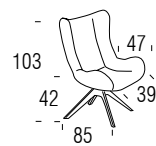

328BM



328BQ



328BC



# Marc

Jorge Pensi

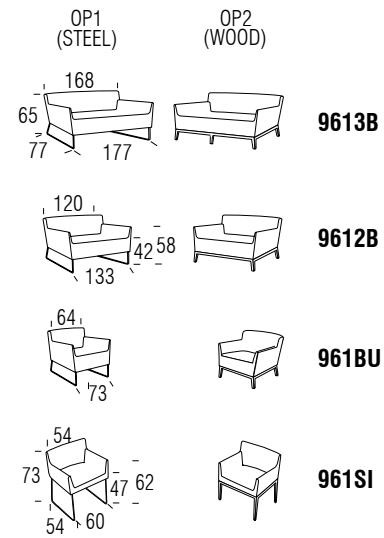

# Nies

Vicente Gallega

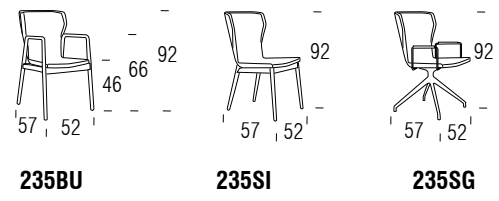

GIRATORIO /  
SWIVEL /  
PIVOTANT



# Muse

Arbel

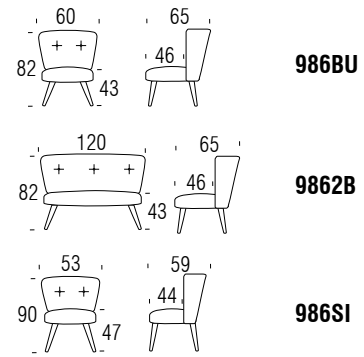

# Ofre

Eduardo Climent

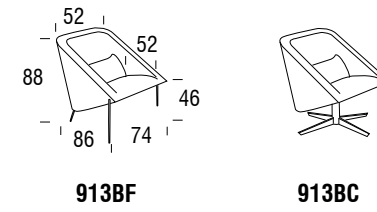

# Only

Robert Ortega

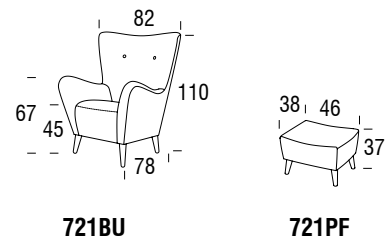

# Vera

Arbel

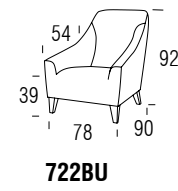

# Pao

Lluís Codina

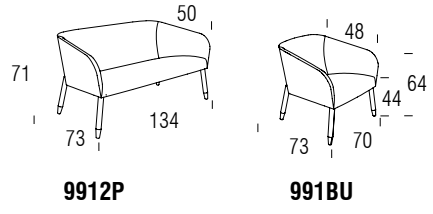

# Punk

Robert Ortega

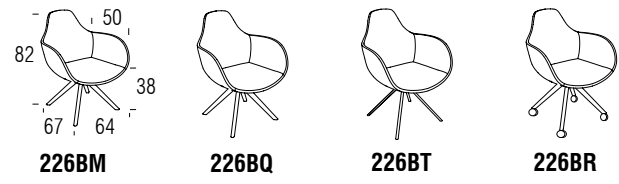

# Tery

Arbel

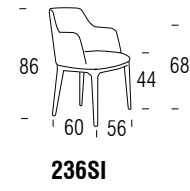



# Tamo

Vicente Gallega

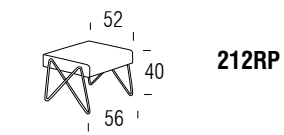
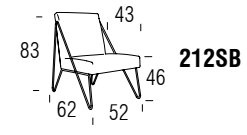
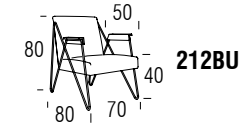
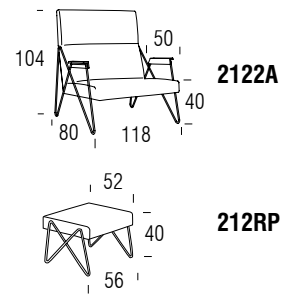
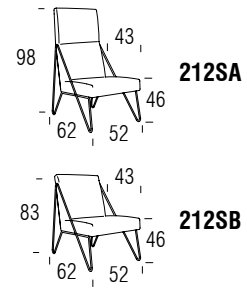
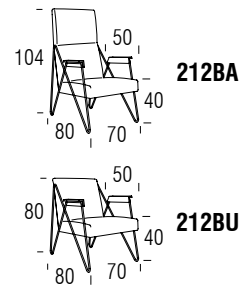

# Thin

Achodoso

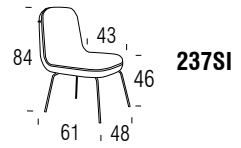

237SI

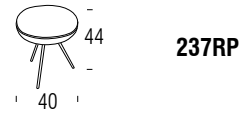

237RP



**Beltá Frajumar fabrica productos de larga duración que ayudan al uso responsable de los recursos naturales. Trabajando únicamente con madera de bosques gestionados para cumplir las necesidades sociales, económicas y ambientalmente responsables de generaciones futuras.**

*Beltá Frajumar manufactures durable products that support the responsible Use of Natural Resources. Working only with wood from forests that are managed to meet the social, economic and environmentally responsible needs of future generations.*

Beltá Frajumar fabrique des produits durables qui soutiennent l'utilisation responsable des ressources naturelles. En ne travaillant qu'avec du bois provenant de forêts gérées de manière à répondre aux besoins sociaux, économiques et environnementaux responsables des générations futures.



# Agol

D. E. Gagliardini

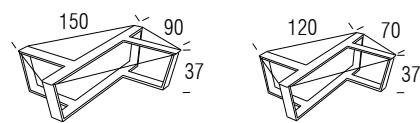

83116

83112



# Alo

Arbel

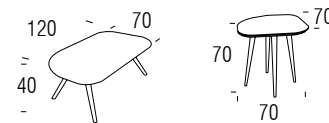

82318

82312





# Back

Robert Ortega

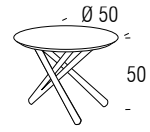

83250



# Even

Arbel

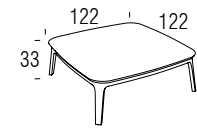

98512

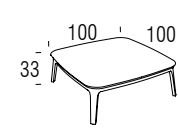

98510

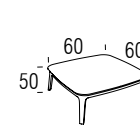

98560



# Domo

Vicente Gallega

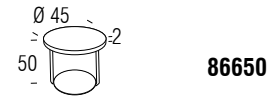
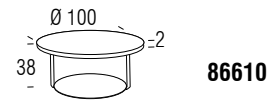

# Fres

Arbel

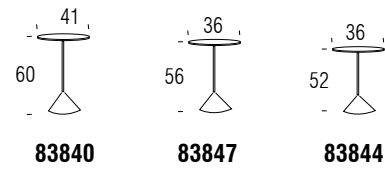

# Gib

Arbel

OP1	OP2	OP3		
0.6 [ 39.5 ]	3.5 [ 42.5 ]	2 [ 41.5 ]	120 [ 70 ]	<b>80670</b>
0.6 [ 39.5 ]	3.5 [ 42.5 ]	2 [ 41.5 ]	100 [ 100 ]	<b>80610</b>
0.6 [ 44.5 ]	3.5 [ 47.5 ]	2 [ 46.5 ]	60 [ 60 ]	<b>80660</b>
0.6 [ 34.5 ]	3.5 [ 37.5 ]	2 [ 36.5 ]	90 [ 90 ]	<b>80690</b>

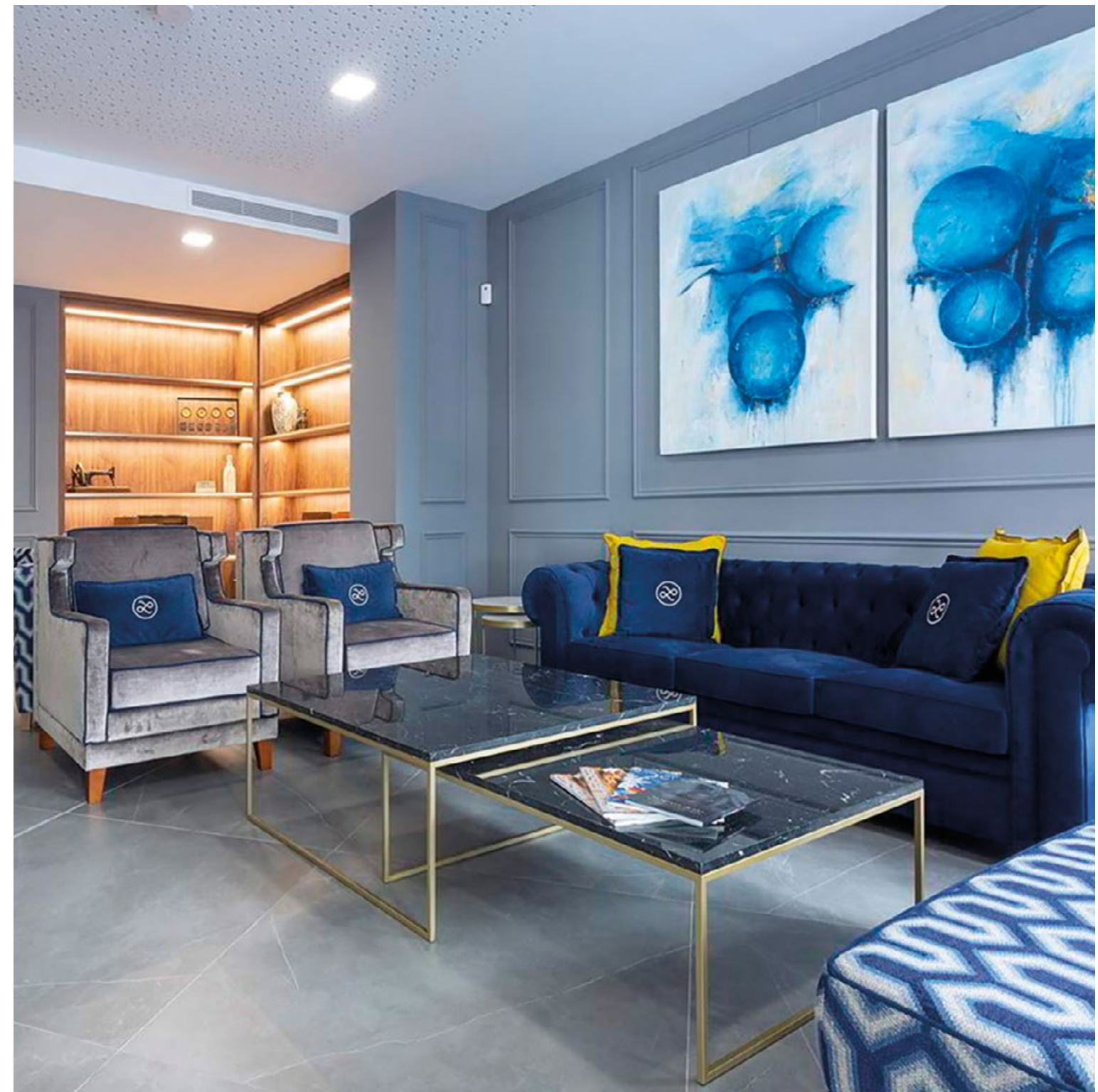

# Icon

Arbel

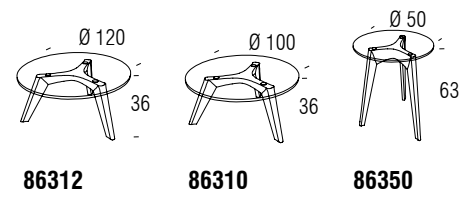

# Hera

Arbel

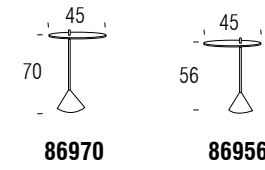



# Isen

Arbel

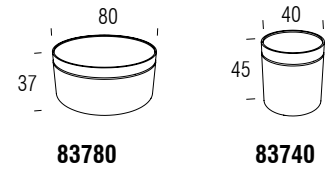

83780

83740



# Igno

Arbel

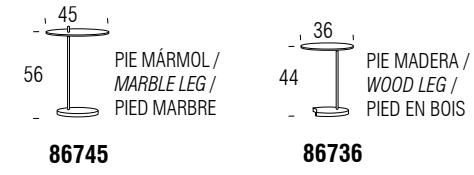

86745

86736





# Laya

Arbel

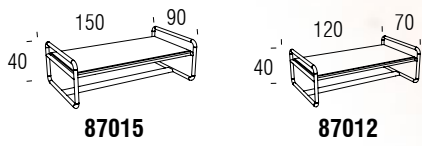

87015

87012



# Luna

Paolo Mauri - Ilmiodesign

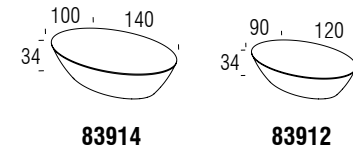

83914

83912



# Luxu

Arbel

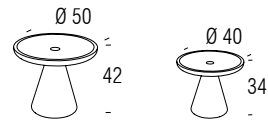

86850

86840



# Ólia

Vicente Gallega

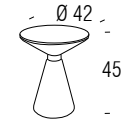

87145





# Open

Arbel

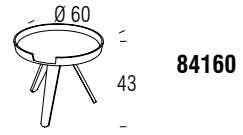

# Rund

Dsignio

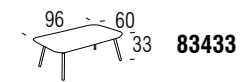
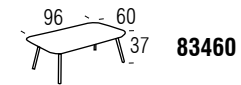
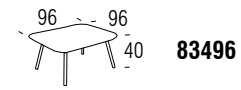
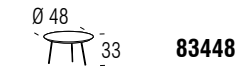
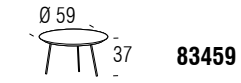

# Hang

Dsignio

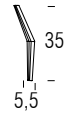

87535  
(2 UD)

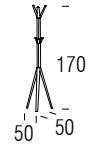

87517



# Gork

Arbel

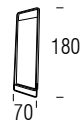

87420



# Opof

D. E. Gagiardini

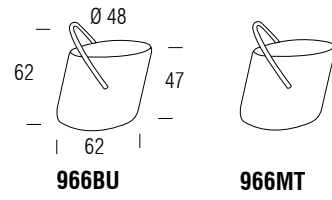

# Sedan

Paolo Mauri - Ilmiodesing

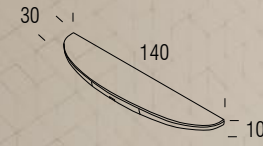

87814





# Skon

Arbel

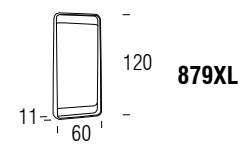

879XL

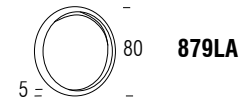

879LA

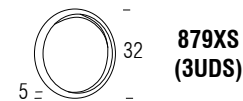

879XS  
(3UDS)





# Mars

Vicente Gallega

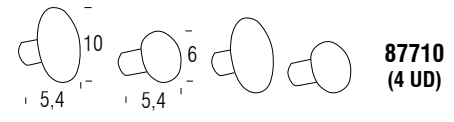

# Teo

Vicente Gallega

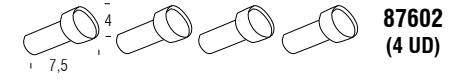
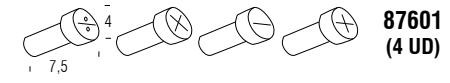



# Cube

Arbel



		<b>198PE</b>
Capitoné Quilted Capitone		<b>198PG</b>
		<b>198PC</b>
Liso Smooth Lisse		<b>198PA</b>
		<b>198PN</b>
		<b>198PF</b>
Costura Stitching Couture		<b>86510</b>
		<b>86550</b>
Suave Soft Moelleux		<b>97310</b>
		<b>97370</b>



# Pent

Dsignio

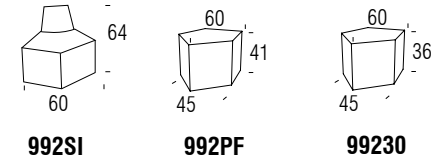

# Besk

Dsignio

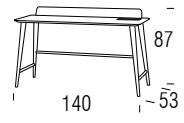

87314





# Poet

Lluís Codina

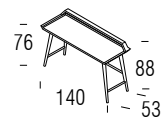

86414





# Spin

Arbel

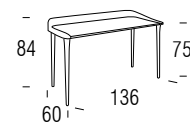

88036



# Sostenibilidad / Sustainability / Durabilité

La compañía, a partir de la aprobación de una **Política de Gestión Ambiental**, trabaja con empresas textiles, como Crevin, que convierten los residuos textiles en nuevos tejidos dándoles una segunda vida y minimizando la generación de desperdicios.

*The company, following the approval of an **Environmental Management Policy**, works with textile companies, such as Crevin, which convert textile waste into new fabrics, giving them a second life and minimising the production of waste.*

La société, après l'approbation d'une **Politique de Gestion Environnementale**, travaille avec des entreprises textiles, telles que Crevin, qui transforment les déchets textiles en nouveaux tissus, leur donnant ainsi une seconde vie et minimisant la production de déchets.

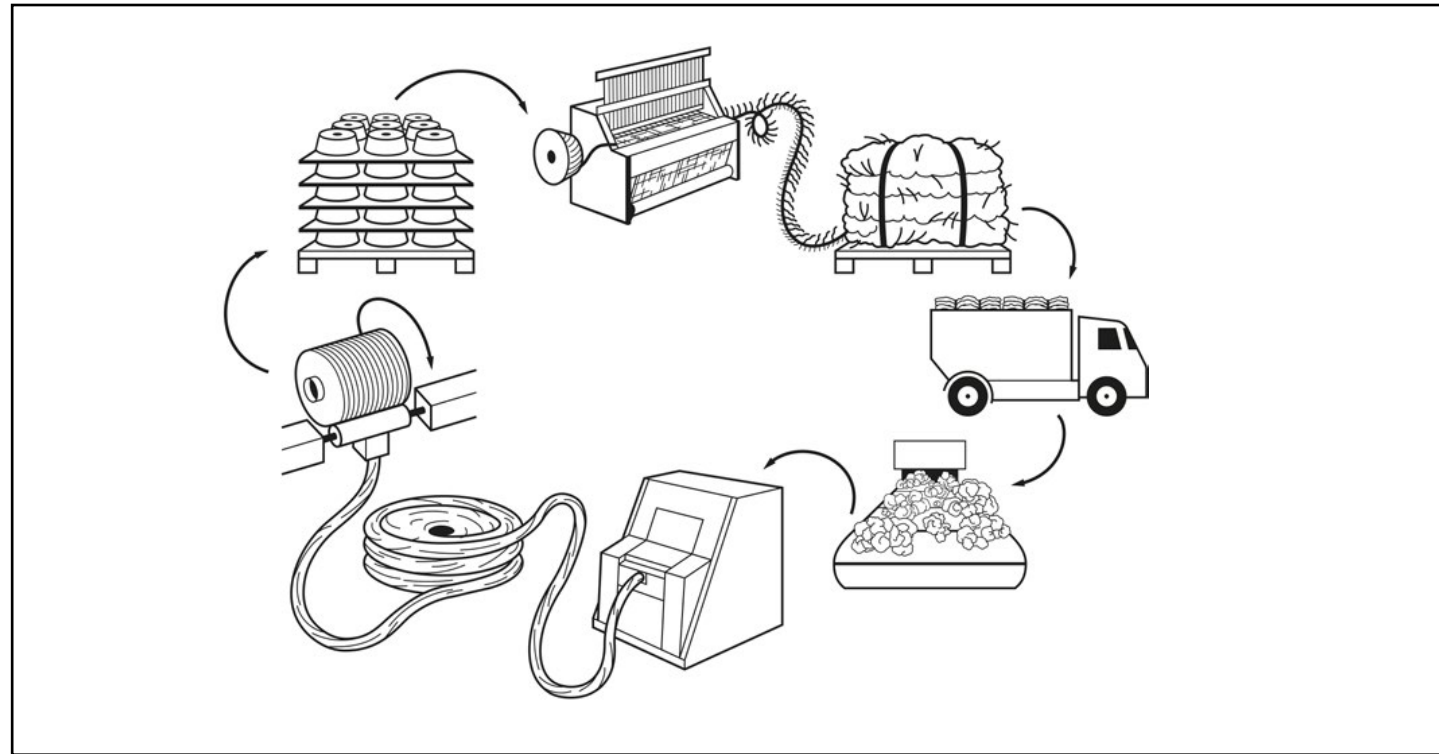

# Tejidos / Fabrics / Tissus

Beltá Frajumar trabaja con las principales firmas de tejidos de hogar e instalaciones. Algunas de las más habituales se las detallamos a continuación, si desea trabajar con un tejido de una firma diferente, consúltenos y se lo facilitaremos.

*Beltá Frajumar work with the main fabric manufacturers for both home and contract. Some of the best known are indicated below. Should you want fabrics from another manufacturer, please consult us, and we will obtain it.*

Beltá Frajumar travaille avec les principaux fournisseurs de tissus domestiques et projets contract. A titre d'exemple, nous vous détaillons certain des plus habituels. Si vous désirez travailler avec un tissu d'un fournisseur différent, merci de nous consulter et nous vous informerons si cela possible.

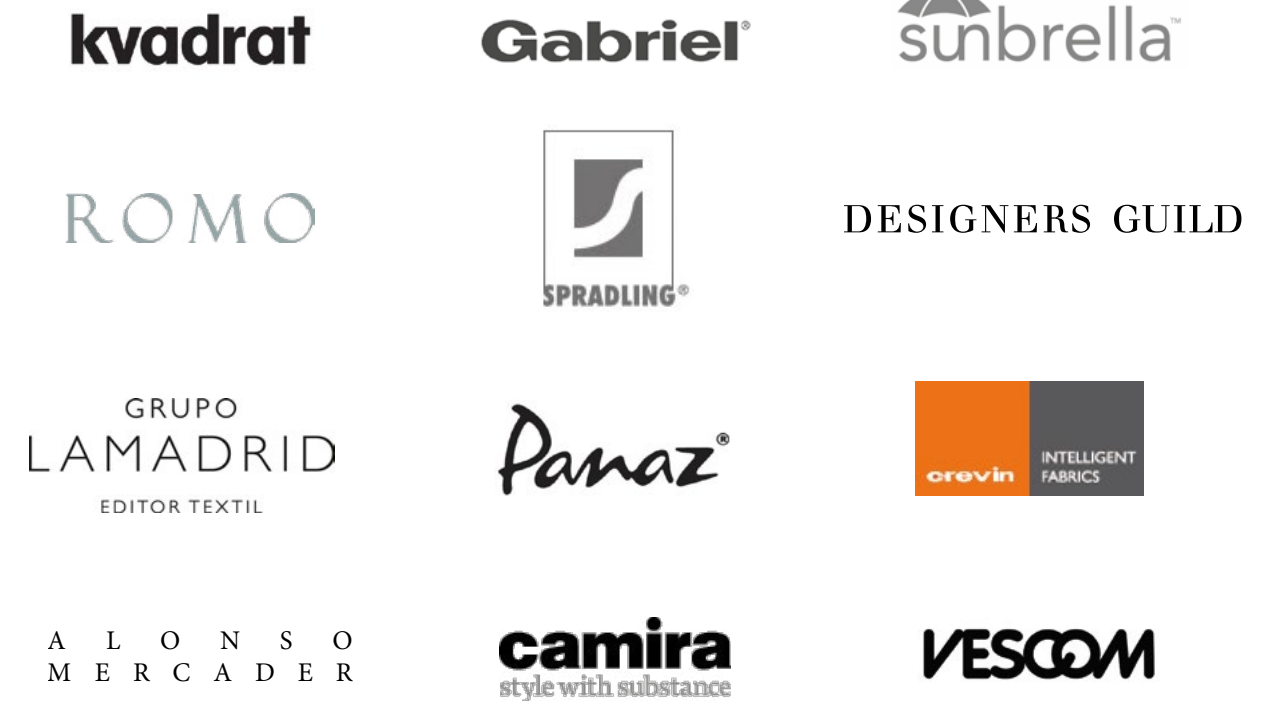

# Color del hilo / Thread color / Couleur du fil

	<b>RAL 9010</b> Blanco White Blanc		<b>RAL 9016</b> Blanco tráfico White traffic Blanc trafic		<b>RAL 9018</b> Gris papiro Papyrus grey Gris papyrus		<b>RAL 9022</b> Gris perlado Pearl grey Gris perle
	<b>RAL 9023</b> Gris oscuro Dark grey Gris foncé		<b>RAL 5022</b> Azul noche Midnight blue Bleu nuit		<b>RAL 5017</b> Azul tráfico Blue traffic Bleu trafic		<b>RAL 5023</b> Azul lejania Far blue Bleu lointain
	<b>RAL 5018</b> Azul turquesa Turquoise blue Bleu turquoise		<b>RAL 6002</b> Verde hoja Green leaf Vert feuille		<b>RAL 6018</b> Verde amarillento Yellowish green Vert jaunâtre		<b>RAL 1013</b> Blanco perla Pearl white Blanc perle
	<b>RAL 1001</b> Beige Beige Beige		<b>RAL 1019</b> Beige agrisado Greyish beige Beige grisâtre		<b>RAL 1011</b> Beige pardo Brownish beige Beige brunâtre		<b>RAL 1021</b> Amarillo colza Rape yellow Jaune de viol
	<b>RAL 1037</b> Amarillo sol Sunshine yellow Jaune soleil		<b>RAL 2003</b> Naranja pálido Pale orange Orange pâle		<b>RAL 3000</b> Rojo vivo Bright red Rouge vif		<b>RAL 3011</b> Rojo pardo Brownish red Rouge brunâtre
	<b>RAL 3015</b> Rosa claro Light pink Rose clair		<b>RAL 8001</b> Pardo ocre Ochre brown Brun ocre		<b>RAL 8017</b> Chocolate Chocolate Chocolat		<b>RAL 9005</b> Negro Black Noir

PROVEEDOR SUPPLIER FOURNISSEUR	COLECCIÓN SERIE COLLECTION SERIE	PROVEEDOR SUPPLIER FOURNISSEUR	COLECCIÓN SERIE COLLECTION SERIE	PROVEEDOR SUPPLIER FOURNISSEUR	COLECCIÓN SERIE COLLECTION SERIE
TELAS / FABRICS / TISSUS					
DESIGNERS GUILD	BRERA LINO S-5 GLENVILLE S-5 RIVEAU S-5 ZARAGOZA S-4 EASTON S-3 ROTHESAY S-4 HETTON S-3 KINTORE S-3 AUSKERRY S-3	KVADRAT	REVIVE 1/2 S-9 FIELD S-9 MESSENGER 5 S-6 PRO 3 S-9	MARIANO FARRUGIA	SAVANA DALMATA ANTIQ COLONIAL DALI
CREVIN	VELVETY S-3 NOAH S-3 ONIX S-3 DROM S-3 SUBLIM S-3 MATISS S-4 TWIN S-3 LIBRA S-3 CREDO S-3 ITO S-3 CHIC S-3 SONNET S-2 ERBA S-3 CHANEL S-3	VESCOM	BOWEN S-9 SAMAR S-7 LOMBOK S-8 LANI S-9 PONZA S-8	SPRADLING	VALENCIA S-2 SILVERTEX S-3 VOGUE S-3 MAGLIA S-3 HITCH S-4 DIAMANTE S-4 ZANDER S-3
FROCA	HARRIER S-1 LIDO S-0 ARMANI S-0 BALENCIAGA S-1 PRAGA S-2 VARADERO S-2 INDIGO S-1 CHANNEL S-1 DAKOTA S-2	GÜELL LAMADRID LE - CREATIONS	DURY S-3 GENT S-5 LECH S-5 TEO S-4	ALONSO MERCADER	STAR S-3 ACUA S-2 GRAIN S-2 RX S-2 FLOR S-2 MAXIUM S-3 FILTECH S-2
		SUNBRELLA	NATTÉ S-3 DEAUVILLE S-5 LOPI S-6 MEZZO S-4 SOLIDS S-4	ELASTRON	QUEENS S-0 PARIS S-1 BOSTON S-1 DUBAI S-0
		VISUAL	MYSTIC S-2 OTARU S-2 HARUKA S-2 MINERVA S-2 AMARAL S-2 INVICTUS S-2 BELLAGIO S-3 CAPRICCIO S-3		
		TEXTIL ROIG	DESERT S-3 TERRA S-2 A0007 S-4		

■ Los colores de los tejidos y polipieles pueden variar de una partida a otra.  
■ Colours of fabrics and Eco Leather may vary from different lot productions.  
■ Les couleurs des tissus et similicuir peuvent être différents d'un métrage à un autre.

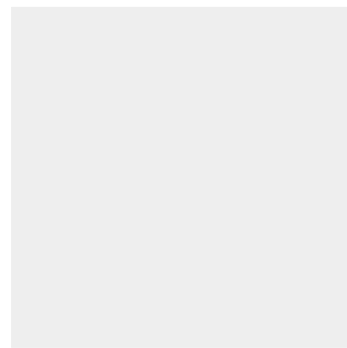
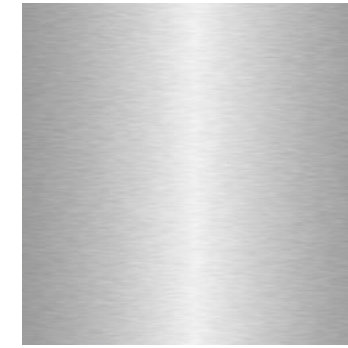
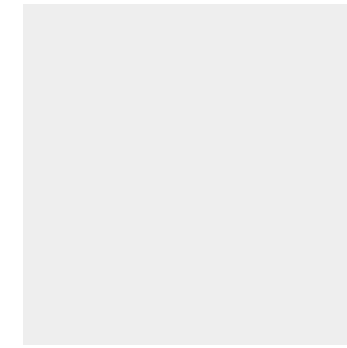
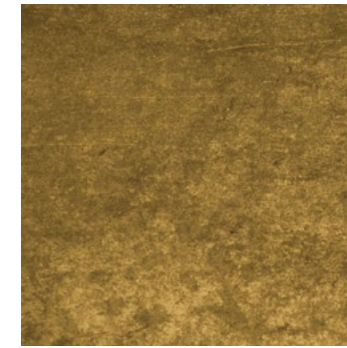
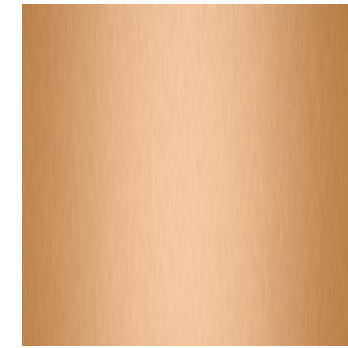
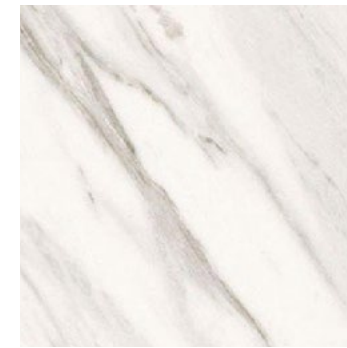
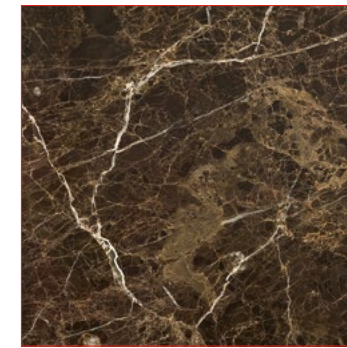
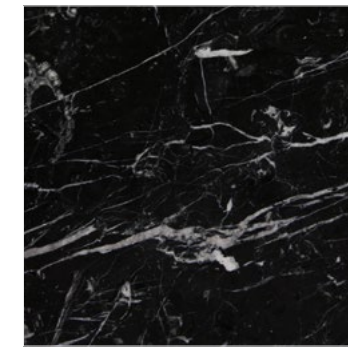
**MADERA** / WOOD / BOIS**Roble** / Oak / Chêne**Nogal** / Walnut / Noyer**Fresno** / Ash / Frêne**Haya** / Beech / Hêtre**Sicomoro** / Sycamore / Sycomore**Cerezo** / Cherry / Merisier**Iroko****Wengue****LACADO** / PAINTED / PEINTURE**Piedra** / Stone / Pierre  
RAL 9002**Gris** / Grey  
RAL 7042**Mar** / Sea / Mer  
RAL 6033**Grafito** / Graphite  
RAL 7021**Fucsia** / Fuchsia  
RAL 4008**Verde** / Green / Vert  
RAL 1016**Blanco** / White / Blanc  
RAL 9016**Negro** / Black / Noir  
RAL 9005**METAL** / METAL / MÉTAL**Acero Inox** / Stainless Steel / Acier Inox**Cromado** / Chromed / Chromé**Aluminio** / Aluminum / Aluminium**Blanco** / White / Blanc**Níquel Oscuro** / Dark Nickel / Nickel Foncé**Oro viejo** / Old Gold / Or vieil**Cobre** / Copper / Cuivre**Negro** / Black / Noir**CRISTAL** / GLASS / VERRE**Transparente** / Transparent**Blanco** / White / Blanc**Chocolate** / Chocolat**Negro** / Black / Noir**MÁRMOL** / MARBLE / MARBRE**Blanco** / White / Blanc**Marrón Imperial** / Brown / Brun**Negro** / Black / Noir





# INTERCIDEC AWARDS

CONCURSO INTERNACIONAL DE DISEÑO DE ENTORNOS CONTRACT



**6th**  
EDITION  
**2021**

El objetivo de **InterCIDEC** es conectar a los mejores arquitectos, diseñadores de interior y hoteleros de todo el mundo. Estos premios es la expresión de nuestro compromiso con el diseño, nos acerca a los profesionales en los que confiamos, a proyectos en los que creemos y a las personas con quienes queremos compartirlos. Creemos que es una gran oportunidad de generar sinergias entre dichos profesionales del sector.

*The goal of **InterCIDEC** is to connect the best architects, interior designers and hoteliers from around the world. These awards are the expression of our commitment to design, it brings us closer to professionals we trust, projects we believe in and the people with whom we want to share them. We believe that it is a great opportunity to generate synergies between these professionals in the sector.*

L'objectif d'**InterCIDEC** est de connecter aux meilleurs architectes, décorateurs d'intérieur et hôteliers du monde entier. Ces prix sont l'expression de notre engagement avec le design, nous rapprochant des professionnels auxquels nous faisons confiance, des projets auxquels nous croyons et des personnes avec lesquelles nous voulons les partager. Nous pensons que c'est une grande opportunité de générer des synergies entre ces professionnels du secteur.



## 2020

Marca Rahola.  
Javier Fernández.  
Jérôme Gateau.  
M<sup>a</sup> José Gómez  
Francisco Pérez.  
M<sup>a</sup> Luisa Ruiz de Velasco.  
David García  
Vicente Gallega  
José Antonio Alonso.  
Marta Palao.



## 2019

Ághata Ruiz de la Prada.  
Andrea Spada.  
Eva Muñoz.  
Damián Pujol.  
Loli Moróño.  
Pepe Cosín.  
Ricardo Vallejo.  
Carlos Beamonte.  
Cary Rodríguez.  
David Puerta.  
Cesáreo Martín.  
Robert Ortega.



## 2018

Pepe Seguí.  
Diego Gronda.  
Rafa Fraile.  
Mónica Fullana.  
Marta Farré.  
Pepe Costa.  
M<sup>a</sup> Carmen Ayala.  
Arannta Santamaria.  
José Francisco Puche.  
Margarita Escribano.  
Jesús Torné.  
M<sup>a</sup> Isabel Pérez.  
Carlos Juan Ortiz.



## 2017

José Manuel Fernández.  
Juan Carlos Rodríguez.  
Carlos Díez de la Lastra.  
Esteban Rodríguez.  
Teresa Casas.  
Joaquín Gómez.  
Rosa Sánchez.  
Antonio Serrano.  
Ángel Benigno.  
Jorge Juan Ortiz.



## 2016

Teresa Sapey.  
Jorge Pensi.  
Dario Gagliardini.  
Luis Sendra.  
Miguel Sánchez.  
Paolo Mauri.  
Ángel Rocamora.  
Dan Ohayon.  
Francisco L. Juan.

**Gracias a todos los profesionales que han hecho realidad este proyecto. Sin vosotros esto no sería posible.**

Impreso: Marzo 2021  
Copyright © Belta Frajumar 2021  
Reservados todos los derechos

Frajumar S.L. se reserva el derecho de cambiar, en cualquier momento y sin previo aviso, las especificaciones técnicas de cualquier producto ilustrado en este catálogo.

Para más información, visite nuestro sitio web.

***Thanks to all the professionals that made this project a reality. Without you, it wouldn't have been possible.***

*Printed: Marzo 2021  
Copyright © Belta Frajumar 2021  
All rights reserved*

*Frajumar S.L. reserves the right to change, at any time and without prior warning, the technical specifications of any product illustrated in this catalogue.*

For further information visit our website.

**Merci à tous les professionnels qui ont fait de ce projet une réalité. Sans vous, nous ne pourrions pas exister.**

Imprimé: Marzo 2021  
Copyright © Belta Frajumar 2021  
Tous les droits sont réservés

Frajumar S.L. se réserve le droit de modifier, à tout moment et sans avertissement préalable, les spécifications techniques de tout produit illustré dans ce catalogue.

Pour plus d'informations, visiter notre site web.



**[www.beltafrajumar.com](http://www.beltafrajumar.com)**



# BeltáFrajumar

FURNITURE AND UPHOLSTERY MANUFACTURER SINCE 1967



© Poeta Francisco Antonio Jiménez, 33  
30510 Yecla (Murcia) SPAIN.

☎ T +34 968 719 111  
F +34 968 753 690

✉ info@beltafrajumar.com  
[www.beltafrajumar.com](http://www.beltafrajumar.com)

