

Bōln

#BOLNSYSTEM

we
are
working
on
a
softer
world

[BOLN.EU](https://boln.eu)

welcome
outside



welcome outside

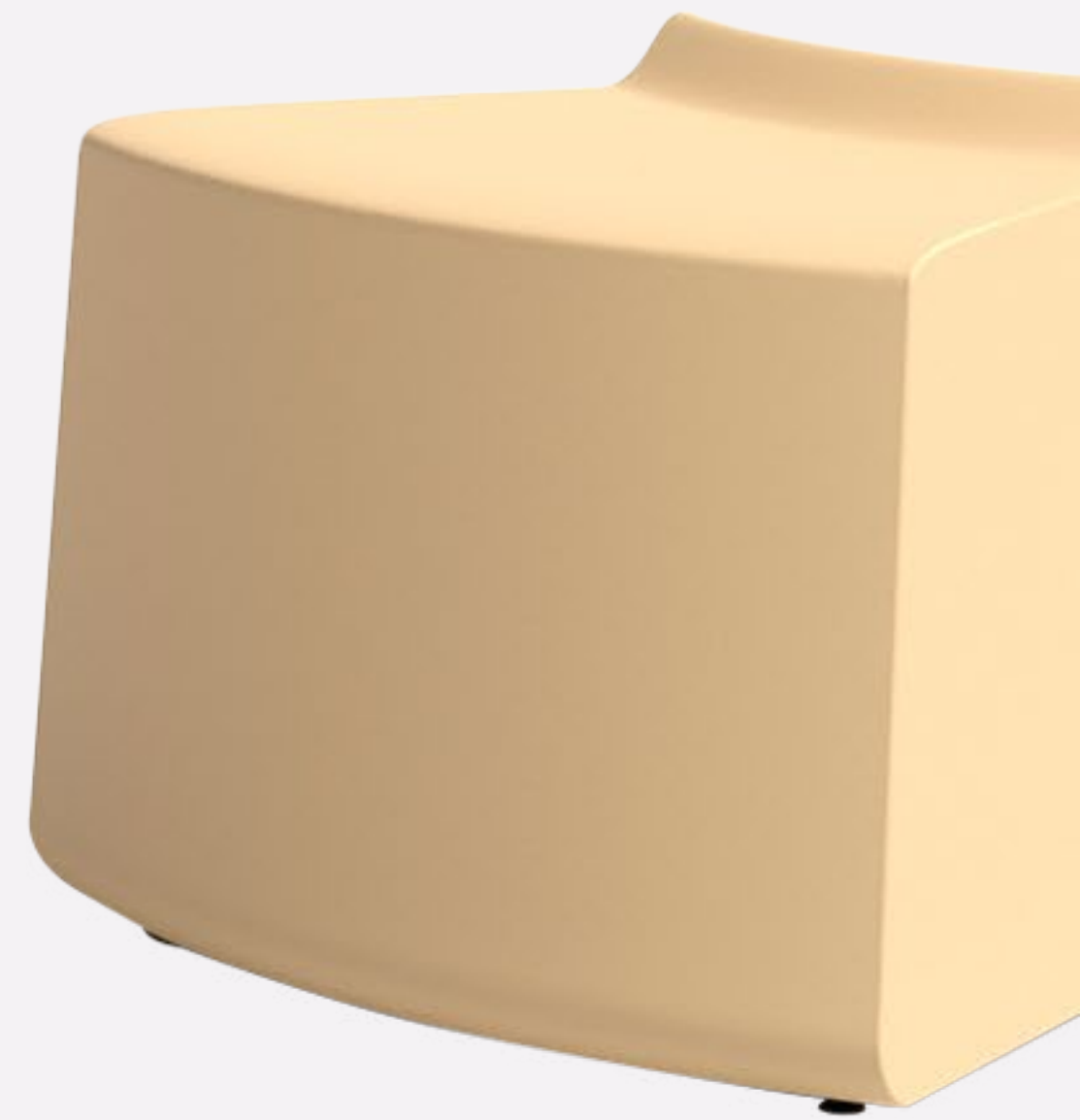

**Innovative and creative
designs for contract spaces
Versatile, long-lasting,
eco-friendly and with
antibacterial properties.**

DISCOVER BÖLN

OUR DNA

CONTRACT FURNITURE INNOVATION THROUGH ITS DESIGN AND QUALITIES

Specially made for shared spaces, the Bōln collections have been carefully designed to create all sorts of environments. It is astonishing how many different styles and settings you can create with its unique and suggestive design: from fun, informal spaces to serious, architectural environments.

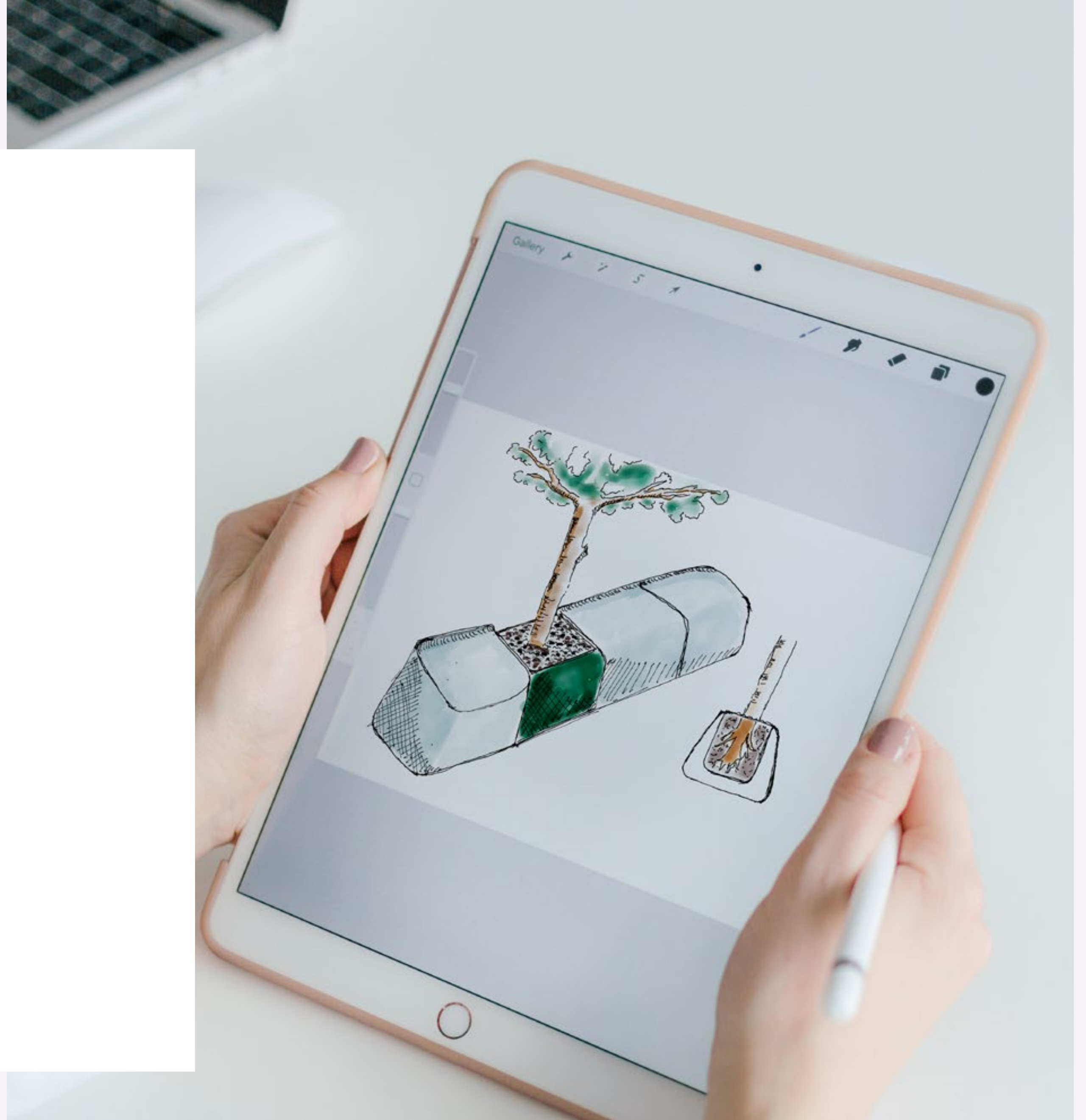

Bōln collections have been created to inspire and stimulate the creative design of shared spaces.

Versatile proposals with multiple options for different arrangements and a great performance, produced under eco-friendly and health standards.





01

VERSATILE DESIGN

For neutral, colorful, static or changeable environments... the Bōln collections have been designed to blend smoothly into a wide range of settings and styles.



02

HARD AND SOFT TEXTURE

This may seem contradictory, but it's not. The robust and compact material used for Bōln designs is in fact soft, pliable and comfortable.



03

CUSTOMIZABLE COLLECTIONS

They can be made in specific shades on demand. And with their accessories, you can create flexible and functional projects with stylish details.



04

RESILIENT AND LONG-LASTING

Bõln designs are made with **Flexyskin**, our own technology based on polyurethane foam for outdoor furniture that will withstand heavy use.

05

FOR INSIDE AND OUTSIDE

Given their properties, Bōln products are highly efficient outdoors. But they have been designed to also fit indoors.

06

INFINITE SETTINGS

For communal residential areas, hotels or shopping malls, offices, airports, sports centers, stores, waiting rooms and restaurants.



07

NATURAL AND SUSTAINABLE

The material used to make the Bōln collections comes from green waste. Our unique Flexyskin method, developed to manufacture the furniture, cuts down the amount of material used by up to 70% compared to other similar processes.

Power consumption is also lower as the molds allow us to produce it at a low temperature. Polyurethane foam is a recyclable and light material that leaves a smaller carbon footprint.

08

EASY TO CLEAN AND SAFE

One of the most desirable features of furniture in shared spaces is that it can be cleaned regularly, but this has become even more important since the outbreak of the Covid-19 pandemic.

Bōln is already living up to this demand. The seamless, fluid and organic design of our collections makes it easier to clean them regularly. Also, the furniture surfaces have antifungal and antibacterial properties certified by the JIS Z 2801 (ISO 22196) standard.

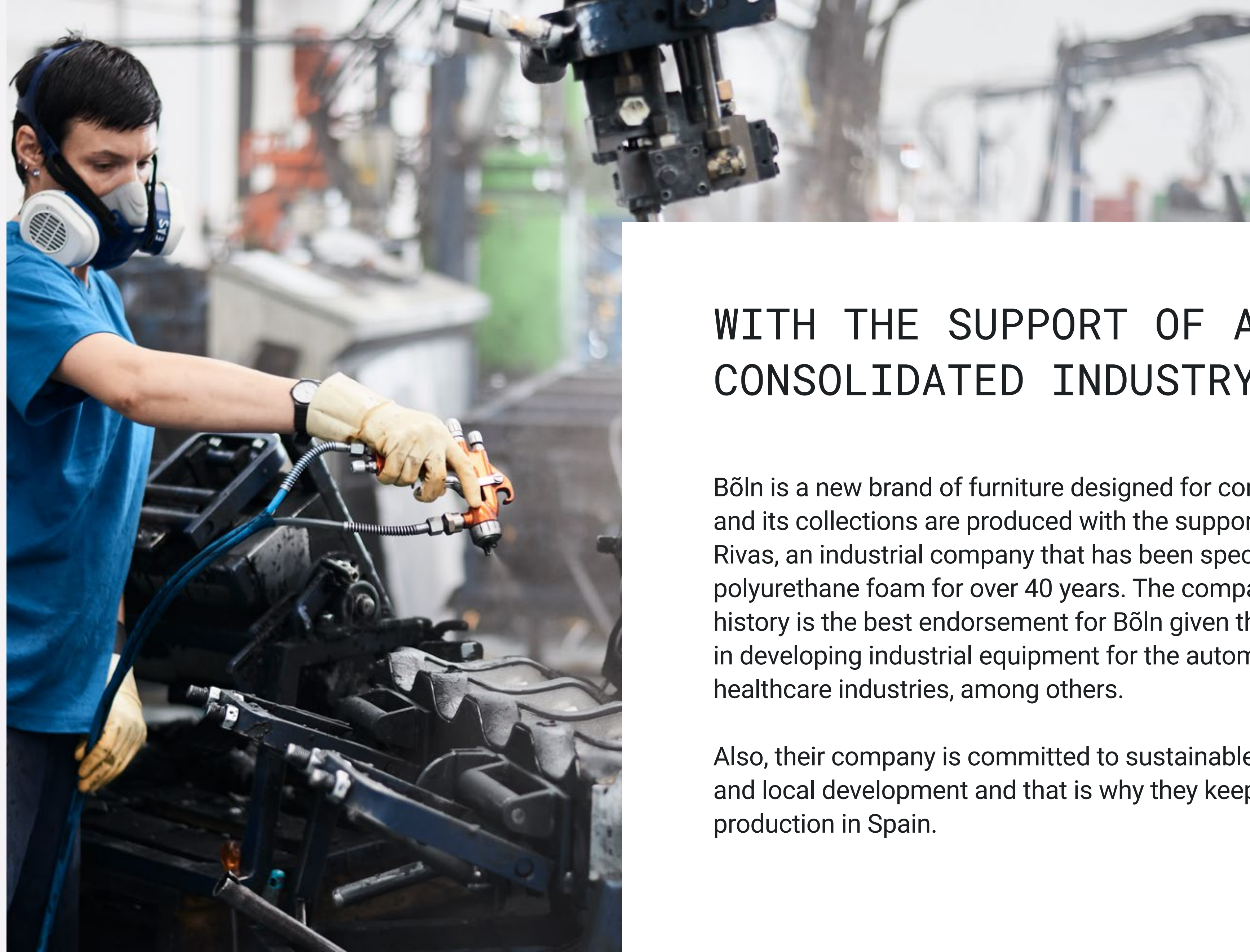

WITH THE SUPPORT OF A CONSOLIDATED INDUSTRY

Bõln is a new brand of furniture designed for contract spaces and its collections are produced with the support of Poliuretanos Rivas, an industrial company that has been specializing in injected polyurethane foam for over 40 years. The company's strong history is the best endorsement for Bõln given their experience in developing industrial equipment for the automotive, hotel and healthcare industries, among others.

Also, their company is committed to sustainable, eco-friendly and local development and that is why they keep all their production in Spain.

Bōln

SAREK

— SEATS



BOLN.EU

welcome
outside

**Organic designs to plan
fluid and changeable
environments.**

The look of Bōln's Sarek collection is doubly fluid and organic, which means that the design of its modules is curved with soft shapes, and the same goes for the arrangements with the modules.

SAREK

BOLN . EU



welcome
outside

Creativity with five modules

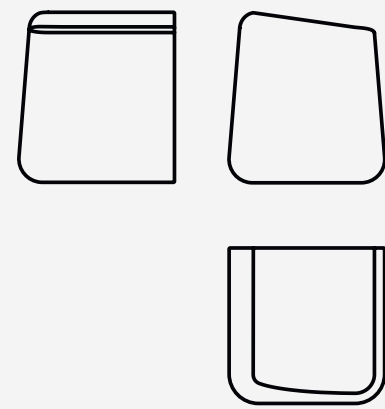

Sarek R

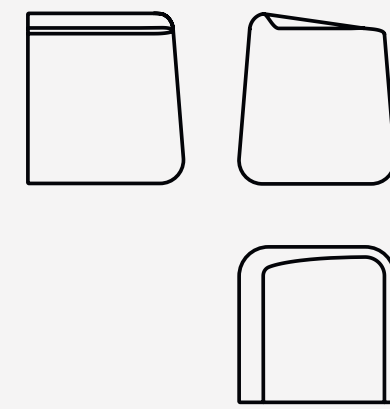

Sarek L

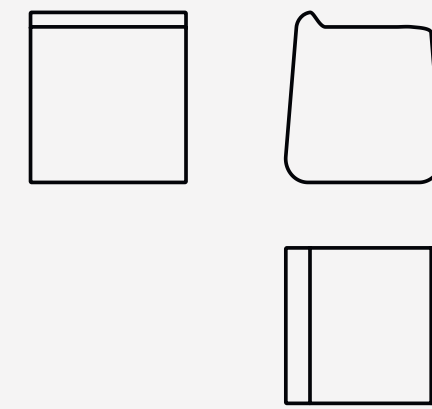

Sarek C

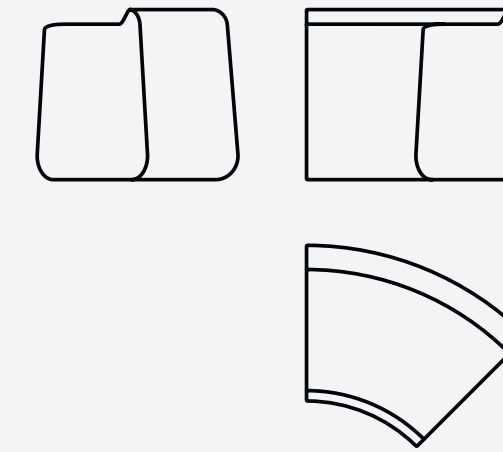

Sarek I

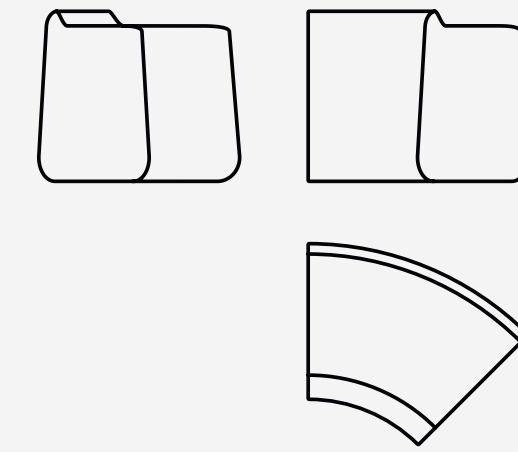

Sarek E

Environments with character

The shades available for the Sarek collection allow us to use color to design creative, customized spaces that will adapt to all architectural styles. For corporate environments, you can customize the shades on demand.

METAL LACQUERED

1004	1015	1027	2012	3000	3005	5020
6003	6007	6026	6033	7006	7034	9011

Tests

STUDY	NORM	RESULT
Metal migration	EN 71-3:2019	Check
Durability	UNE-EN 16139:2013 vc 2015	L1
Waterproof	UNE-EN ISO 811	> 2000 (cm/H2O)
Resistance to chemical agents and stains	UNE-EN 12720	Check
Artificial ageing (1000 h.)	UNE-EN ISO 4892-2	Slight change in brightness and colour according RAL
Fire	UNE -EN 1021:15 , UNE-EN 1021-2:15	Check
	BS 5852:06 crib 5	Check
Antibacterial	JIS Z 2801 (ISO 22196)	Check

Designers

Stone Designs is a cross-disciplinary design studio. It is based in Madrid but works worldwide on projects for interior design or products. This studio attended a special course on Flexyskin before working with Bōln on the design of the Sarek collection. A versatile modular system created with their own experience in designing interiors and heavy-duty shared spaces.

STONE-DSGNS.COM



Bōln

SAREK

— ACCESSORIES



BOLN.EU

welcome
outside

Functional spaces

The range of Sarek accessories allows us to create settings of all types with panels, side tables or meeting tables or even workstations. Also, modules can integrate power outlets connected to technical floors.



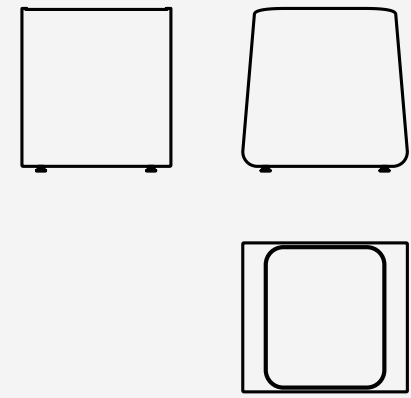

**Sarek
Plantpot**

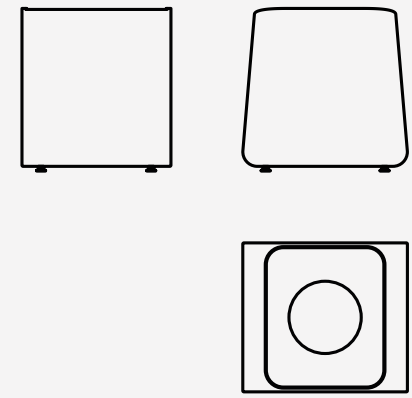

**Sarek
Basket 1**

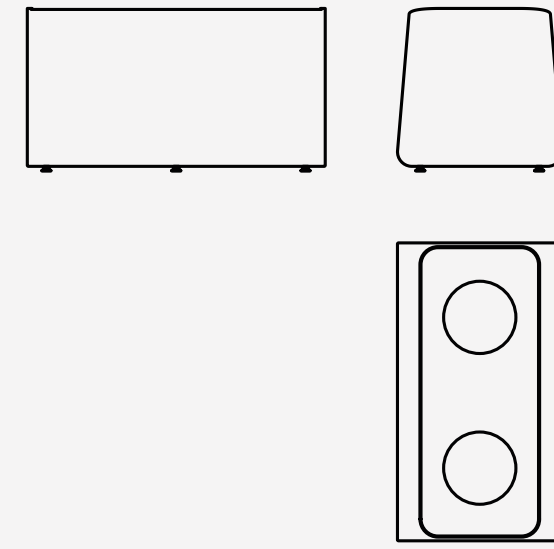

**Sarek
Basket 2**

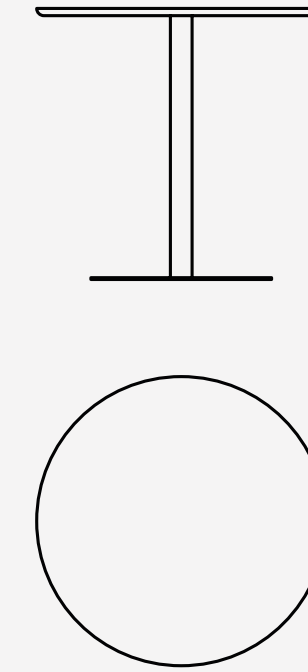

**Sarek
Round Table**

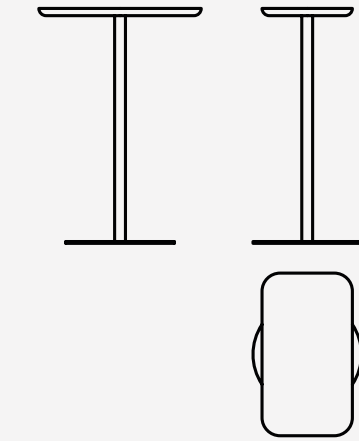

**Sarek
Side table**

Environments with character

The shades available for the Sarek collection allow us to use color to design creative, customized spaces that will adapt to all architectural styles. For corporate environments, you can customize the shades on demand.

Mobile and fixed arrangements

In environments that require flexibility, the weight of the modules is perfect to re-arrange them or to always keep the modules in the same place. Permanent structures used in shared spaces can be fixed with a clip.

METAL LACQUERED



MELAMINE BASKET (FINSA DUO RANGE)

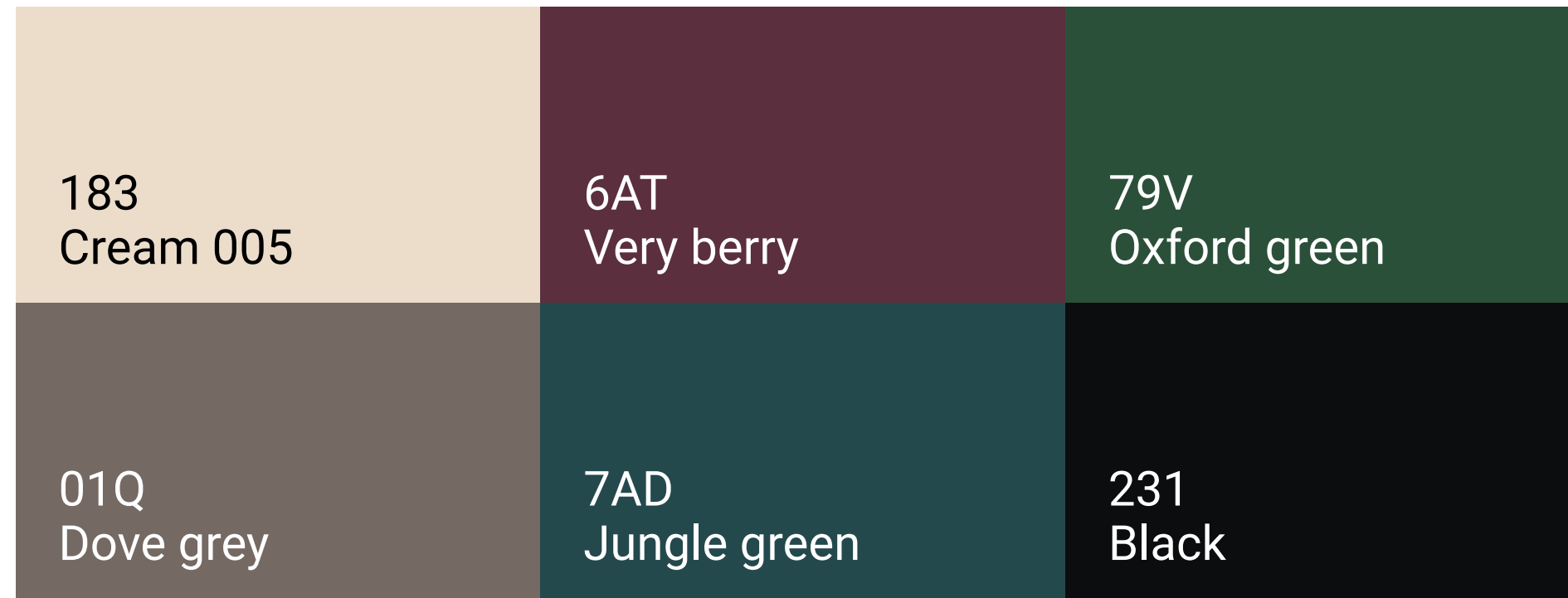

BOARDS



Designers

Stone Designs is a cross-disciplinary design studio. It is based in Madrid but works worldwide on projects for interior design or products. This studio attended a special course on Flexyskin before working with Bōln on the design of the Sarek collection. A versatile modular system created with their own experience in designing interiors and heavy-duty shared spaces.

STONE-DSGNS.COM



Böln

SAREK

— DIVIDERS



BOLN.EU

welcome
outside

Functional spaces

The range of Sarek accessories allows us to create settings of all types with panels, side tables or meeting tables or even workstations. Also, modules can integrate power outlets connected to technical floors.

SAREK

BOLN.EU

welcome
outside



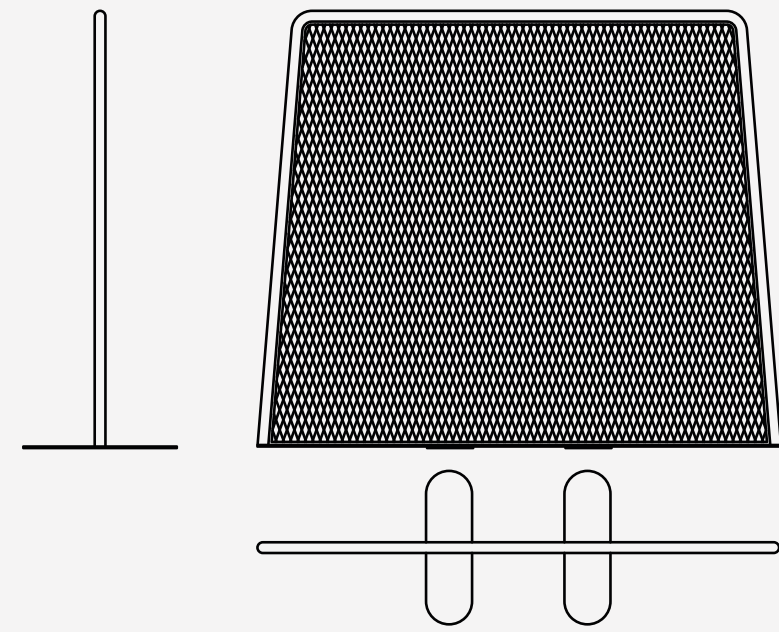

**Sarek
L deployé divider**

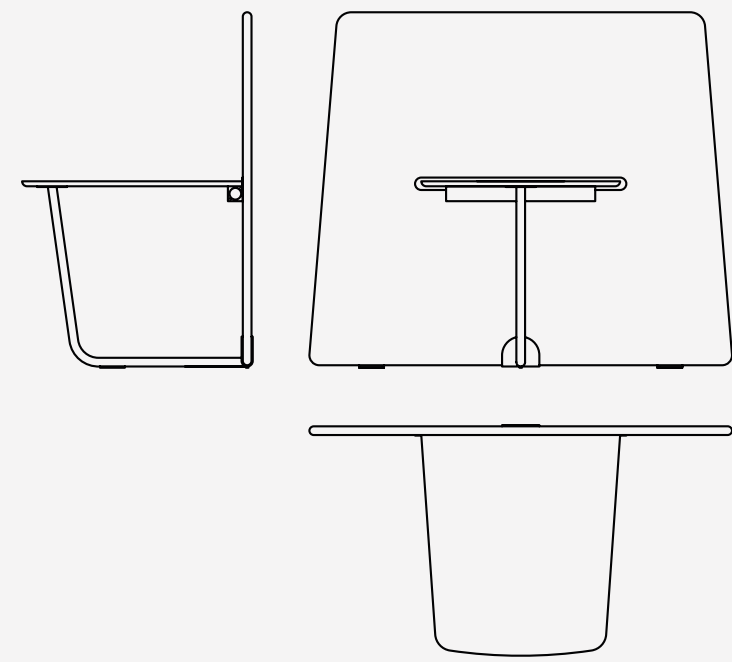

**Sarek
High Fabric Divider + Table**

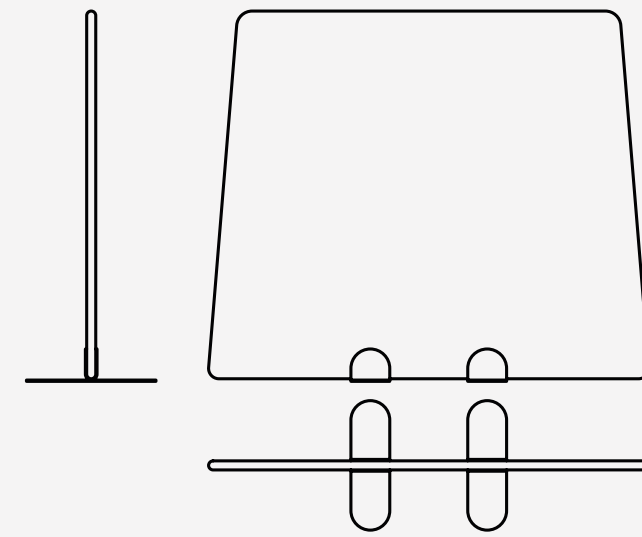

**Sarek
High Fabric Divider**

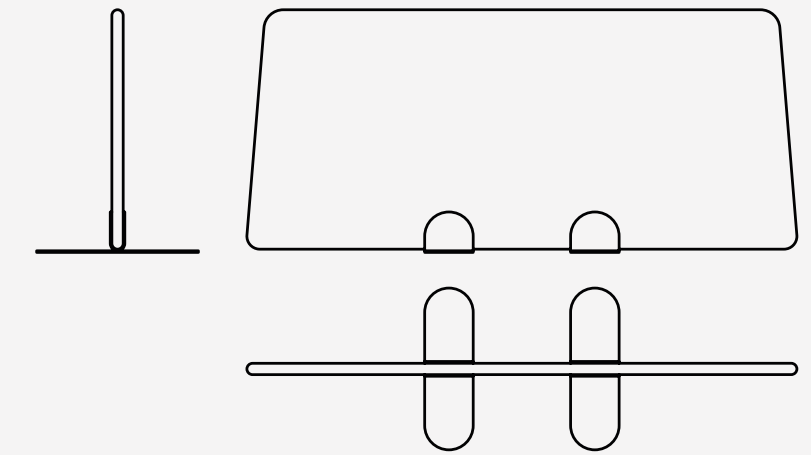

**Sarek
Low Fabric Divider**

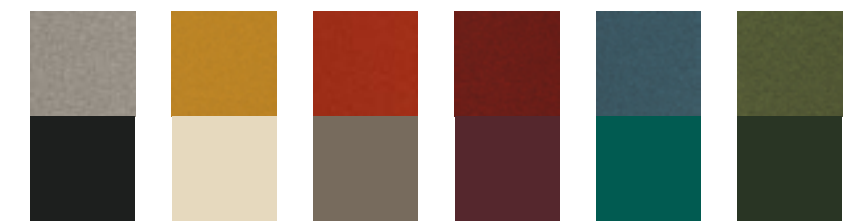
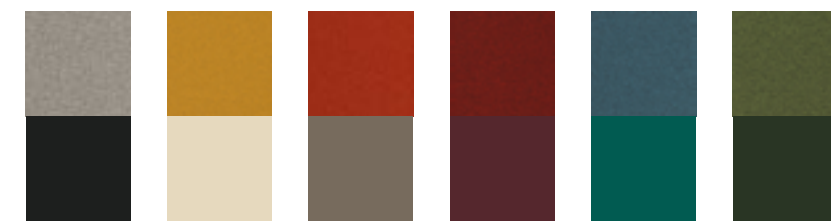
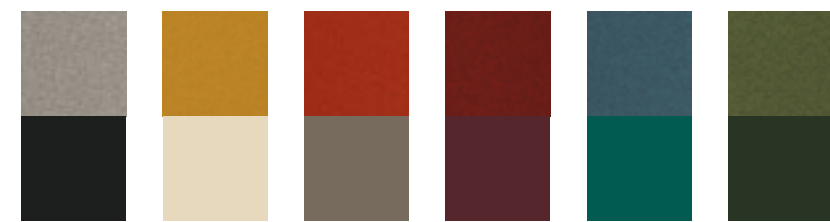

METAL LACQUERED



UPHOLSTERY (GABRIEL)

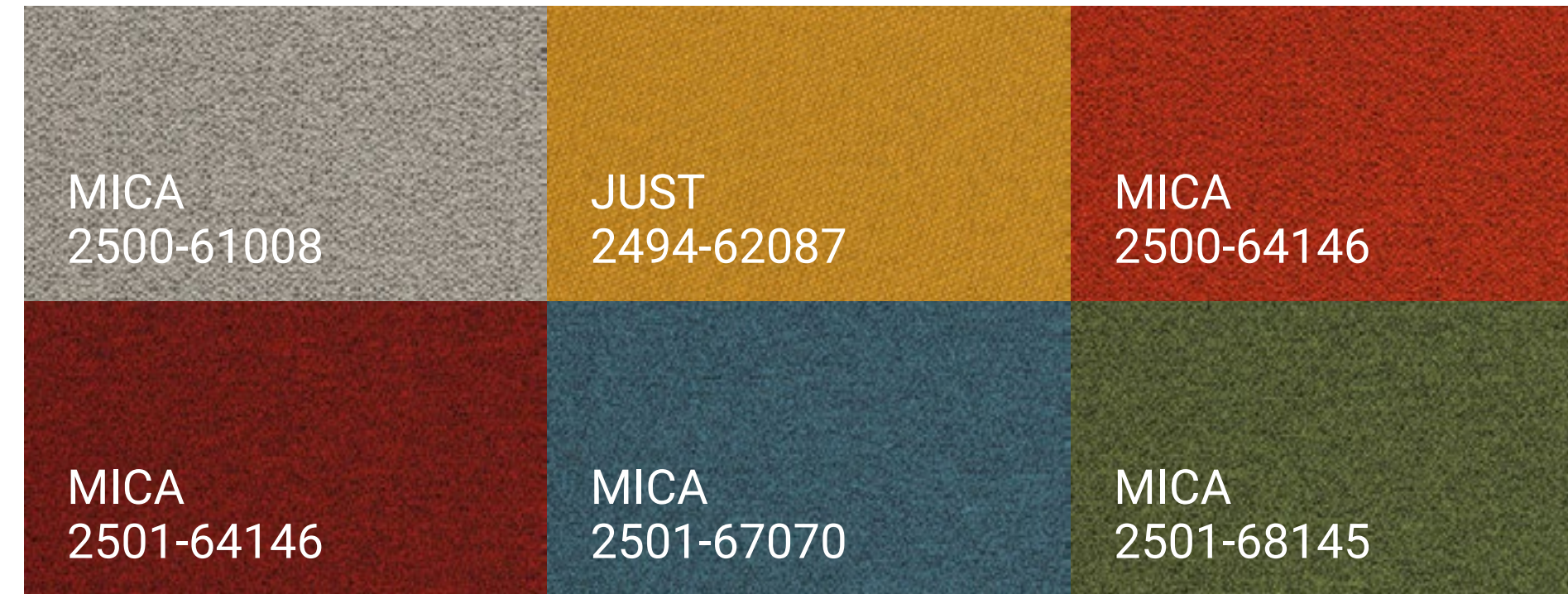

BOARDS

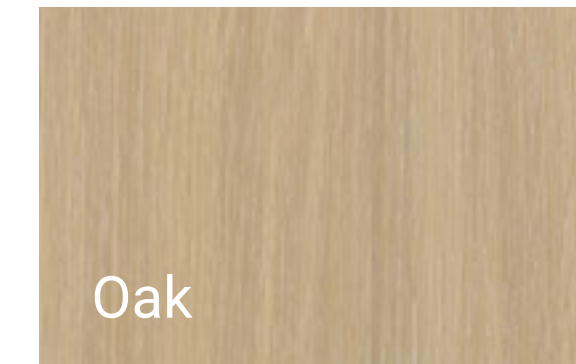

Environments with character

The shades available for the Sarek collection allow us to use color to design creative, customized spaces that will adapt to all architectural styles. For corporate environments, you can customize the shades on demand.

Mobile and fixed arrangements

In environments that require flexibility, the weight of the modules is perfect to re-arrange them or to always keep the modules in the same place. Permanent structures used in shared spaces can be fixed with a clip.

Designers

Stone Designs is a cross-disciplinary design studio. It is based in Madrid but works worldwide on projects for interior design or products. This studio attended a special course on Flexyskin before working with Bōln on the design of the Sarek collection. A versatile modular system created with their own experience in designing interiors and heavy-duty shared spaces.

STONE-DSGNS.COM



Böln

ABISKO

— STOOLS



welcome
outside

BÖLN ED

**A soft, organic design
that is solid and provides a
great performance**

The rounded shape of the Abisko stools help design welcoming, serene atmospheres in shared spaces. These heavy-duty pieces are very stable and extremely resilient as well as highly efficient.

ABISKO

BOLN . EU

welcome
outside



**One design,
three styles**

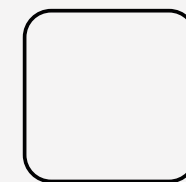
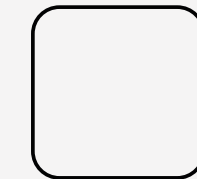
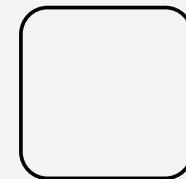
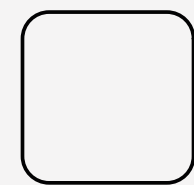
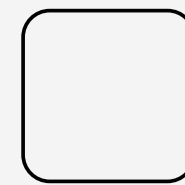
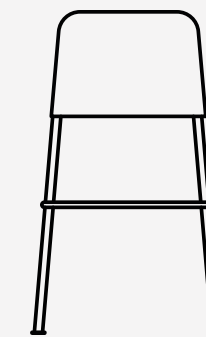
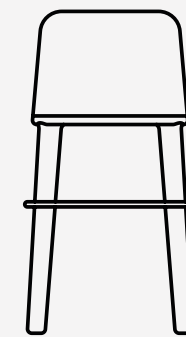
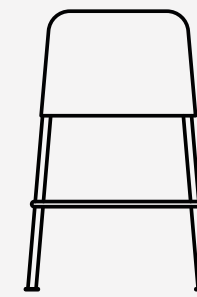
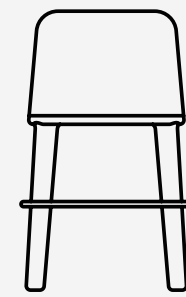
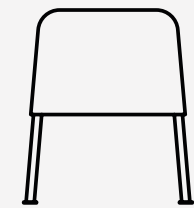
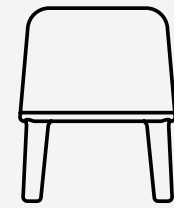

**Abisko 45
Wooden Legs**

**Abisko 45
Metal Legs**

**Abisko 65
Wooden Legs**

**Abisko 65
Metal Legs**

**Abisko 75
Wooden Legs**

**Abisko 75
Metal Legs**

METAL LACQUERED

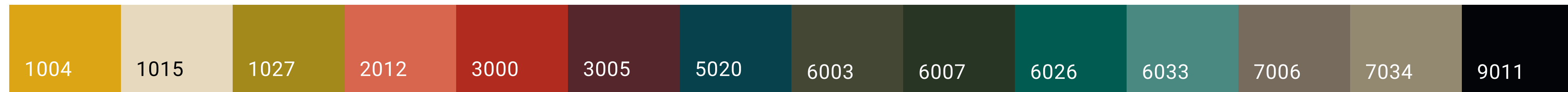

**Experience
above all**

These are comfortable, pleasant and resilient stools that have been specially designed to improve people's experience in shared spaces. The measurements of these stools were analyzed in detail to make them efficient.

**The essence of
their charm**

Their refined design, stripped down to the essence of what is strictly necessary, is completed with a range of 13 shades that allow you to use color to create very rich and striking projects. You can also customize the shades on demand.

Designers

Stone Designs is a cross-disciplinary design studio. It is based in Madrid but works worldwide on projects for interior design or products. This studio attended a special course on Flexyskin before working with Bōln on the development of the Abisko collection. A stylish range of stools created with their own experience in designing interiors and heavy-duty shared spaces.

STONE-DSGNS.COM



#BOLNSYSTEM

Bōln

BOLN.EU