

ALONDRA

BABY FURNITURE & DECOR



CATALOGUE

2018

CONVERTIBLE CRIBS | CUNAS CONVERTIBLES | LITS BÉBÉ ÉVOLUTIFS VERWANDELBARE BABYBETTEN | LETTINI TRASFORMABILI

GLOSS
FINISH

Gloss finish
Acabado en color brillo
Finition brillante
Glanzausführung
Finitura lucida

MATTE
FINISH

Matte finish
Acabado en color mate
Finition mate
Matteausführung
Finitura opaca

60x120
90x200

Cot 60x120 cm convertible in bed 90x200 cm
Cuna de 60x120 cm transformable en cama de 90x200 cm
Lit bébé 60x120 cm transformable en lit 90x200 cm
Babybett 60x120 cm wandelbar in ein Bett 90x200 cm
Lettino 60x120 cm trasformabile in letto 90x200 cm

70x140
90x200

Cot 70x140 cm convertible in bed 90x200 cm
Cuna de 70x140 cm transformable en cama de 90x200 cm
Lit bébé 70x140 cm transformable en lit 90x200 cm
Babybett 70x140 cm wandelbar in ein Bett 90x200 cm
Lettino 70x140 cm trasformabile in letto 90x200 cm

KONVERS

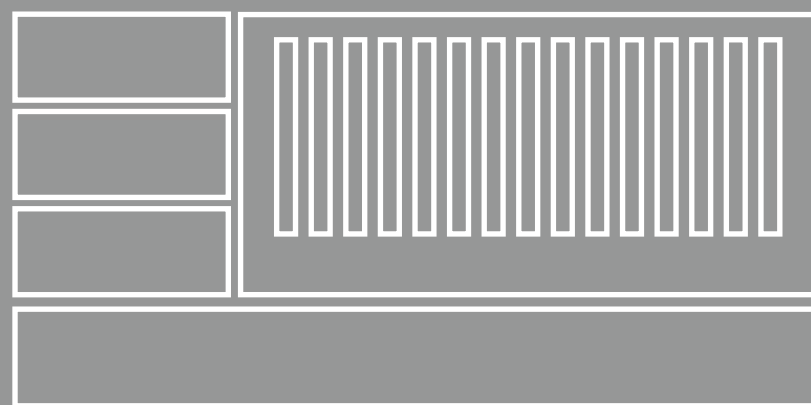

CONVERTIBLE CRIBS | CUNAS CONVERTIBLES | LITS BÉBÉ ÉVOLUTIFS
VERWANDELBARE BABYBETTEN | LETTINI TRASFORMABILI



K379-M7700

JUST JOY **WHITE**



K379-M7778

JUST JOY **GREY**



K379-M7779

JUST JOY **ETNIK**



K379-M7781

JUST JOY **MARE**



K379-M7782

JUST JOY **ROSE**

2 STAGES | 2 ETAPAS | 2 ÉTAPES | 2 ETAPPEN | 2 FASI

BABY
0-3
years



Convertible crib | Cuna convertible
Lit bébé évolutif | *Verwandelbares Babybett*
Lettino trasformabile



Optional drawers | Cajones adicionales
Tiroirs additionnels | *Zusätzliche Schubladen*
Cassetti aggiuntivi

JUNIOR
+3
years



Convertible crib as bedroom | Cuna convertible desmontada como habitación
Lit bébé évolutif transformé en chambre | *Verwandelbares Babybett als Jugendzimmer*
Lettino trasformabile montato a cameretta

101,5 x 205,6 x 120 cm

JUST JOY

KONVERS

CONVERTIBLE CRIBS | CUNAS CONVERTIBLES
LITS BÉBÉ ÉVOLUTIFS | VERWANDELBARE BABYBETTEN | LETTINI TRASFORMABILI

60x120
90x200

BABY
0-3
years

MATTE
FINISH



K379-M7782
60 x 120 cm » 90 x 200 cm

101,5 x 173,2 x 67,2 cm
↑ → ↻

JUST JOY **ROSE**

KONVERS

1

BABY
0-3
years



105,5 x 206,4 x 102 cm

Convertible crib | Cuna convertible
Lit bébé évolutif | *Verwandelbares Babybett*
Letino trasformabile

2

KID
3-5
years



105,5 x 206,4 x 102 cm

Convertible crib as cot with additional modules | Cuna convertible montada con módulos adicionales
Lit bébé évolutif avec des modules supplémentaires | *Verwandelbares Babybett als Kinderbett mit Zusatzmodulen*
Letino trasformabile montato con moduli aggiuntivi

3

JUNIOR
+5
years



37,5 x 206,4 x 102 cm

Junior bed | Cama junior
Lit | Bett | Letto

Convertible crib as junior bedroom | Cuna convertible desmontada como habitación infantil | Lit bébé évolutif transformé en chambre junior
Verwandelbares Babybett als Jugendzimmer | Letino trasformabile montato a cameretta

SERO JOY

KONVERS

CONVERTIBLE CRIBS | CUNAS CONVERTIBLES
LITS BÉBÉ ÉVOLUTIFS | VERWANDELBARE BABYBETTEN | LETTINI TRASFORMABILI

70x140
90x200

MATTE
FINISH

SERO JOY **MARE**

KONVERS



● K559C-M7778
▲ K559N-M7778

SERO JOY **GREY**



● K559C-M7779
▲ K559N-M7779

SERO JOY **ETNIK**



● K559C-M7781
▲ K559N-M7781

SERO JOY **MARE**



● K559C-M7782
▲ K559N-M7782

SERO JOY **ROSE**

OPTIONS | OPCIONES | OPTIONS | OPTIONEN | OPZIONI



● **Convertible crib with drawers** | Cuna convertible con cajones inferiores
Lit bébé évolutif avec tiroirs | *Verwandelbares Babybett mit Schubladen*
Letino trasformabile con cassettoni



▲ **Convertible crib with trundle bed** | Cuna convertible con cama nido
Lit bébé évolutif avec lit gigogne | *Verwandelbares Babybett mit Ausziehbett*
Letino trasformabile con letto estraibile

SERO JOY WHITE

70x140
90x200

MATTE
FINISH



● K559C-M7700 ▲ K559N-M7700
70x140cm » 90x200cm

KONVERS



K376-M7700

JUST EVEN **WHITE**



K376-M7751

JUST EVEN **CIELO**



K376-M7752

JUST EVEN **CORAL**



K376-M7753

JUST EVEN **ARENA**



K376-M7778

JUST EVEN **GREY**

2 STAGES | 2 ETAPAS | 2 ÉTAPES | 2 ETAPPEN | 2 FASI

BABY
0-3
years



Convertible crib | Cuna convertible
Lit bébé évolutif | *Verwandelbares Babybett*
Lettino trasformabile

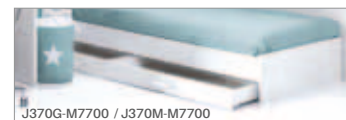

Optional drawers | Cajones adicionales
Tiroirs additionnels | *Zusätzliche Schubladen*
Cassetti aggiuntivi

JUNIOR
+3
years



Convertible crib as bedroom | Cuna convertible desmontada como habitación
Lit bébé évolutif transformé en chambre | *Verwandelbares Babybett als Jugendzimmer*
Lettino trasformabile montato a cameretta

JUST EVEN

KONVERS

CONVERTIBLE CRIBS | CUNAS CONVERTIBLES
LITS BÉBÉ ÉVOLUTIFS | VERWANDELBARE BABYBETTEN | LETTINI TRASFORMABILI

60x120
90x200

BABY
0-3
years

MATTE
FINISH



101,5 x 173,2 x 67,2 cm
↑ → ↻

K376-M7781
60 x 120 cm » 90 x 200 cm

JUST EVEN MARE

KONVERS



K374-M7700

JUST BUBBLE **WHITE**



K374-M7751

JUST BUBBLE **CIELO**



K374-M7752

JUST BUBBLE **CORAL**



K374-M7753

JUST BUBBLE **ARENA**



K374-M7778

JUST BUBBLE **GREY**

2 STAGES | 2 ETAPAS | 2 ÉTAPES | 2 ETAPPEN | 2 FASI

BABY
0-3
years

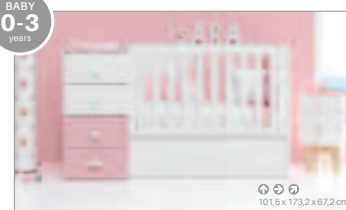

Convertible crib | Cuna convertible
Lit bébé évolutif | *Verwandelbares Babybett*
Lettino trasformabile

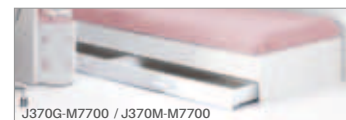

Optional drawers | Cajones adicionales
Tiroirs additionnels | *Zusätzliche Schubladen*
Cassetti aggiuntivi

JUNIOR
+3
years

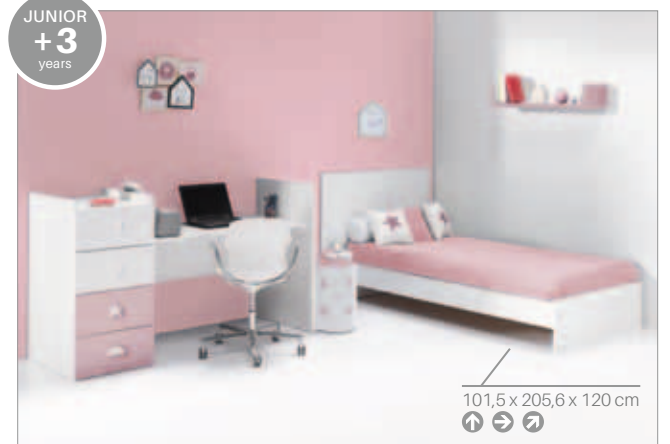

Convertible crib as bedroom | Cuna convertible desmontada como habitación
Lit bébé évolutif transformé en chambre | *Verwandelbares Babybett als Jugendzimmer*
Lettino trasformabile montato a cameretta

101,5 x 205,6 x 120 cm

JUST BUBBLE

KONVERS

CONVERTIBLE CRIBS | CUNAS CONVERTIBLES
LITS BÉBÉ ÉVOLUTIFS | VERWANDELBARE BABYBETTEN | LETTINI TRASFORMABILI

60x120
90x200

BABY
0-3
years

MATTE
FINISH



K374-M7752
60 x 120 cm » 90 x 200 cm

101,5 x 173,2 x 67,2 cm
↑ → ↻

JUST BUBBLE CORAL

KONVERS



BABY
0-3
years

101,7 x 208,1 x 101,8 cm

Convertible crib | Cuna convertible
Lit bébé évolutif | *Verwandelbares Babybett*
Letino trasformabile



KID
3-5
years

101,7 x 208,1 x 101,8 cm

Convertible crib as cot with additional modules | Cuna convertible montada con módulos adicionales
Lit bébé évolutif avec des modules supplémentaires | *Verwandelbares Babybett als Kinderbett mit Zusatzmodulen*
Letino trasformabile montato con moduli aggiuntivi



JUNIOR
+5
years

101,7 x 208,1 x 101,8 cm

Junior bed | Cama junior
Lit | Bett | Letto

Convertible crib as junior bedroom | Cuna convertible desmontada como habitación infantil | Lit bébé évolutif transformé en chambre junior
Verwandelbares Babybett als Jugendzimmer | Letino trasformabile montato a cameretta

NEO MODULAR

KONVERS

CONVERTIBLE CRIBS | CUNAS CONVERTIBLES

LITS BÉBÉ ÉVOLUTIFS | VERWANDELBARE BABYBETTEN | LETTINI TRASFORMABILI

70x140
90x200

GLOSS
FINISH



101,7 x 208,1 x 101,8 cm
↑ → ↻

NEO *
● K501C-G2335 ▲ K501N-G2335

70 x 140 cm » 90 x 200 cm

NEO PLUS **
● K601C-G2335 ▲ K601N-G2335

70 x 140 cm » 90 x 200 cm

NEO MODULAR PEARL

KONVERS

2 COLOURS | 2 COLORES | 2 COULEURS | 2 FARBEN | 2 COLORI

GLOSS
FINISH



NEO *
● K501C-G2300 ▲ K501N-G2300

NEO PLUS **
● K601C-G2300 ▲ K601N-G2300

NEO MODULAR ARTIK



NEO *
● K501C-G2335 ▲ K501N-G2335

NEO PLUS **
● K601C-G2335 ▲ K601N-G2335

NEO MODULAR PEARL

OPTIONS | OPCIONES | OPTIONS | OPTIONEN | OPZIONI



● **Convertible crib with drawers** | Cuna convertible con cajones inferiores
Lit bébé évolutif avec tiroirs | *Verwandelbares Babybett mit Schubladen*
Letino trasformabile con cassettoni



▲ **Convertible crib with trundle bed** | Cuna convertible con cama nido
Lit bébé évolutif avec lit gigogne | *Verwandelbares Babybett mit Ausziehbett*
Letino trasformabile con letto estraibile

NEO MODULAR*

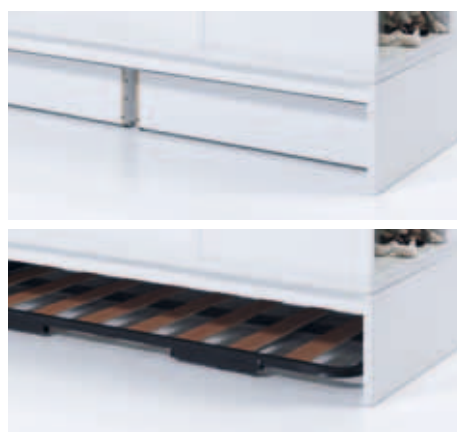

Board bed base | Somier de tablas | Sommier en planche
Bettrost: Platte | Rete a pannelli

Back view | Vista trasera
Vue arrière | *Rückwärtige Ansicht*
Vista dal retro

NEO PLUS MODULAR**



Back view | Vista trasera
Vue arrière | *Rückwärtige Ansicht*
Vista dal retro



Slatted bed base | Somier de lamas
Sommier à lattes | *Lattenrost*
Rete a doghe

NEO MODULAR ARTIK

70x140
90x200

GLOSS
FINISH



101,7 x 208,1 x 101,8 cm
↑ → ↻

NEO *
● K501C-G2300 ▲ K501N-G2300

70x140 cm » 90x200 cm

NEO PLUS **
● K601C-G2300 ▲ K601N-G2300

70x140 cm » 90x200 cm

KONVERS

1

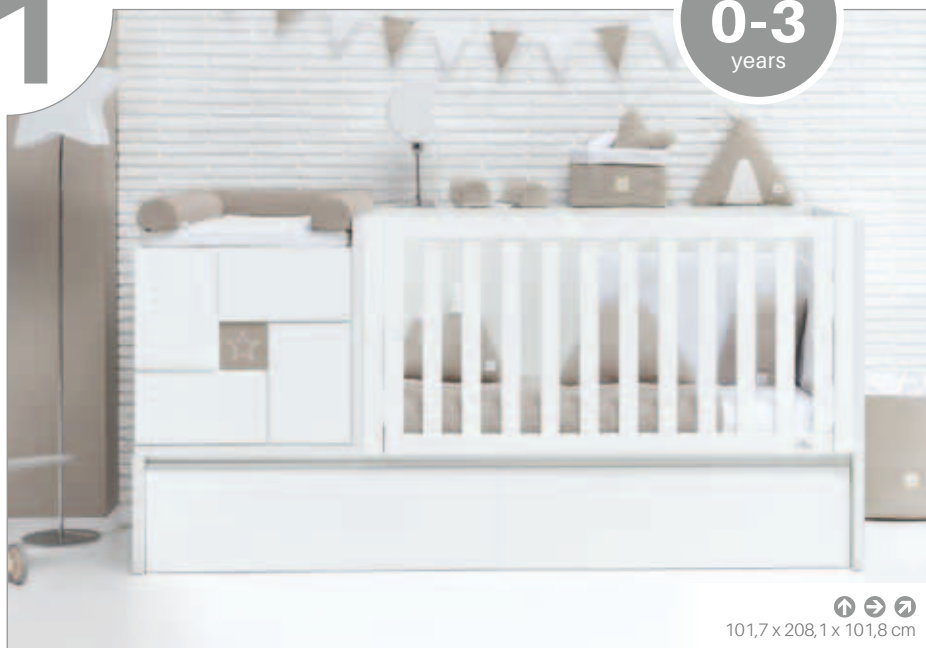

BABY
0-3
years

101,7 x 208,1 x 101,8 cm

Convertible crib | Cuna convertible
Lit bébé évolutif | *Verwandelbares Babybett*
Letino trasformabile

2



KID
3-5
years

101,7 x 208,1 x 101,8 cm

Convertible crib as cot with additional modules | Cuna convertible montada con módulos adicionales
Lit bébé évolutif avec des modules supplémentaires | *Verwandelbares Babybett als Kinderbett mit Zusatzmodulen*
Letino trasformabile montato con moduli aggiuntivi

3

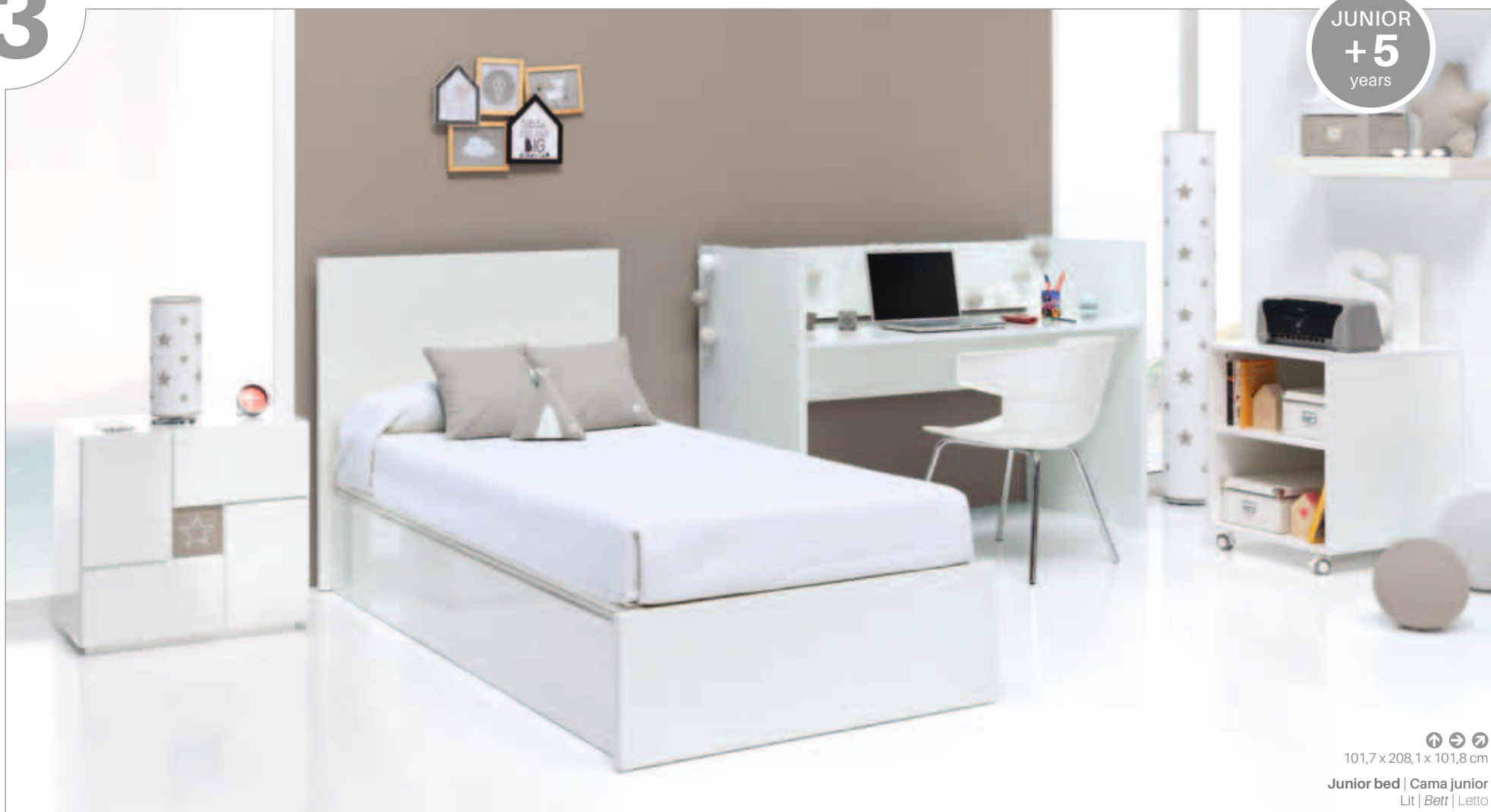

JUNIOR
+5
years

101,7 x 208,1 x 101,8 cm

Junior bed | Cama junior
Lit | Bett | Letto

Convertible crib as junior bedroom | Cuna convertible desmontada como habitación infantil | Lit bébé évolutif transformé en chambre junior
Verwandelbares Babybett als Jugendzimmer | Letino trasformabile montato a cameretta

NEO CLIP

KONVERS

CONVERTIBLE CRIBS | CUNAS CONVERTIBLES
LITS BÉBÉ ÉVOLUTIFS | VERWANDELBARE BABYBETTEN | LETTINI TRASFORMABILI

GLOSS
FINISH

70x140
90x200



K506C-G2353 / K606C-G2353

101,7 x 208,1 x 101,8 cm
↑ ↓ ↻

70 x 140 cm > 90 x 200 cm

NEO CLIP ARENA

KONVERS

8 COLOURS | 8 COLORES | 8 COULEURS | 8 FARBEN | 8 COLORI

GLOSS
FINISH



- NEO * NEO PLUS **
- K506C-G2300 ● K606C-G2300
 - ▲ K506N-G2300 ▲ K606N-G2300

NEO CLIP **ARTIK**

- NEO * NEO PLUS **
- K506C-G2335 ● K606C-G2335
 - ▲ K506N-G2335 ▲ K606N-G2335

NEO CLIP **PEARL**



- NEO * NEO PLUS **
- K506C-G2353 ● K606C-G2353
 - ▲ K506N-G2353 ▲ K606N-G2353

NEO CLIP **ARENA**

- NEO * NEO PLUS **
- K506C-G2379 ● K606C-G2379
 - ▲ K506N-G2379 ▲ K606N-G2379

NEO CLIP **ETNIK**

OPTIONS | OPCIONES | OPTIONS | OPTIONEN | OPZIONI



● **Convertible crib with drawers** | Cuna convertible con cajones inferiores
Lit bébé évolutif avec tiroirs | *Verwandelbares Babybett mit Schubladen*
Letino trasformabile con cassettoni



▲ **Convertible crib with trundle bed** | Cuna convertible con cama nido
Lit bébé évolutif avec lit gigogne | *Verwandelbares Babybett mit Ausziehbett*
Letino trasformabile con letto estraibile

70x140
90x200

NEO CLIP

KONVERS



NEO *

● K506C-G2351

▲ K506N-G2351

NEO PLUS **

● K606C-G2351

▲ K606N-G2351

NEO CLIP CIELO



NEO *

● K506C-G2352

▲ K506N-G2352

NEO PLUS **

● K606C-G2352

▲ K606N-G2352

NEO CLIP CORAL



NEO *

● K506C-G2381

▲ K506N-G2381

NEO PLUS **

● K606C-G2381

▲ K606N-G2381

NEO CLIP MARE



NEO *

● K506C-G2392

▲ K506N-G2392

NEO PLUS **

● K606C-G2392

▲ K606N-G2392

NEO CLIP COCO

NEO CLIP*



Back view | Vista trasera
Vue arrière | Rückwärtige Ansicht
Vista dal retro



Board bed base | Somier de tablas
Sommier en planche | Bettrost: Platte
Rete a pannelli

NEO PLUS CLIP**



Back view | Vista trasera
Vue arrière | Rückwärtige Ansicht
Vista dal retro



Slatted bed base | Somier de lamas
Sommier à lattes | Lattenrost
Rete a doghe

1

BABY
0-3
years



103,4 x 214,1 x 101,8 cm

Convertible crib | Cuna convertible
Lit bébé évolutif | *Verwandelbares Babybett*
Lettino trasformabile

2

KID
3-5
years



103,4 x 214,1 x 101,8 cm

Convertible crib as cot with additional modules | Cuna convertible montada con módulos adicionales
Lit bébé évolutif avec des modules supplémentaires | *Verwandelbares Babybett als Kinderbett mit Zusatzmodulen*
Lettino trasformabile montato con moduli aggiuntivi

3

JUNIOR
+5
years



101,7 x 214,1 x 101,8 cm

Junior bed | Cama junior
Lit | Bett | Letto

Convertible crib as junior bedroom | Cuna convertible desmontada como habitación infantil | Lit bébé évolutif transformé en chambre junior
Verwandelbares Babybett als Jugendzimmer | Lettino trasformabile montato a cameretta

PREMIUM KURVE

KONVERS

CONVERTIBLE CRIBS | CUNAS CONVERTIBLES

LITS BÉBÉ ÉVOLUTIFS | VERWANDELBARE BABYBETTEN | LETTINI TRASFORMABILI

70x140
90x200

MATTE
FINISH



103,4 x 214,1 x 101,8 cm
↑ → ↻

K417CR-M7778

70 x 140 cm » 90 x 200 cm

KURVE GREY

KONVERS



● K417CL-M7700
K417CR-M7700

▲ K417NL-M7700
K417NR-M7700



● K417CL-M7778
K417CR-M7778

▲ K417NL-M7778
K417NR-M7778

KURVE **WHITE**

KURVE **GREY**



● K417CL-M7791
K417CR-M7791

▲ K417NL-M7791
K417NR-M7791



● K417CL-M7792
K417CR-M7792

▲ K417NL-M7792
K417NR-M7792

KURVE **NATURE**

KURVE **COCO**

MATTE
FINISH

PREMIUM KURVE

KONVERS

OPTIONS | OPCIONES | OPTIONS | OPTIONEN | OPZIONI



● **K417CL** Convertible crib with drawers (dropside on the left)
Cuna convertible con cajones inferiores (barandilla a la izquierda)
Lit bébé évolutif avec tiroirs (barrière à gauche)
Verwendbares Babybett mit Schubladen (Gitter links)
Letтино trasformabile con cassettoni (Sponda montata a sinistra)



▲ **K417NL** Convertible crib with trundle bed (dropside on the left)
Cuna convertible con cama nido (barandilla a la izquierda)
Lit bébé évolutif avec lit gigogne (barrière à gauche)
Verwendbares Babybett mit Ausziehbett (Gitter links)
Letтино trasformabile con letto estraibile (Sponda montata a sinistra)



● **K417CR** Convertible crib with drawers (dropside on the right)
Cuna convertible con cajones inferiores (barandilla a la derecha)
Lit bébé évolutif avec tiroirs (barrière à droite)
Verwendbares Babybett mit Schubladen (Gitter rechts)
Letтино trasformabile con cassettoni (Sponda montata a destra)



▲ **K417NR** Convertible crib with trundle bed (dropside on the right)
Cuna convertible con cama nido (barandilla a la derecha)
Lit bébé évolutif avec lit gigogne (barrière à droite)
Verwendbares Babybett mit Ausziehbett (Gitter rechts)
Letтино trasformabile con letto estraibile (Sponda montata a destra)

KONVERS

1

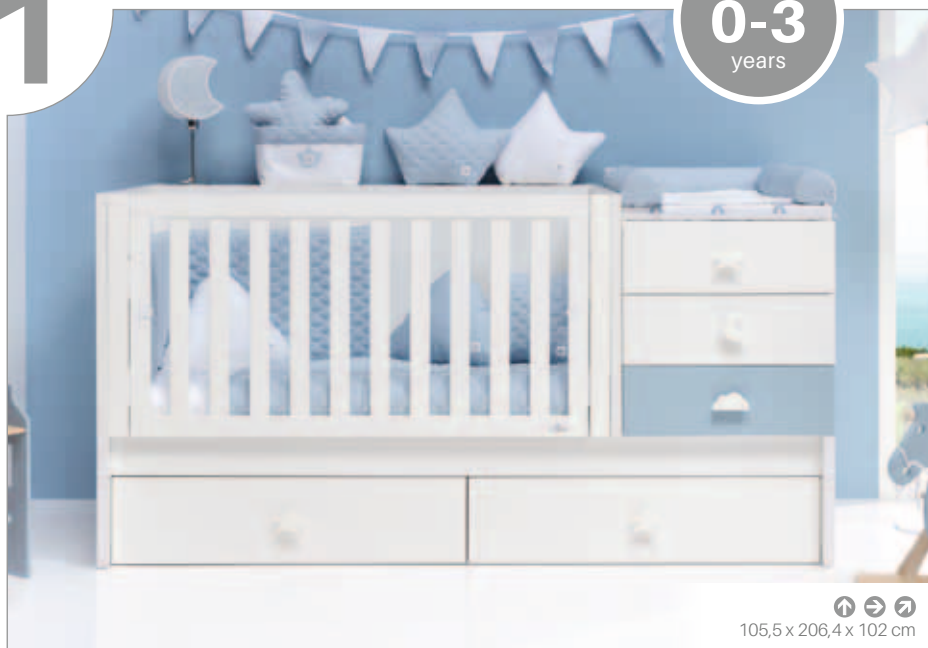

BABY
0-3
years

105,5 x 206,4 x 102 cm

Convertible crib | Cuna convertible
Lit bébé évolutif | *Verwandelbares Babybett*
Lettino trasformabile

2



KID
3-5
years

105,5 x 206,4 x 102 cm

Convertible crib as cot with additional modules | Cuna convertible montada con módulos adicionales
Lit bébé évolutif avec des modules supplémentaires | *Verwandelbares Babybett als Kinderbett mit Zusatzmodulen*
Lettino trasformabile montato con moduli aggiuntivi

3



JUNIOR
+5
years

37,5 x 206,4 x 102 cm

Junior bed | Cama junior
Lit | Bett | Letto

Convertible crib as junior bedroom | Cuna convertible desmontada como habitación infantil | Lit bébé évolutif transformé en chambre junior
Verwandelbares Babybett als Jugendzimmer | Lettino trasformabile montato a cameretta

SERO BUBBLE

KONVERS

CONVERTIBLE CRIBS | CUNAS CONVERTIBLES
LITS BÉBÉ ÉVOLUTIFS | VERWANDELBARE BABYBETTEN | LETTINI TRASFORMABILI

70x140
90x200

MATTE
FINISH



K554C-M7751

70 x 140 cm » 90 x 200 cm

105,5 x 206,4 x 102 cm
↑ → ↻

SERO BUBBLE **CIELO**

KONVERS

5 COLOURS | 5 COLORES | 5 COULEURS | 5 FARBEN | 5 COLORI

MATTE
FINISH



● K554C-M7700
▲ K554N-M7700

SERO BUBBLE **WHITE**



● K554C-M7751
▲ K554N-M7751

SERO BUBBLE **CIELO**



● K554C-M7752
▲ K554N-M7752

SERO BUBBLE **CORAL**



● K554C-M7753
▲ K554N-M7753

SERO BUBBLE **ARENA**

OPTIONS | OPCIONES | OPTIONS | OPTIONEN | OPZIONI



● **Convertible crib with drawers** | Cuna convertible con cajones inferiores
Lit bébé évolutif avec tiroirs | *Verwandelbares Babybett mit Schubladen*
Letino trasformabile con cassettoni



▲ **Convertible crib with trundle bed** | Cuna convertible con cama nido
Lit bébé évolutif avec lit gigogne | *Verwandelbares Babybett mit Ausziehbett*
Letino trasformabile con letto estraibile

SERO BUBBLE GREY

70x140
90x200

MATTE
FINISH



● K554C-M7778 ▲ K554N-M7778

70 x 140 cm » 90 x 200 cm

KONVERS

1

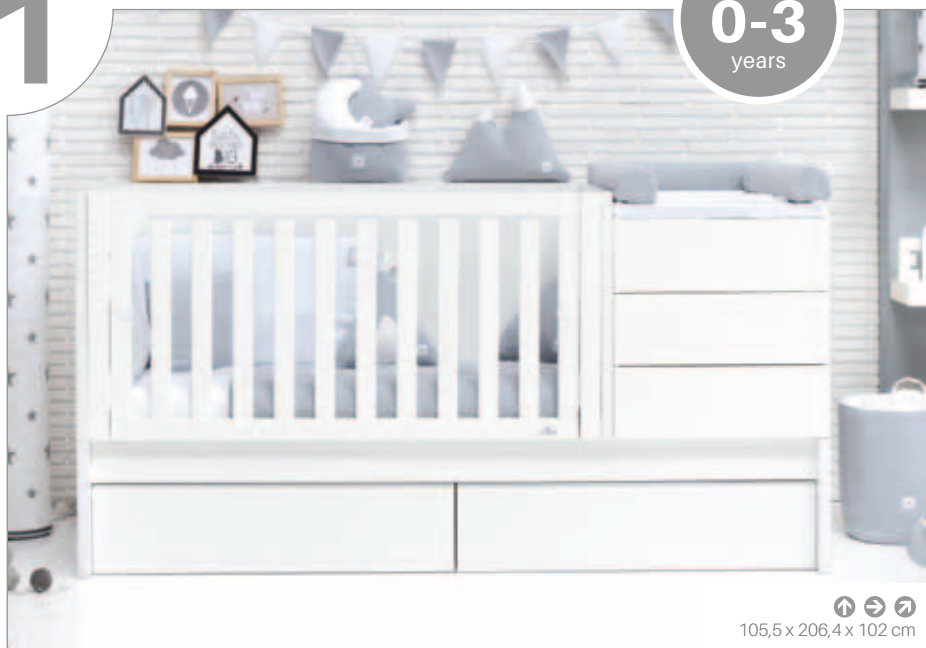

BABY
0-3
years

105,5 x 206,4 x 102 cm

Convertible crib | Cuna convertible
Lit bébé évolutif | *Verwandelbares Babybett*
Lettino trasformabile

2



KID
3-5
years

105,5 x 206,4 x 102 cm

Convertible crib as cot with additional modules | Cuna convertible montada con módulos adicionales
Lit bébé évolutif avec des modules supplémentaires | *Verwandelbares Babybett als Kinderbett mit Zusatzmodulen*
Lettino trasformabile montato con moduli aggiuntivi

3



JUNIOR
+5
years

37,5 x 206,4 x 102 cm

Junior bed | Cama junior
Lit | Bett | Letto

Convertible crib as junior bedroom | Cuna convertible desmontada como habitación infantil | Lit bébé évolutif transformé en chambre junior
Verwandelbares Babybett als Jugendzimmer | Lettino trasformabile montato a cameretta

SERO EVEN

KONVERS

CONVERTIBLE CRIBS | CUNAS CONVERTIBLES
LITS BÉBÉ ÉVOLUTIFS | VERWANDELBARE BABYBETTEN | LETTINI TRASFORMABILI

70x140
90x200

MATTE
FINISH

105,5 x 206,4 x 102 cm
↑ → ↻

K536C-M7700

70 x 140 cm » 90 x 200 cm

SERO EVEN WHITE

KONVERS



● K536C-M7700
▲ K536N-M7700

SERO EVEN **WHITE**



● K536C-M7751
▲ K536N-M7751

SERO EVEN **CIELO**



● K536C-M7752
▲ K536N-M7752

SERO EVEN **CORAL**



● K536C-M7753
▲ K536N-M7753

SERO EVEN **ARENA**



● K536C-M7778
▲ K536N-M7778

SERO EVEN **GREY**



● K536C-M7781
▲ K536N-M7781

SERO EVEN **MARE**

SERO EVEN

KONVERS

OPTIONS | OPCIONES | OPTIONS | OPTIONEN | OPZIONI



70x140
90x200

Convertible crib with drawers
Cuna convertible con cajones inferiores
Lit bébé évolutif avec tiroirs
Verwendbares Babybett mit Schubladen
Letino trasformabile con cassettoni



Convertible crib with trundle bed
Cuna convertible con cama nido
Lit bébé évolutif avec lit gigogne
Verwendbares Babybett mit Ausziehbett
Letino trasformabile con letto estraibile

KONVERS

BABY FURNITURE | MOBILIARIO INFANTIL

MOBILIER BÉBÉ | *BABYMÖBEL* | MOBILI PER BAMBINI



Matte finish
Acabado en color mate
Finition mate
Matteausführung
Finitura opaca



Cot 60x120 cm convertible in bed 90x200 cm
Cuna de 60x120 cm transformable en cama de 90x200 cm
Lit bébé 60x120 cm transformable en lit 90x200 cm
Babybett 60x120 cm verwandelbar in ein Bett 90x200 cm
Lettino 60x120 cm trasformabile in letto 90x200 cm

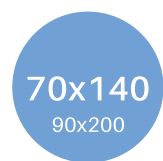

Cot 70x140 cm convertible in bed 90x200 cm
Cuna de 70x140 cm transformable en cama de 90x200 cm
Lit bébé 70x140 cm transformable en lit 90x200 cm
Babybett 70x140 cm verwandelbar in ein Bett 90x200 cm
Lettino 70x140 cm trasformabile in letto 90x200 cm

BABY FURNITURE

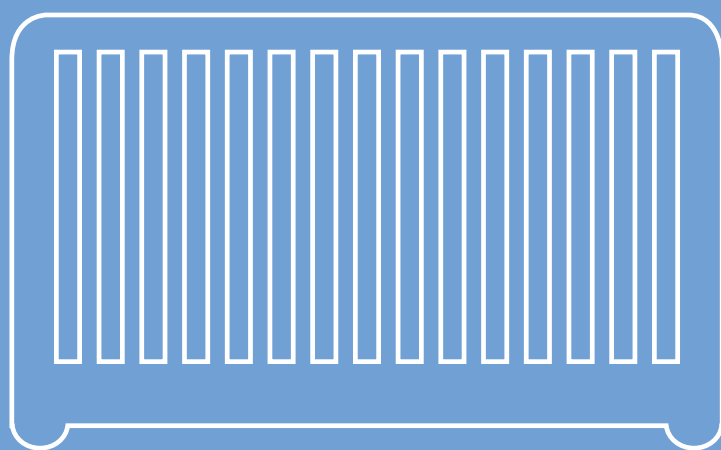

BABY FURNITURE | MOBILIARIO INFANTIL
MOBILIER BÉBÉ | *BABYMÖBEL* | MOBILI PER BAMBINI

GLOSS
FINISH

BABY ROOMS | HABITACIONES INFANTILES

CHAMBRES DE BÉBÉ | *BABYZIMMER* | CAMERETTE PER BAMBINI

Wardrobes | Armarios | Armoires | *Schränke* | Armadi

Chests | Cómodos | Commodes | *Kommoden* | Cassettiere



V656-G2300

Optional changer support
Soporte vestidor opcional
Plan à langer supplémentaire
Zusätzlicher Wickelaufsatz
Supporto fasciatoio supplementare

A306

↑ 201,8 cm → 110,2 cm ↻ 61,8 cm

- A306-G2300
- A306-G2335
- A306-G2351
- A306-G2352
- A306-G2353
- A306-G2379
- A306-G2381

A306P

↑ 205,8 cm → 110,2 cm ↻ 61,8 cm

- A306P-G2392

D206

↑ 87,3 cm → 96,5 cm ↻ 47,9 cm

- D206-G2300
- D206-G2335
- D206-G2351
- D206-G2352
- D206-G2353
- D206-G2379
- D206-G2381

D206P

↑ 91,3 cm → 96,5 cm ↻ 47,9 cm

- D206P-G2392

60 x 120 cm

Cots | Cunas | Lits bébé | *Babybetten* | Lettini



Cot 60x120 | Cuna 60x120 | Lit bébé 60x120
Babybett 60x120 | Lettino 60x120

C150

↑ 80 cm → 132 cm ↻ 64 cm

- C150-G2300
- C150-G2335

70 x 140 cm

Cots | Cunas | Lits bébé | *Babybetten* | Lettini



Cot 70x140 | Cuna 70x140 | Lit bébé 70x140
Babybett 70x140 | Lettino 70x140

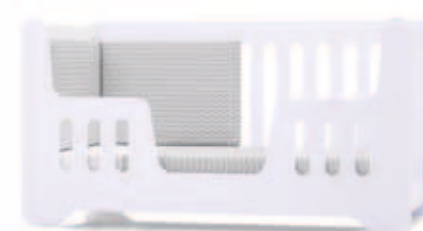

Toddler bed | Cama infantil | Lit cadet
Kinderbett | Letto

C160

↑ 79,5 cm → 150 cm ↻ 74,1 cm

- C160-G2300
- C160-G2335

CLIP

BABY ROOMS

GLOSS
FINISH



CLIP ARENA

BABY FURNITURE



CLIP ARTIK



CLIP PEARL



CLIP ARENA



CLIP ETNIK

CLIP

BABY ROOMS



CLIP CIELO



CLIP CORAL



CLIP MARE



CLIP COCO

GLOSS
FINISH

BABY ROOMS | HABITACIONES INFANTILES

CHAMBRES DE BÉBÉ | *BABYZIMMER* | CAMERETTE PER BAMBINI

Wardrobes | Armarios | Armoires | *Schränke* | Armadi

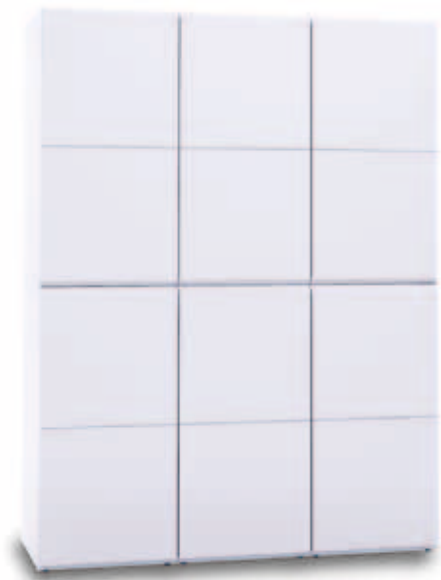

A3016

↑ 200 cm → 150 cm ↻ 58,8 cm

📐 A3016-G2300

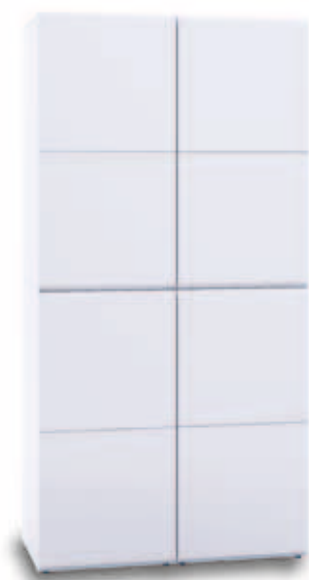

A3014

↑ 200 cm → 100 cm ↻ 58,8 cm

📐 A3014-G2300

Chests | Cómodas | Commodes
Kommoden | Cassettiere



D20132

↑ 91 cm → 141 cm ↻ 48,8 cm

📐 D20132-G2300



D20121

↑ 91 cm → 94 cm ↻ 48,8 cm

📐 D20121-G2300



V656-G2300

Optional changer support
Soporte vestidor opcional
Plan à langer supplémentaire
Zusätzlicher Wickelaufsatz
Supporto fasciatoio supplementare

60 x 120 cm

Cots | Cunas | Lits bébé | *Babybetten* | Lettini



Cot 60x120 | *Cuna 60x120* | Lit bébé 60x120
Babybett 60x120 | Lettino 60x120

C150

↑ 80 cm → 132 cm ↻ 64 cm

📐 C150-G2300

70 x 140 cm

Cots | Cunas | Lits bébé | *Babybetten* | Lettini



Cot 70x140 | *Cuna 70x140* | Lit bébé 70x140
Babybett 70x140 | Lettino 70x140

C160

↑ 79,5 cm → 150 cm ↻ 74,1 cm

📐 C160-G2300



Toddler bed | *Cama infantil* | Lit cadet
Kinderbett | Letto

Bath changers | Bañeras

Baignoires | *Waschtische* | Bagnetti



B706

↑ 91 cm → 94 cm ↻ 48,8 cm

📐 B706-G2300

MODULAR

BABY ROOMS

GLOSS
FINISH



D20132-G2300



A3016-G2300



C150-G2300
60x120 cm

MODULAR ARTIK

BABY FURNITURE

GLOSS
FINISH

BABY ROOMS | HABITACIONES INFANTILES

CHAMBRES DE BÉBÉ | *BABYZIMMER* | CAMERETTE PER BAMBINI

Wardrobes | Armarios | Armoires | *Schränke* | Armadi



A3016

↑ 200 cm → 150 cm ↻ 58,8 cm

■ A3016-G2335



A3014

↑ 200 cm → 100 cm ↻ 58,8 cm

■ A3014-G2335

Chests | Cómodas | Commodes
Kommoden | Cassettiere



D20132

↑ 91 cm → 141 cm ↻ 48,8 cm

■ D20132-G2335



D20121

↑ 91 cm → 94 cm ↻ 48,8 cm

■ D20121-G2335



V656-G2300

Optional changer support
Soporte vestidor opcional
Plan à langer supplémentaire
Zusätzlicher Wickelaufsatz
Supporto fasciatoio supplementare

60 x 120 cm

Cots | Cunas | Lits bébé | *Babybetten* | Lettini



Cot 60x120 | Cuna 60x120 | Lit bébé 60x120
Babybett 60x120 | Lettino 60x120

C150

↑ 80 cm → 132 cm ↻ 64 cm

■ C150-G2335

70 x 140 cm

Cots | Cunas | Lits bébé | *Babybetten* | Lettini



Cot 70x140 | Cuna 70x140 | Lit bébé 70x140
Babybett 70x140 | Lettino 70x140

C160

↑ 79,5 cm → 150 cm ↻ 74,1 cm

■ C160-G2335



Toddler bed | Cama infantil | Lit cadet
Kinderbett | Letto

Bath changers | Bañeras

Baignoires | *Waschtische* | Bagnetti



B706

↑ 91 cm → 94 cm ↻ 48,8 cm

■ B706-G2335

MODULAR

BABY ROOMS

GLOSS
FINISH



D20132-G2335

A3016-G2335

C150-G2335
60x120 cm

MODULAR PEARL

BABY FURNITURE

Wardrobes | Armarios | Armoires | Schränke | Armadi

Chests | Cómodos | Commodes | Kommoden | Cassettiere



V657-M7700

Optional changer support
 Soporte vestidor opcional
 Plan à langer supplémentaire
 Zusätzlicher Wickelaufsatz
 Supporto fasciatoio supplementare

A354G

↑ 204,8 cm → 120 cm ↻ 61,6 cm

-  A354G-M7700
-  A354G-M7751
-  A354G-M7752
-  A354G-M7753
-  A354G-M7778

A354

↑ 204,8 cm → 80 cm ↻ 61,6 cm

-  A354-M7700
-  A354-M7751
-  A354-M7752
-  A354-M7753
-  A354-M7778

D254G

↑ 84,8 cm → 120 cm ↻ 61,6 cm

-  D254G-M7700
-  D254G-M7751
-  D254G-M7752
-  D254G-M7753
-  D254G-M7778

D254C

↑ 84,8 cm → 80 cm ↻ 61,6 cm

-  D254C-M7700
-  D254C-M7751
-  D254C-M7752
-  D254C-M7753
-  D254C-M7778

D254

↑ 84,8 cm → 80 cm ↻ 61,6 cm

-  D254-M7700
-  D254-M7751
-  D254-M7752
-  D254-M7753
-  D254-M7778

60 x 120 cm
Cots | Cunas | Lits bébé | Babybetten | Lettini



70 x 140 cm
Cots | Cunas | Lits bébé | Babybetten | Lettini



Bath changers | Bañeras
 Baignoires | *Waschtische* | Bagnetti



Cot 60x120 | Cuna 60x120 | Lit bébé 60x120
Babybett 60x120 | Lettino 60x120

C150

↑ 80 cm → 132 cm ↻ 64 cm

-  C150-M7700
-  C150-M7751
-  C150-M7752
-  C150-M7753
-  C150-M7778

Cot 70x140 | Cuna 70x140 | Lit bébé 70x140
Babybett 70x140 | Lettino 70x140

C160

↑ 79,5 cm → 150 cm ↻ 74,1 cm

-  C160-M7700
-  C160-M7751
-  C160-M7752
-  C160-M7753
-  C160-M7778

Toddler bed | Cama infantil | Lit cadet
Kinderbett | Letto

B754

↑ 93 cm → 79 cm ↻ 49 cm

-  B754-M7700
-  B754-M7751
-  B754-M7752
-  B754-M7753
-  B754-M7778

BUBBLE

BABY ROOMS

MATTE
FINISH

BUBBLE GREY



BABY FURNITURE



BUBBLE **WHITE**



BUBBLE **CIELO**



BUBBLE **CORAL**



BUBBLE **GREY**

BUBBLE ARENA

MATTE
FINISH

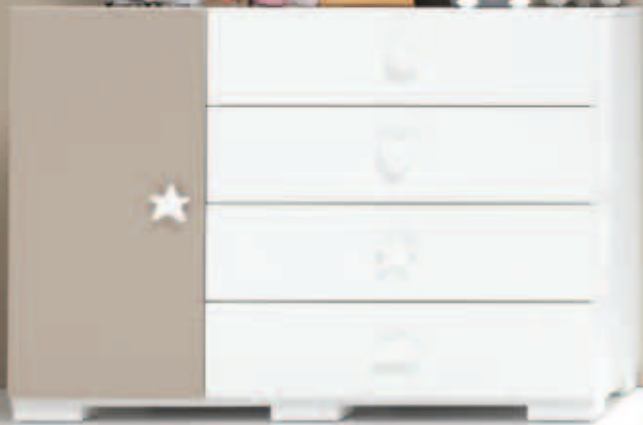

D254G-M7753



C150-M7753
60 x 120 cm



A354G-M7753



BABY FURNITURE

MATTE
FINISH

BABY ROOMS | HABITACIONES INFANTILES

CHAMBRES DE BÉBÉ | *BABYZIMMER* | CAMERETTE PER BAMBINI

Wardrobes | Armarios | Armoires | *Schränke* | Armadi



Close-up of the feet
Detalle de la pata del mueble
Vue rapprochée du pied
Detailansicht der Möbelfüße
Particolare del piedino del mobile

A336

↑ 202,2 cm → 108,2 cm ↻ 61,8 cm

- A336-M7700
- A336-M7751
- A336-M7752
- A336-M7753
- A336-M7778
- A336-M7781

Chests | Cómicas | Commodes | *Kommoden* | Cassettiere



V657-M7700

Optional changer support
Soporte vestidor opcional
Plan à langer supplémentaire
Zusätzlicher Wickelaufsatz
Supporto fasciatoio supplementare



D236

↑ 95 cm → 108,2 cm ↻ 51,5 cm

- D236-M7700
- D236-M7751
- D236-M7752
- D236-M7753
- D236-M7778
- D236-M7781

60 x 120 cm

Cots | Cunas | Lits bébé | *Babybetten* | Lettini



Cot 60x120 | Cuna 60x120 | Lit bébé 60x120
Babybett 60x120 | Lettino 60x120

C150

↑ 80 cm → 132 cm ↻ 64 cm

- C150-M7700
- C150-M7751
- C150-M7752
- C150-M7753
- C150-M7778
- C150-M7781

70 x 140 cm

Cots | Cunas | Lits bébé | *Babybetten* | Lettini



Cot 70x140 | Cuna 70x140 | Lit bébé 70x140
Babybett 70x140 | Lettino 70x140

C160

↑ 79,5 cm → 150 cm ↻ 74,1 cm

- C160-M7700
- C160-M7751
- C160-M7752
- C160-M7753
- C160-M7778
- C160-M7781



Toddler bed | Cama infantil | Lit cadet
Kinderbett | Letto

MATTE
FINISH



D236-M7751



C150-M7751
60x120 cm



A336-M7751

EVEN CIELO

BABY FURNITURE



EVERN **WHITE**



EVERN **CORAL**



EVERN **ARENA**



EVERN **MARE**

EVEN GREY

MATTE
FINISH



D236-M7778



A336-M7778



C150-M7778
60x120cm

BABY FURNITURE

BABY ROOMS | HABITACIONES INFANTILES
CHAMBRES DE BÉBÉ | *BABYZIMMER* | CAMERETTE PER BAMBINI

Wardrobes | Armarios | Armoires | Schränke | Armadi



A317

↑ 199,5 cm → 109,8 cm ↻ 60 cm

▫ A317-M7700

▫ A317-M7778



A317P / A317PL

↑ 201,5 cm → 109,8 cm ↻ 60 cm

▫ A317P-M7791

▫ A317P-M7792

▫ A317PL-M7700

▫ A317PL-M7778

Chests | Cómodas | Commodes | Kommoden | Cassettiere



D217

↑ 84 cm → 109,9 cm ↻ 49,5 cm

▫ D217-M7700

▫ D217-M7778



D217P / D217PL

↑ 90 cm → 109,9 cm ↻ 49,5 cm

▫ D217P-M7791

▫ D217P-M7792

▫ D217PL-M7700

▫ D217PL-M7778



V656-M7700

Optional changer support
Soporte vestidor opcional
Plan à langer supplémentaire
Zusätzlicher Wickelaufsatz
Supporto fasciatoio supplementare

70 x 140 cm

Cots | Cunas | Lits bébé | Babybetten | Lettini



C137

▫ C137-M7700

▫ C137-M7778



C137P / C137PL

▫ C137P-M7791

▫ C137P-M7792

▫ C137PL-M7700

▫ C137PL-M7778

Cot 70x140 | Cuna 70x140 | Lit bébé 70x140
Babybett 70x140 | Lettino 70x140

↑ 86,4 cm → 146 cm ↻ 80 cm

Toddler bed | Cama infantil | Lit cadet
Kinderbett | Letto

↑ 75,9 cm → 146 cm ↻ 80 cm

Desk | Escritorio | Bureau
Schreibtisch | Scrivania

↑ 74,6 cm → 146 cm ↻ 80 cm

PREMIUM **KURVE**

BABY ROOMS

MATTE
FINISH



A317P-M7791



C137P-M7791
70x140 cm

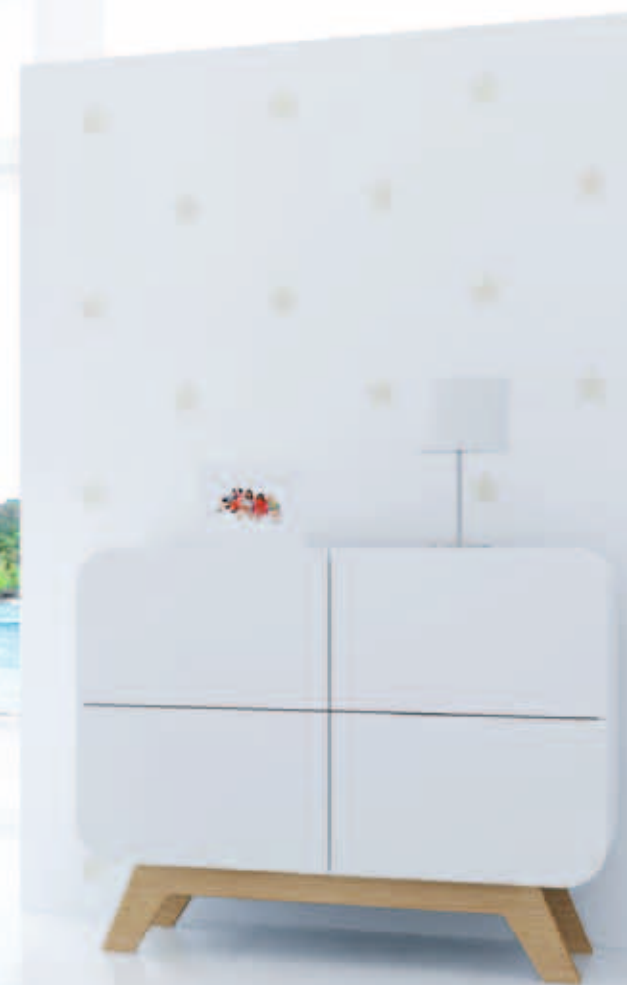

D217P-M7791

KURVE ESSENCE **NATURE**

BABY FURNITURE



C137-M7700
70x 140cm

A317-M7700

D217-M7700

KURVE **WHITE**



D217PL-M7700

C137PL-M7700
70x 140cm

A317PL-M7700

KURVE ESSENCE **WHITE**



A317PL-M7778

C137PL-M7778
70x 140cm

D217PL-M7778

KURVE ESSENCE **GREY**



C137P-M7792
70x 140cm

A317P-M7792

D217P-M7792

KURVE ESSENCE **COCO**

KURVE GREY

MATTE
FINISH



BABY FURNITURE





BABY ROOMS | HABITACIONES INFANTILES
CHAMBRES DE BÉBÉ | *BABYZIMMER* | CAMERETTE PER BAMBINI

Wardrobes | Armarios | Armoires | Schränke | Armadi



A359G

↑ 204,8 cm → 120 cm ↻ 61,6 cm

-  A359G-M7700
-  A359G-M7778
-  A359G-M7779
-  A359G-M7781
-  A359G-M7782

A359

↑ 204,8 cm → 80 cm ↻ 61,6 cm

-  A359-M7700
-  A359-M7778
-  A359-M7779
-  A359-M7781
-  A359-M7782

Chests | Cómodas | Commodes | Kommoden | Cassettiere





D259G

↑ 84,8 cm → 120 cm ↻ 61,6 cm

-  D259G-M7700
-  D259G-M7778
-  D259G-M7779
-  D259G-M7781
-  D259G-M7782



D259C

↑ 84,8 cm → 80 cm ↻ 61,6 cm

-  D259C-M7700
-  D259C-M7778
-  D259C-M7779
-  D259C-M7781
-  D259C-M7782

D259

↑ 84,8 cm → 80 cm ↻ 61,6 cm

-  D259-M7700
-  D259-M7778
-  D259-M7779
-  D259-M7781
-  D259-M7782



Optional changer support
Soporte vestidor opcional
Plan à langer supplémentaire
Zusätzlicher Wickelaufsatz
Supporto fasciatoio supplementare





60 x 120 cm
Cots | Cunas | Lits bébé | *Babybetten* | Lettini



Cot 60x120 | Cuna 60x120 | Lit bébé 60x120
Babybett 60x120 | Lettino 60x120

C150

↑ 80 cm → 132 cm ↻ 64 cm

-  C150-M7700
-  C150-M7778
-  C150-M7779
-  C150-M7781
-  C150-M7782

70 x 140 cm
Cots | Cunas | Lits bébé | *Babybetten* | Lettini



Cot 70x140 | Cuna 70x140 | Lit bébé 70x140
Babybett 70x140 | Lettino 70x140

C160

↑ 79,5 cm → 150 cm ↻ 74,1 cm

-  C160-M7700
-  C160-M7778
-  C160-M7779
-  C160-M7781
-  C160-M7782







Toddler bed | Cama infantil | Lit cadet
Kinderbett | Letto

Bath changers | Bañeras
Baignoires | *Waschtische* | Bagnetti



B759

↑ 93 cm → 79 cm ↻ 49 cm

-  B759-M7700
-  B759-M7778
-  B759-M7779
-  B759-M7781
-  B759-M7782

JOY

BABY ROOMS

MATTE
FINISH



JOY **ROSE**

BABY FURNITURE



JOY WHITE



JOY GREY



JOY ETNIK



JOY ROSE

JOY MARE

MATTE
FINISH



A359G-M7781

C150-M7781
60x120 cm



D259-M7781

BABY FURNITURE



BUBBLE **WHITE**



BUBBLE **CIELO**



BUBBLE **ARENA**



BUBBLE **GREY**

B754



93 x 79 x 49 cm

C150



80 x 132 x 64 cm



Close-up of hidden wheel
 Detalle de la rueda oculta de la cuna
 Détail de la roue cachée du lit bébé
 Detallsicht des versteckten Rades
 Particolare della ruota nascosta del lettino

BUBBLE

COTS & BATHS

MATTE
FINISH

633-112



93 x 79 x 49 cm



B754-M7752



BUBBLE CORAL



80 x 132 x 64 cm



C150-M7752

60 x 120 cm

BABY FURNITURE

2 COLOURS | 2 COLORES | 2 COULEURS | 2 FARBEN | 2 COLORI

GLOSS
FINISH



633-140

B706-G2335

C150-G2335

60 x 120 cm

MODULAR PEARL

B706



93 x 79 x 49 cm

C150



80 x 132 x 64 cm



Close-up of hidden wheel

Détail de la rueda oculta de la cuna

Détail de la roue cachée du lit bébé

Detailansicht des versteckten Rades

Particolare della ruota nascosta del lettino

MODULAR

COTS & BATHS

COTS AND BATH CHANGERS | CUNAS Y BAÑERAS
LITS BÉBÉ ET BAIGNOIRES | BABYBETTEN UND WASCHTISCHE | LETTINI E BAGNETTI

GLOSS
FINISH



633-178



93 x 79 x 49 cm



B706-G2300



80 x 132 x 64 cm



C150-G2300

60 x 120 cm

MODULAR ARTIK

BABY FURNITURE



JOY WHITE



JOY GREY



JOY MARE



JOY ROSE

B759



93 x 79 x 49 cm

C150



80 x 132 x 64 cm



Close-up of hidden wheel

Détail de la rueda oculta de la cuna

Détail de la roue cachée du lit bébé

Detailansicht des versteckten Rades

Particolare della ruota nascosta del lettino

JOY

COTS & BATHS

COTS AND BATH CHANGERS | CUNAS Y BAÑERAS
LITS BÉBÉ ET BAIGNOIRES | BABYBETTEN UND WASCHTISCHE | LETTINI E BAGNETTI

MATTE
FINISH

633-179

80 x 132 x 64 cm



C150-M7779
60 x 120 cm

B759-M7779

93 x 79 x 49 cm



JOY **ETNIK**

BABY FURNITURE



Number of pieces
Número de piezas
Nombre de pièces
Anzahl der Teile
Numero di pezzi

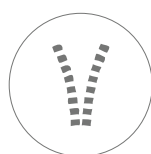

Removable without zipper
Desenfundable sin cremallera
Déhoussable sans fermeture éclair
Abziehbar ohne Reißverschluss
Sfoderabile senza chiusura zip



Double-sided for winter & summer
Doble cara. Invierno-verano
Double face hiver-été
Winter- und Sommerseite
Double face inverno-estate



Removable with zipper
Desenfundable con cierre de cremallera
Déhoussable avec fermeture éclair
Abziehbar mit Reißverschluss
Sfoderabile con chiusura zip

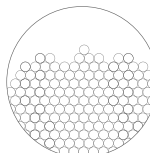

Polystyrene beads filling
Relleno con perlas de poliestireno
Rembourrage billes de polystyrène
Füllung aus Polystyrenkugeln
Imbottito con perle di polistirolo



Number of pennants
Número de banderines
Nombre de banderoles
Anzahl der Wimpel
Numero di bandierine



Velcro closure
Cierre con velcro
Fermeture en scratch
Klettverschluss
Chiusura velcro

631-178
15 x 60 x 90 cm

Top changer for Konver 70x140 and chest
Vestidor para Konver 70x140 y cómoda
Matelas à langer pour Konver 70x140 et commode
Wickelaufgabe für Konver 70x140 und Kommode
Fasciatoio Konver 70x140 e cassetiera



633-178
82 x 10 x 51 cm

Bath changer cover without foam
Funda vestidor sin espuma para bañeras
Housse supplémentaire sans mousse pour baignoires
Bezug für Wickelaufgabe ohne Schaumstoff für Waschtisch
Fodera fasciatoio (senza materassino) per bagnetti



634-178
65 x 8 x 46 cm

Top changer for Konver 60x120 and Twins
Vestidor para Konver 60x120 y Twins
Matelas à langer pour Konver 60x120 et Twins
Wickelaufgabe für Konver 60x120 und Twins
Fasciatoio Konver 60x120 e Twins



* Inside foam ref. R-VE1 not included | Espuma interior Ref. R-VE1, no incluida
Mousse intérieure Réf. R-VE1 pas incluse | *Wickelaufgabe Ref. R-VE1 nicht inklusive*
Materassino Rif. R-VE1, non incluso

Ref. A0631-B
Towelling liner for 631 | Recambio rizo para 631
Serviette pour réf. 631 | *Frotteebezug für 631* | Ricambio fasciatoio Rif. 631

Ref. A0633-B
Towelling liner for 633 | Recambio rizo para 633
Serviette pour réf. 633 | *Frotteebezug für 633* | Ricambio fasciatoio Rif. 633

Ref. A0634-B
Towelling liner for 634 | Recambio rizo para 634
Serviette pour réf. 634 | *Frotteebezug für 634* | Ricambio fasciatoio Rif. 634

670-178
67 x 94 x 65 cm

Crib (colour 23 white gloss)
Minicuna (color 23 blanco brillo)
Berceau (couleur 23 blanc brillant)
Wiege (Farbe 23 glänzendes Weiss)
Culla (colore 23 bianco lucido)



646-178
115 x 115 x 132 cm

Kids tepee tent
Tipi infantil
Tipi enfant
Tipi- Kinderzelt
Tenda indiana



647-178
115 x 115 cm

Carpet for tepee tent
Alfombra para Tipi infantil
Tapis pour tipi
Teppich für Tipi- Kinderzelt
Tappeto per tenda indiana



CAREZZA 178

COLLECTION

TEXTILES | TEXTILES | LAYETTE | TEXTILIEN | TESSILE



TEXTILES

618-178

21 x 30 x 20 cm

Padded baby toiletries basket

Cesta colonias infantil acolchada

Panier matelassé pour produits de soin

Gefütterter Stoffkorb für Badeartikel

Cestino portasaponi trapuntato



619-178

41 x 34 x 34 cm

Padded fabric storage basket

Saco de juguetes textil acolchado

Panier de rangement matelassé

Gefütterter Korb für Spielwaren

Sacco portagiochi trapuntato



690G-178

35 x 35 x 15 cm

Square cushion with removable cover

Cojin infantil cuadrado desenfundable

Coussin carré déhoussable

Quadratisches Kissen (abziehbar)

Cuscino quadrato sfoderabile



693-178

☆ 34 x 34 x 10 cm

♡ 20 x 20 x 8 cm

☾ 26 x 20 x 8 cm

Set 3 decorative cushions

Set 3 cojines infantiles decoración

Set 3 coussins décoratifs

Set 3 Dekokissen

Set 3 cuscini da decorazione



694-178

▼ 18 x 12 cm

Garland-pennants (2,50 m long)

Guiraldas-banderines infantiles (2,50 m largo)

Guirlande-banderole (2,50 m longueur)

Stoff-Girlande (2,50 m lang)

Ghirlanda-bandierine (2,50 m. lunghezza)



689-178

36 x 43 x 12 cm

Kids cushion · Mountains

Cojin infantil · Montañas

Coussin enfant · Montagnes

Kinder-Kissen · Berge

Cuscino decorativo · Montagna



691-178

32 x 36 x 10 cm

Kids cushion · Teepee tent

Cojin infantil · Tipi

Coussin enfant · Tipi

Kinder-Kissen · Tipi

Cuscino decorativo · Tenda



692L-900

35 x 43 x 11 cm

Kids cushion · Triangle

Cojin infantil · Triángulo

Coussin enfant · Triangle

Kinder-Kissen · Dreieck

Cuscino decorativo · Triangolo



692G-178

35 x 43 x 11 cm

Kids cushion · Triangle

Cojin infantil · Triángulo

Coussin enfant · Triangle

Kinder-Kissen · Dreieck

Cuscino decorativo · Triangolo



CAREZZA 178

COLLECTION

60x120

612-178

110 x 150 cm

Cot sheets set - 3 pieces (100% Cotton)
Sábanas cuna - 3 piezas (100% Algodón)
 Parure de lit - 3 pièces (100% Coton)
 Bettwäsche - 3 tlg. (100% Baumwolle)
 Lenzuola lettino - 3 pezzi (100% Cotone)

Set
3
pieces

70x140

632-178

135 x 175 cm

616-178

95 x 122 cm

Crib sheets set - 3 pieces (100% Cotton)
Sábanas minicuna - 3 piezas (100% Algodón)
 Parure de berceau - 3 pièces (100% Coton)
 Bettwäsche für Wiege 3-tlg. (100% Baumwolle)
 Lenzuola culla - 3 pezzi (100% Cotone)



698-178

26 x 29 x 18 cm

26 x 42 x 18 cm

Sleep positioner with removable cover
Cojín Antivelcro bebé desenfundable
 Cale-bébé déhoussable
 Seitenschläferkissen (abziehbar)
 Riduttore dormisicuro sfoderabile



60x120

606-178

90 x 123 cm

Duvet cover (with duvet)
Nórdico (con relleno)
 Housse et couette
 Bettbezug (mit Decke)
 Piumino nordico (con imbottitura)



70x140

626-178

105 x 143 cm

60x120

606F-178

90 x 123 cm

Duvet cover (without duvet)
Funda nórdica (sin relleno)
 Housse pour couette
 Bettbezug (ohne Decke)
 Copripiumino nordico (senza imbottitura)

70x140

626F-178

105 x 143 cm

60x120

607-178

180 x 44 cm

Bumper Protector
 Tour de lit
 Nestchen
 Paracolpi

70x140

627-178

210 x 44 cm



60x120

9L2N-178

Bumper + Duvet cover (with duvet) | Protector + Nórdico (con relleno)
 Tour de lit + Housse et couette | Nestchen + Bettbezug (mit Decke)
 Paracolpi + Piumino nordico (con imbottitura)

70x140

9L2NG-178

TEXTILES

631-153

15 x 60 x 90 cm



Top changer for Konver 70x140 and chest
Vestidor para Konver 70x140 y cómoda
 Matelas à langer pour Konver 70x140 et commode
 Wickelaufgabe für Konver 70x140 und Kommode
 Fasciatoio Konver 70x140 e cassetiera



633-153

82 x 10 x 51 cm



Bath changer cover without foam
Funda vestidor sin espuma para bañeras
 Housse supplémentaire sans mousse pour baignoires
 Bezug für Wickelaufgabe ohne Schaumstoff für Waschtisch
 Fodera fasciatoio (senza materassino) per bagnetti



634-153

65 x 8 x 46 cm



Top changer for Konver 60x120 and Twins
Vestidor para Konver 60x120 y Twins
 Matelas à langer pour Konver 60x120 et Twins
 Wickelaufgabe für Konver 60x120 und Twins
 Fasciatoio Konver 60x120 e Twins



* Inside foam ref. R-VE1 not included | Espuma interior Ref. R-VE1, no incluida
 Mousse intérieure Ref. R-VE1 pas incluse | Wickelaufgabe Ref. R-VE1 nicht inklusive
 Materassino Rif. R-VE1, non incluso

Ref. A0631-B

Towelling liner for 631 | Recambio rizo para 631

Serviette pour réf. 631 | Frotteebezug für 631 | Ricambio fasciatoio Rif. 631

Ref. A0633-B

Towelling liner for 633 | Recambio rizo para 633

Serviette pour réf. 633 | Frotteebezug für 633 | Ricambio fasciatoio Rif. 633

Ref. A0634-B

Towelling liner for 634 | Recambio rizo para 634

Serviette pour réf. 634 | Frotteebezug für 634 | Ricambio fasciatoio Rif. 634

670-153

67 x 94 x 65 cm



Crib (colour 23 white gloss)
Minicuna (color 23 blanco brillo)
 Berceau (couleur 23 blanc brillant)
 Wiege (Farbe 23 glänzendes Weiss)
 Culla (colore 23 bianco lucido)



646-153

115 x 115 x 132 cm

Kids tepee tent
Tipi infantil
 Tipi enfant
 Tipi- Kinderzelt
 Tenda indiana



647-153

115 x 115 cm

Carpet for tepee tent
Alfombra para Tipi infantil
 Tapis pour tipi
 Teppich für Tipi- Kinderzelt
 Tappeto per tenda indiana



TEXTILES | TEXTILES | LAYETTE | TEXTILIEN | TESSILE

ARENA 153

COLLECTION



TEXTILES

618-153

21 x 30 x 20 cm

Padded baby toiletries basket
Cesta colonias infantil acolchada

Panier matelassé pour produits de soin
Gefütterter Stoffkorb für Badeartikel
Cestino portasaponi trapuntato



619-153

41 x 34 x 34 cm

Padded fabric storage basket
Saco de juguetes textil acolchado

Panier de rangement matelassé
Gefütterter Korb für Spielwaren
Sacco portagiochi trapuntato



690G-153

35 x 35 x 15 cm

Square cushion with removable cover
Cojín infantil cuadrado desfundable

Coussin carré déhoussable
Quadratisches Kissen (abziehbar)
Cuscino quadrato sfoderabile



693-153

☆ 34 x 34 x 10 cm

♡ 20 x 20 x 8 cm

☾ 26 x 20 x 8 cm

Set 3 decorative cushions
Set 3 cojines infantiles decoración

Set 3 coussins décoratifs
Set 3 Dekokissen
Set 3 cuscini da decorazione



694-153

▼ 18 x 12 cm

Garland-pennants (2,50 m long)
Guiraldas-banderines infantiles (2,50 m largo)

Guirlande-banderole (2,50 m longueur)
Stoff-Girlande (2,50 m lang)
Ghirlanda-bandierine (2,50 m. lunghezza)



689-153

36 x 43 x 12 cm

Kids cushion · Mountains
Cojín infantil · Montañas

Coussin enfant · Montagnes
Kinder-Kissen · Berge
Cuscino decorativo · Montagna



691-153

32 x 36 x 10 cm

Kids cushion · Teepee tent
Cojín infantil · Tipi

Coussin enfant · Tipi
Kinder-Kissen · Tipi
Cuscino decorativo · Tenda



692L-900

35 x 43 x 11 cm

Kids cushion · Triangle
Cojín infantil · Triángulo

Coussin enfant · Triangle
Kinder-Kissen · Dreieck
Cuscino decorativo · Triangolo



692G-153

35 x 43 x 11 cm

Kids cushion · Triangle
Cojín infantil · Triángulo

Coussin enfant · Triangle
Kinder-Kissen · Dreieck
Cuscino decorativo · Triangolo



ARENA 153

COLLECTION

60x120

612-153

110 x 150 cm

Cot sheets set - 3 pieces (100% Cotton)

Sábanas cuna - 3 piezas (100% Algodón)

Parure de lit - 3 pièces (100% Coton)

Bettwäsche - 3 tlg. (100% Baumwolle)

Lenzuola lettino - 3 pezzi (100% Cotone)

Set
3
pièces

70x140

632-153

135 x 175 cm

616-153

95 x 122 cm

Crib sheets set - 3 pieces (100% Cotton)

Sábanas minicuna - 3 piezas (100% Algodón)

Parure de berceau - 3 pièces (100% Coton)

Bettwäsche für Wiege 3-tlg. (100% Baumwolle)

Lenzuola culla - 3 pezzi (100% Cotone)



698-153

26 x 29 x 18 cm

26 x 42 x 18 cm

Sleep positioner with removable cover

Cojín Antivuelco bebé desenfundable

Cale-bébé déhoussable

Seitenschläferkissen (abziehbar)

Riduttore dormisicuro sfoderabile



60x120

606-153

90 x 123 cm

Duvet cover (with duvet)

Nórdico (con relleno)

Housse et couette

Bettbezug (mit Decke)

Plumino nordico (con imbottitura)



70x140

626-153

105 x 143 cm

60x120

606F-153

90 x 123 cm

Duvet cover (without duvet)

Funda nórdica (sin relleno)

Housse pour couette

Bettbezug (ohne Decke)

Copriplumino nordico (senza imbottitura)

70x140

626F-153

105 x 143 cm



60x120

607-153

180 x 44 cm

Bumper

Protector

Tour de lit

Nestchen

Paracolpi

70x140

627-153

210 x 44 cm



60x120

9L2N-153

Bumper + Duvet cover (with duvet) | Protector + Nórdico (con relleno)

Tour de lit + Housse et couette | *Nestchen + Bettbezug (mit Decke)*

Paracolpi + Plumino nordico (con imbottitura)

70x140

9L2NG-153

TEXTILES

631-140
15 x 60 x 90 cm

Top changer for Konver 70x140 and chest
Vestidor para Konver 70x140 y cómoda
Matelas à langer pour Konver 70x140 et commode
Wickelaufgabe für Konver 70x140 und Kommode
Fasciatoio Konver 70x140 e cassetiera



633-140
82 x 10 x 51 cm

Bath changer cover without foam
Funda vestidor sin espuma para bañeras
Housse supplémentaire sans mousse pour baignoires
Bezug für Wickelaufgabe ohne Schaumstoff für Waschtisch
Fodera fasciatoio (senza materassino) per bagnetti



634-140
65 x 8 x 46 cm

Top changer for Konver 60x120 and Twins
Vestidor para Konver 60x120 y Twins
Matelas à langer pour Konver 60x120 et Twins
Wickelaufgabe für Konver 60x120 und Twins
Fasciatoio Konver 60x120 e Twins

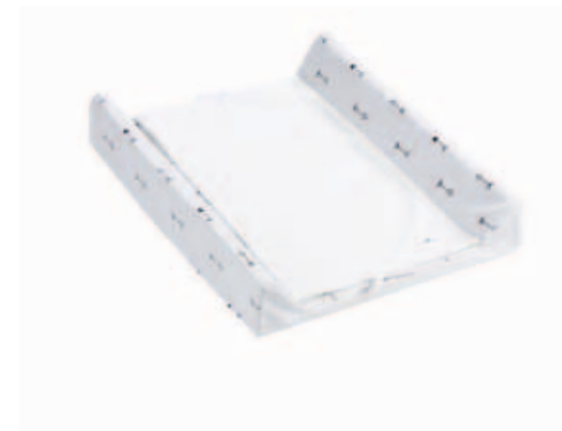

* Inside foam ref. R-VE1 not included | Espuma interior Ref. R-VE1, no incluida
Mousse intérieure Réf. R-VE1 pas incluse | Wickelaufgabe Ref. R-VE1 nicht inklusive
Materassino Rif. R-VE1, non incluso

Ref. A0631-B
Towelling liner for 631 | Recambio rizo para 631
Serviette pour réf. 631 | Frotteebezug für 631 | Ricambio fasciatoio Rif. 631

Ref. A0633-B
Towelling liner for 633 | Recambio rizo para 633
Serviette pour réf. 633 | Frotteebezug für 633 | Ricambio fasciatoio Rif. 633

Ref. A0634-B
Towelling liner for 634 | Recambio rizo para 634
Serviette pour réf. 634 | Frotteebezug für 634 | Ricambio fasciatoio Rif. 634

670-140
67 x 94 x 65 cm

Crib (colour 23 white gloss)
Minicuna (color 23 blanco brillo)
Berceau (couleur 23 blanc brillant)
Wiege (Farbe 23 glänzendes Weiss)
Culla (colore 23 bianco lucido)

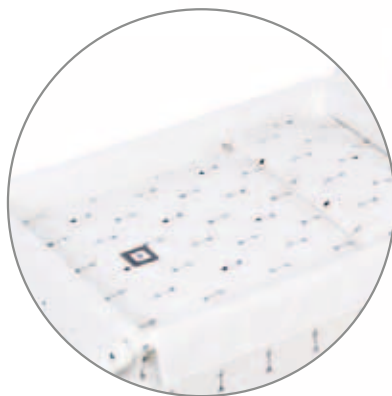

646-140
115 x 115 x 132 cm

Kids tepee tent
Tipi infantil
Tipi enfant
Tipi- Kinderzelt
Tenda indiana



647-140
115 x 115 cm

Carpet for tepee tent
Alfombra para Tipi infantil
Tapis pour tipi
Teppich für Tipi- Kinderzelt
Tappeto per tenda indiana



ARROW 140

COLLECTION

TEXTILES | TEXTILES | LAYETTE | TEXTILIEN | TESSILE



TEXTILES

618-140

21 x 30 x 20 cm

Padded baby toiletries basket
Cesta colonias infantil acolchada

Panier matelassé pour produits de soin
Gefütterter Stoffkorb für Badeartikel
Cestino portasaponi trapuntato



619-140

41 x 34 x 34 cm

Padded fabric storage basket
Saco de juguetes textil acolchado

Panier de rangement matelassé
Gefütterter Korb für Spielwaren
Sacco portagiochi trapuntato



694-140

18 x 12 cm

Garland-pennants (2,50 m long)
Guiraldas-banderines infantiles (2,50 m largo)

Guirlande-banderole (2,50 m longueur)
Stoff-Girlande (2,50 m lang)
Ghirlanda-bandierine (2,50 m. lunghezza)

x16



690E-140

35 x 35 x 15 cm

Square cushion with removable cover
Cojín infantil cuadrado desenfundable

Coussin carré déhoussable
Quadratisches Kissen (abziehbar)
Cuscino quadrato sfoderabile



690L-140

35 x 35 x 15 cm

Square cushion with removable cover
Cojín infantil cuadrado desenfundable

Coussin carré déhoussable
Quadratisches Kissen (abziehbar)
Cuscino quadrato sfoderabile



693-140

☆ 34 x 34 x 10 cm

♡ 20 x 20 x 8 cm

☾ 26 x 20 x 8 cm

Set 3 decorative cushions
Set 3 cojines infantiles decoración

Set 3 coussins décoratifs
Set 3 Dekokissen
Set 3 cuscini da decorazione

Set
3
pieces



689-140

36 x 43 x 12 cm

Kids cushion · Mountains
Cojín infantil · Montañas

Coussin enfant · Montagnes
Kinder-Kissen · Berge
Cuscino decorativo · Montagna



691-140

32 x 36 x 10 cm

Kids cushion · Teepee tent
Cojín infantil · Tipi

Coussin enfant · Tipi
Kinder-Kissen · Tipi
Cuscino decorativo · Tenda



692E-140

35 x 43 x 11 cm

Kids cushion · Triangle
Cojín infantil · Triángulo

Coussin enfant · Triangle
Kinder-Kissen · Dreieck
Cuscino decorativo · Triangolo



692L-140

35 x 43 x 11 cm

Kids cushion · Triangle
Cojín infantil · Triángulo

Coussin enfant · Triangle
Kinder-Kissen · Dreieck
Cuscino decorativo · Triangolo



ARROW 140

COLLECTION

697C-140

15 x 114 x 58 cm

Large pregnancy pillow (cover + pad)

Cojín de maternidad (funda + relleno)

Coussin de maternité (housse + garnissage)

Schwangerschaftskissen (Bezug + Füllung)

Cuscino premaman grande (fodera + imbottitura)



696-140

15 x 55 x 50 cm

Nursing pillow with removable cover (cover + pad)

Cojín de lactancia desenfundable (funda + relleno)

Coussin d'allaitement déhoussable (housse + garnissage)

Stillkissen · abziehbar (Bezug + Füllung)

Cuscino allattamento sfoderabile (fodera + imbottitura)



60x120

612-140

110 x 150 cm

70x140

632-140

135 x 175 cm

Cot sheets set - 3 pieces (100% Cotton)

Sábanas cuna - 3 piezas (100% Algodón)

Parure de lit - 3 pièces (100% Coton)

Bettwäsche - 3 tlg. (100% Baumwolle)

Lenzuola lettino - 3 pezzi (100% Cotone)

616-140

95 x 122 cm

Crib sheets set - 3 pieces (100% Cotton)

Sábanas minicuna - 3 piezas (100% Algodón)

Parure de berceau - 3 pièces (100% Coton)

Bettwäsche für Wiege 3-tlg. (100% Baumwolle)

Lenzuola culla - 3 pezzi (100% Cotone)



698-140

26 x 29 x 18 cm

26 x 42 x 18 cm

Sleep positioner with removable cover

Cojín Antivuelco bebé desenfundable

Cale-bébé déhoussable

Seitenschläferkissen (abziehbar)

Riduttore dormisicuro sfoderabile



60x120

606-140

90 x 123 cm

70x140

626-140

105 x 143 cm

Duvet cover (with duvet)

Nórdico (con relleno)

Housse et couette

Bettbezug (mit Decke)

Piumino nordico (con imbottitura)

60x120

606F-140

90 x 123 cm

70x140

626F-140

105 x 143 cm

Duvet cover (without duvet)

Funda nórdica (sin relleno)

Housse pour couette

Bettbezug (ohne Decke)

Copripiumino nordico (senza imbottitura)



60x120

607-140

180 x 44 cm

70x140

627-140

210 x 44 cm

Bumper

Protector

Tour de lit

Nestchen

Paracolpi



60x120

9L2N-140

70x140

9L2NG-140

Bumper + Duvet cover (with duvet) | Protector + Nórdico (con relleno)

Tour de lit + Housse et couette | Nestchen + Bettbezug (mit Decke)

Paracolpi + Piumino nordico (con imbottitura)

TEXTILES

631-190

15 x 60 x 90 cm



Top changer for Konver 70x140 and chest
Vestidor para Konver 70x140 y cómoda
 Matelas à langer pour Konver 70x140 et commode
 Wickelaufgabe für Konver 70x140 und Kommode
 Fasciatoio Konver 70x140 e cassetiera



633-190

82 x 10 x 51 cm



Bath changer cover without foam
Funda vestidor sin espuma para bañeras
 Housse supplémentaire sans mousse pour baignoires
 Bezug für Wickelaufgabe ohne Schaumstoff für Waschtisch
 Fodera fasciatoio (senza materassino) per bagnetti



634-190

65 x 8 x 46 cm



Top changer for Konver 60x120 and Twins
Vestidor para Konver 60x120 y Twins
 Matelas à langer pour Konver 60x120 et Twins
 Wickelaufgabe für Konver 60x120 und Twins
 Fasciatoio Konver 60x120 e Twins



* Inside foam ref. R-VE1 not included | Espuma interior Ref. R-VE1, no incluida
 Mousse intérieure Ref. R-VE1 pas incluse | Wickelaufgabe Ref. R-VE1 nicht inklusive
 Materassino Rif. R-VE1, non incluso

Ref. A0631-B

Towelling liner for 631 | Recambio rizo para 631
 Serviette pour réf. 631 | Frotteebezug für 631 | Ricambio fasciatoio Rif. 631

Ref. A0633-B

Towelling liner for 633 | Recambio rizo para 633
 Serviette pour réf. 633 | Frotteebezug für 633 | Ricambio fasciatoio Rif. 633

Ref. A0634-B

Towelling liner for 634 | Recambio rizo para 634
 Serviette pour réf. 634 | Frotteebezug für 634 | Ricambio fasciatoio Rif. 634

670-190

67 x 94 x 65 cm



Crib (colour 23 white gloss)
Minicuna (color 23 blanco brillo)
 Berceau (couleur 23 blanc brillant)
 Wiege (Farbe 23 glänzendes Weiss)
 Culla (colore 23 bianco lucido)



TEXTILES | TEXTILES | LAYETTE | TEXTILIEN | TESSILE

DELTA 190

COLLECTION



TEXTILES

618-190

21 x 30 x 20 cm

Padded baby toiletries basket
Cesta colonias infantil acolchada

Panier matelassé pour produits de soin
Gefütterter Stoffkorb für Badeartikel
Cestino portasaponi trapuntato



619-190

41 x 34 x 34 cm

Padded fabric storage basket
Saco de juguetes textil acolchado

Panier de rangement matelassé
Gefütterter Korb für Spielwaren
Sacco portagiochi trapuntato



690A-190

35 x 35 x 15 cm

Square cushion with removable cover
Cojín infantil cuadrado desfundable

Coussin carré déhoussable
Quadratisches Kissen (abziehbar)
Cuscino quadrato sfoderabile



693-190

☆ 34 x 34 x 10 cm

♥ 20 x 20 x 8 cm

☾ 26 x 20 x 8 cm

Set 3 decorative cushions
Set 3 cojines infantiles decoración

Set 3 coussins décoratifs
Set 3 Dekokissen
Set 3 cuscini da decorazione



694-190

▼ 18 x 12 cm

Garland-pennants (2,50 m long)
Guiraldas-banderines infantiles (2,50 m largo)

Guirlande-banderole (2,50 m longueur)
Stoff-Girlande (2,50 m lang)
Ghirlanda-bandierine (2,50 m. lunghezza)



689-914

36 x 43 x 12 cm

Kids cushion · Mountains
Cojín infantil · Montañas

Coussin enfant · Montagnes
Kinder-Kissen · Berge
Cuscino decorativo · Montagna



692A-190

35 x 43 x 11 cm

Kids cushion · Triangle
Cojín infantil · Triángulo

Coussin enfant · Triangle
Kinder-Kissen · Dreieck
Cuscino decorativo · Triangolo



692L-914

35 x 43 x 11 cm

Kids cushion · Triangle
Cojín infantil · Triángulo

Coussin enfant · Triangle
Kinder-Kissen · Dreieck
Cuscino decorativo · Triangolo



DELTA 190

COLLECTION

697C-190

15 x 114 x 58 cm

Large pregnancy pillow (cover + pad)
Cojín de maternidad (funda + relleno)
 Coussin de maternité (housse + garnissage)
 Schwangerschaftskissen (Bezug + Füllung)
 Cuscino premaman grande (fodera + imbottitura)



696-190

15 x 55 x 50 cm

Nursing pillow with removable cover (cover + pad)
Cojín de lactancia desenfundable (funda + relleno)
 Coussin d'allaitement déhoussable (housse + garnissage)
 Stillkissen · abziehbar (Bezug + Füllung)
 Cuscino allattamento sfoderabile (fodera + imbottitura)



60x120

612-190

110 x 150 cm

Cot sheets set - 3 pieces (100% Cotton)
Sábanas cuna - 3 piezas (100% Algodón)
 Parure de lit - 3 pièces (100% Coton)
 Bettwäsche - 3 tlg. (100% Baumwolle)
 Lenzuola lettino - 3 pezzi (100% Cotone)

70x140

632-190

135 x 175 cm

616-190

95 x 122 cm

Crib sheets set - 3 pieces (100% Cotton)
Sábanas minicuna - 3 piezas (100% Algodón)
 Parure de berceau - 3 pièces (100% Coton)
 Bettwäsche für Wiege 3-tlg. (100% Baumwolle)
 Lenzuola culla - 3 pezzi (100% Cotone)



698-190

26 x 29 x 18 cm

26 x 42 x 18 cm

Sleep positioner with removable cover
Cojín Antivuelco bebé desenfundable
 Cale-bébé déhoussable
 Seitenschläferkissen (abziehbar)
 Riduttore dormisicuro sfoderabile



Set
3
pieces

60x120

606-190

90 x 123 cm

Duvet cover (with duvet)
Nórdico (con relleno)
 Housse et couette
 Bettbezug (mit Decke)
 Piumino nordico (con imbottitura)

70x140

626-190

105 x 143 cm



60x120

606F-190

90 x 123 cm

Duvet cover (without duvet)
Funda nórdica (sin relleno)
 Housse pour couette
 Bettbezug (ohne Decke)
 Copripiumino nordico (senza imbottitura)

70x140

626F-190

105 x 143 cm



60x120

607-190

180 x 44 cm

Bumper Protector
 Tour de lit
 Nestchen
 Paracolpi

70x140

627-190

210 x 44 cm



60x120

9L2N-190

Bumper + Duvet cover (with duvet) | Protector + Nórdico (con relleno)
 Tour de lit + Housse et couette | Nestchen + Bettbezug (mit Decke)
 Paracolpi + Piumino nordico (con imbottitura)

70x140

9L2NG-190

TEXTILES

631-112

15 x 60 x 90 cm



Top changer for Konver 70x140 and chest
Vestidor para Konver 70x140 y cómoda
 Matelas à langer pour Konver 70x140 et commode
 Wickelaufgabe für Konver 70x140 und Kommode
 Fasciatoio Konver 70x140 e cassetiera



633-112

82 x 10 x 51 cm



Bath changer cover without foam
Funda vestidor sin espuma para bañeras
 Housse supplémentaire sans mousse pour baignoires
 Bezug für Wickelaufgabe ohne Schaumstoff für Waschtisch
 Fodera fasciatoio (senza materassino) per bagnetti



634-112

65 x 8 x 46 cm



Top changer for Konver 60x120 and Twins
Vestidor para Konver 60x120 y Twins
 Matelas à langer pour Konver 60x120 et Twins
 Wickelaufgabe für Konver 60x120 und Twins
 Fasciatoio Konver 60x120 e Twins



* Inside foam ref. R-VE1 not included | Espuma interior Ref. R-VE1, no incluida
 Mousse intérieure Ref. R-VE1 pas incluse | Wickelaufgabe Ref. R-VE1 nicht inklusive
 Materassino Rif. R-VE1, non incluso

Ref. A0631-B

Towelling liner for 631 | Recambio rizo para 631

Serviette pour réf. 631 | Frotteebezug für 631 | Ricambio fasciatoio Rif. 631

Ref. A0633-B

Towelling liner for 633 | Recambio rizo para 633

Serviette pour réf. 633 | Frotteebezug für 633 | Ricambio fasciatoio Rif. 633

Ref. A0634-B

Towelling liner for 634 | Recambio rizo para 634

Serviette pour réf. 634 | Frotteebezug für 634 | Ricambio fasciatoio Rif. 634

670-112

67 x 94 x 65 cm



Crib (colour 23 white gloss)
Minicuna (color 23 blanco brillo)
 Berceau (couleur 23 blanc brillant)
 Wiege (Farbe 23 glänzendes Weiss)
 Culla (colore 23 bianco lucido)



646-112

115 x 115 x 132 cm

Kids tepee tent
Tipi infantil
 Tipi enfant
 Tipi- Kinderzelt
 Tenda indiana



647-112

115 x 115 cm

Carpet for tepee tent
Alfombra para Tipi infantil
 Tapis pour tipi
 Teppich für Tipi- Kinderzelt
 Tappeto per tenda indiana



INDIANA ROSA 112

COLLECTION

TEXTILES | TEXTILES | LAYETTE | TEXTILIEN | TESSILE



TEXTILES

618-112

21 x 30 x 20 cm

Padded baby toiletries basket
Cesta colonias infantil acolchada

Panier matelassé pour produits de soin
Gefütterter Stoffkorb für Badeartikel
Cestino portasaponi trapuntato



619-112

41 x 34 x 34 cm

Padded fabric storage basket
Saco de juguetes textil acolchado

Panier de rangement matelassé
Gefütterter Korb für Spielwaren
Sacco portagiochi trapuntato



694-112

18 x 12 cm

Garland-pennants (2,50 m long)
Guiraldas-banderines infantiles (2,50 m largo)

Guirlande-banderole (2,50 m longueur)
Stoff-Girlande (2,50 m lang)
Ghirlanda-bandierine (2,50 m. lunghezza)



690E-112

35 x 35 x 15 cm

Square cushion with removable cover
Cojín infantil cuadrado desenfundable

Coussin carré déhoussable
Quadratisches Kissen (abziehbar)
Cuscino quadrato sfoderabile



690L-112

35 x 35 x 15 cm

Square cushion with removable cover
Cojín infantil cuadrado desenfundable

Coussin carré déhoussable
Quadratisches Kissen (abziehbar)
Cuscino quadrato sfoderabile



693-112

☆ 34 x 34 x 10 cm

♡ 20 x 20 x 8 cm

☾ 26 x 20 x 8 cm

Set 3 decorative cushions
Set 3 cojines infantiles decoración

Set 3 coussins décoratifs
Set 3 Dekokissen
Set 3 cuscini da decorazione



689-902

36 x 43 x 12 cm

Kids cushion · Mountains
Cojín infantil · Montañas

Coussin enfant · Montagnes
Kinder-Kissen · Berge
Cuscino decorativo · Montagna



691-112

32 x 36 x 10 cm

Kids cushion · Teepee tent
Cojín infantil · Tipi

Coussin enfant · Tipi
Kinder-Kissen · Tipi
Cuscino decorativo · Tenda



692E-112

35 x 43 x 11 cm

Kids cushion · Triangle
Cojín infantil · Triángulo

Coussin enfant · Triangle
Kinder-Kissen · Dreieck
Cuscino decorativo · Triangolo



692L-902

35 x 43 x 11 cm

Kids cushion · Triangle
Cojín infantil · Triángulo

Coussin enfant · Triangle
Kinder-Kissen · Dreieck
Cuscino decorativo · Triangolo



INDIANA ROSA 112

COLLECTION

697C-112

15 x 114 x 58 cm

Large pregnancy pillow (cover + pad)
Cojín de maternidad (funda + relleno)
 Coussin de maternité (housse + garnissage)
 Schwangerschaftskissen (Bezug + Füllung)
 Cuscino premaman grande (fodera + imbottitura)



696-112

15 x 55 x 50 cm

Nursing pillow with removable cover (cover + pad)
Cojín de lactancia desenfundable (funda + relleno)
 Coussin d'allaitement déhoussable (housse + garnissage)
 Stillkissen - abziehbar (Bezug + Füllung)
 Cuscino allattamento sfoderabile (fodera + imbottitura)



60x120

612-112

110 x 150 cm

Cot sheets set - 3 pieces (100% Cotton)
Sábanas cuna - 3 piezas (100% Algodón)
 Parure de lit - 3 pièces (100% Coton)
 Bettwäsche - 3 tlg. (100% Baumwolle)
 Lenzuola lettino - 3 pezzi (100% Cotone)

70x140

632-112

135 x 175 cm

616-112

95 x 122 cm

Crib sheets set - 3 pieces (100% Cotton)
Sábanas minicuna - 3 piezas (100% Algodón)
 Parure de berceau - 3 pièces (100% Coton)
 Bettwäsche für Wiege 3-tlg. (100% Baumwolle)
 Lenzuola culla - 3 pezzi (100% Cotone)



698-112

26 x 29 x 18 cm

26 x 42 x 18 cm

Sleep positioner with removable cover
Cojín Antivuelco bebé desenfundable
 Cale-bébé déhoussable
 Seitenschläferkissen (abziehbar)
 Riduttore dormisicuro sfoderabile



60x120

606-112

90 x 123 cm

Duvet cover (with duvet)
Nórdico (con relleno)
 Housse et couette
 Bettbezug (mit Decke)
 Piumino nordico (con imbottitura)

70x140

626-112

105 x 143 cm

60x120

606F-112

90 x 123 cm

Duvet cover (without duvet)
Funda nórdica (sin relleno)
 Housse pour couette
 Bettbezug (ohne Decke)
 Copripiumino nordico (senza imbottitura)

70x140

626F-112

105 x 143 cm



60x120

607-112

180 x 44 cm

Bumper Protector
 Tour de lit
 Nestchen
 Paracolpi

70x140

627-112

210 x 44 cm



60x120

9L2N-112

Bumper + Duvet cover (with duvet) | Protector + Nórdico (con relleno)
 Tour de lit + Housse et couette | Nestchen + Bettbezug (mit Decke)
 Paracolpi + Piumino nordico (con imbottitura)

70x140

9L2NG-112

TEXTILES

631-151

15 x 60 x 90 cm



Top changer for Konver 70x140 and chest
Vestidor para Konver 70x140 y cómoda
 Matelas à langer pour Konver 70x140 et commode
 Wickelaufgabe für Konver 70x140 und Kommode
 Fasciatoio Konver 70x140 e cassetiera



633-151

82 x 10 x 51 cm



Bath changer cover without foam
Funda vestidor sin espuma para bañeras
 Housse supplémentaire sans mousse pour baignoires
 Bezug für Wickelaufgabe ohne Schaumstoff für Waschtisch
 Fodera fasciatoio (senza materassino) per bagnetti



634-151

65 x 8 x 46 cm



Top changer for Konver 60x120 and Twins
Vestidor para Konver 60x120 y Twins
 Matelas à langer pour Konver 60x120 et Twins
 Wickelaufgabe für Konver 60x120 und Twins
 Fasciatoio Konver 60x120 e Twins



* Inside foam ref. R-VE1 not included | Espuma interior Ref. R-VE1, no incluida
 Mousse intérieure Réf. R-VE1 pas incluse | Wickelaufgabe Ref. R-VE1 nicht inklusive
 Materassino Rif. R-VE1, non incluso

Ref. A0631-B

Towelling liner for 631 | Recambio rizo para 631
 Serviette pour réf. 631 | Frotteebezug für 631 | Ricambio fasciatoio Rif. 631

Ref. A0633-B

Towelling liner for 633 | Recambio rizo para 633
 Serviette pour réf. 633 | Frotteebezug für 633 | Ricambio fasciatoio Rif. 633

Ref. A0634-B

Towelling liner for 634 | Recambio rizo para 634
 Serviette pour réf. 634 | Frotteebezug für 634 | Ricambio fasciatoio Rif. 634

670-151

67 x 94 x 65 cm



Crib (colour 23 white gloss)
Minicuna (color 23 blanco brillo)
 Berceau (couleur 23 blanc brillant)
 Wiege (Farbe 23 glänzendes Weiss)
 Culla (colore 23 bianco lucido)

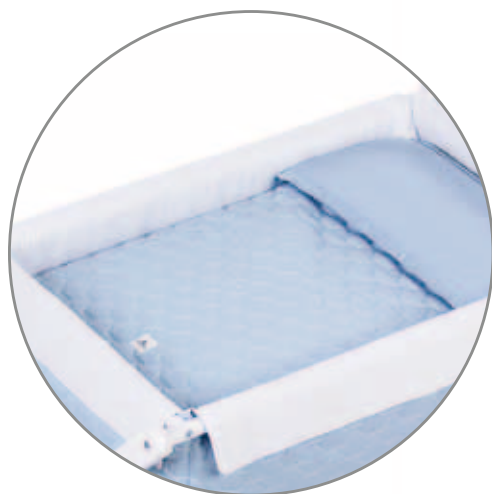

NAVIO 151

COLLECTION

TEXTILES | TEXTILES | LAYETTE | TEXTILIEN | TESSILE



TEXTILES

618-151

21 x 30 x 20 cm

Padded baby toiletries basket

Cesta colonias infantil acolchada

Panier matelassé pour produits de soin

Gefütterter Stoffkorb für Badeartikel

Cestino portasaponi trapuntato



619-151

41 x 34 x 34 cm

Padded fabric storage basket

Saco de juguetes textil acolchado

Panier de rangement matelassé

Gefütterter Korb für Spielwaren

Sacco portagiocchi trapuntato



690A-151

35 x 35 x 15 cm

Square cushion with removable cover

Cojín infantil cuadrado desenfundable

Coussin carré déhoussable

Quadratisches Kissen (abziehbar)

Cuscino quadrato sfoderabile



693-151

☆ 34 x 34 x 10 cm

♡ 20 x 20 x 8 cm

☾ 26 x 20 x 8 cm

Set 3 decorative cushions

Set 3 cojines infantiles decoración

Set 3 coussins décoratifs

Set 3 Dekokissen

Set 3 cuscini da decorazione



694-151

▼ 18 x 12 cm

Garland-pennants (2,50 m long)

Guiraldas-banderines infantiles (2,50 m largo)

Guirlande-banderole (2,50 m longueur)

Stoff-Girlande (2,50 m lang)

Ghirlanda-bandierine (2,50 m. lunghezza)



688L-900

36 x 46 x 11 cm

Kids cushion · Ship

Cojín infantil · Barco

Coussin enfant · Bateau

Kinder-Kissen · Schiff

Cuscino decorativo · Barchetta



688A-151

36 x 46 x 11 cm

Kids cushion · Ship

Cojín infantil · Barco

Coussin enfant · Bateau

Kinder-Kissen · Schiff

Cuscino decorativo · Barchetta



692L-900

35 x 43 x 11 cm

Kids cushion · Triangle

Cojín infantil · Triángulo

Coussin enfant · Triangle

Kinder-Kissen · Dreieck

Cuscino decorativo · Triangolo



692L-901

35 x 43 x 11 cm

Kids cushion · Triangle

Cojín infantil · Triángulo

Coussin enfant · Triangle

Kinder-Kissen · Dreieck

Cuscino decorativo · Triangolo



NAVIO 151

COLLECTION

697C-151

15 x 114 x 58 cm

Large pregnancy pillow (cover + pad)

Cojín de maternidad (funda + relleno)

Coussin de maternité (housse + garnissage)

Schwangerschaftskissen (Bezug + Füllung)

Cuscino premaman grande (fodera + imbottitura)



696-151

15 x 55 x 50 cm

Nursing pillow with removable cover (cover + pad)

Cojín de lactancia desenfundable (funda + relleno)

Coussin d'allaitement déhoussable (housse + garnissage)

Stillkissen · abziehbar (Bezug + Füllung)

Cuscino allattamento sfoderabile (fodera + imbottitura)



60x120

612-151

110 x 150 cm

Cot sheets set - 3 pieces (100% Cotton)

Sábanas cuna - 3 piezas (100% Algodón)

Parure de lit - 3 pièces (100% Coton)

Bettwäsche - 3 tlg. (100% Baumwolle)

Lenzuola lettino - 3 pezzi (100% Cotone)

70x140

632-151

135 x 175 cm

616-151

95 x 122 cm

Crib sheets set - 3 pieces (100% Cotton)

Sábanas minicuna - 3 piezas (100% Algodón)

Parure de berceau - 3 pièces (100% Coton)

Bettwäsche für Wiege 3-tlg. (100% Baumwolle)

Lenzuola culla - 3 pezzi (100% Cotone)



698-151

26 x 29 x 18 cm

26 x 42 x 18 cm

Sleep positioner with removable cover

Cojín Antivuelco bebé desenfundable

Cale-bébé déhoussable

Seitenschläferkissen (abziehbar)

Riduttore dormisicuro sfoderabile



60x120

606-151

90 x 123 cm

Duvet cover (with duvet)

Nórdico (con relleno)

Housse et couette

Bettbezug (mit Decke)

Piumino nordico (con imbottitura)

70x140

626-151

105 x 143 cm

60x120

606F-151

90 x 123 cm

Duvet cover (without duvet)

Funda nórdica (sin relleno)

Housse pour couette

Bettbezug (ohne Decke)

Copripiumino nordico (senza imbottitura)

70x140

626F-151

105 x 143 cm



60x120

607-151

180 x 44 cm

Bumper Protector

Tour de lit

Nestchen

Paracolpi

70x140

627-151

210 x 44 cm



60x120

9L2N-151

Bumper + Duvet cover (with duvet) | Protector + Nórdico (con relleno)

Tour de lit + Housse et couette | *Nestchen + Bettbezug (mit Decke)*

Paracolpi + Piumino nordico (con imbottitura)

70x140

9L2NG-151

TEXTILES

631-111

15 x 60 x 90 cm



Top changer for Konver 70x140 and chest
Vestidor para Konver 70x140 y cómoda
 Matelas à langer pour Konver 70x140 et commode
 Wickelaufgabe für Konver 70x140 und Kommode
 Fasciatoio Konver 70x140 e cassetiera



633-111

82 x 10 x 51 cm



Bath changer cover without foam
Funda vestidor sin espuma para bañeras
 Housse supplémentaire sans mousse pour baignoires
 Bezug für Wickelaufgabe ohne Schaumstoff für Waschtisch
 Fodera fasciatoio (senza materassino) per bagnetti



634-111

65 x 8 x 46 cm



Top changer for Konver 60x120 and Twins
Vestidor para Konver 60x120 y Twins
 Matelas à langer pour Konver 60x120 et Twins
 Wickelaufgabe für Konver 60x120 und Twins
 Fasciatoio Konver 60x120 e Twins



* Inside foam ref. R-VE1 not included | Espuma interior Ref. R-VE1, no incluida
 Mousse intérieure Réf. R-VE1 pas incluse | Wickelaufgabe Ref. R-VE1 nicht inklusive
 Materassino Rif. R-VE1, non incluso

Ref. A0631-B

Towelling liner for 631 | Recambio rizo para 631

Serviette pour réf. 631 | Frotteebezug für 631 | Ricambio fasciatoio Rif. 631

Ref. A0633-B

Towelling liner for 633 | Recambio rizo para 633

Serviette pour réf. 633 | Frotteebezug für 633 | Ricambio fasciatoio Rif. 633

Ref. A0634-B

Towelling liner for 634 | Recambio rizo para 634

Serviette pour réf. 634 | Frotteebezug für 634 | Ricambio fasciatoio Rif. 634

670-111

67 x 94 x 65 cm



Crib (colour 23 white gloss)
Minicuna (color 23 blanco brillo)
 Berceau (couleur 23 blanc brillant)
 Wiege (Farbe 23 glänzendes Weiss)
 Culla (colore 23 bianco lucido)



646-111

115 x 115 x 132 cm

Kids tepee tent
Tipi infantil
 Tipi enfant
 Tipi- Kinderzelt
 Tenda indiana



647-111

115 x 115 cm

Carpet for tepee tent
Alfombra para Tipi infantil
 Tapis pour tipi
 Teppich für Tipi- Kinderzelt
 Tappeto per tenda indiana



INDIANA BLU 111

COLLECTION

TEXTILES | TEXTILES | LAYETTE | TEXTILIEN | TESSILE



TEXTILES

618-111

21 x 30 x 20 cm

Padded baby toiletries basket
Cesta colonias infantil acolchada

Panier matelassé pour produits de soin
Gefütterter Stoffkorb für Badeartikel
Cestino portasaponi trapuntato



619-111

41 x 34 x 34 cm

Padded fabric storage basket
Saco de juguetes textil acolchado

Panier de rangement matelassé
Gefütterter Korb für Spielwaren
Sacco portagiochi trapuntato



694-111

18 x 12 cm

Garland-pennants (2,50 m long)
Guiraldas-banderines infantiles (2,50 m largo)

Guirlande-banderole (2,50 m longueur)
Stoff-Girlande (2,50 m lang)
Ghirlanda-bandierine (2,50 m. lunghezza)

x16



690E-111

35 x 35 x 15 cm

Square cushion with removable cover
Cojín infantil cuadrado desenfundable

Coussin carré déhoussable
Quadratisches Kissen (abziehbar)
Cuscino quadrato sfoderabile



690L-111

35 x 35 x 15 cm

Square cushion with removable cover
Cojín infantil cuadrado desenfundable

Coussin carré déhoussable
Quadratisches Kissen (abziehbar)
Cuscino quadrato sfoderabile



693-111

☆ 34 x 34 x 10 cm

♡ 20 x 20 x 8 cm

☾ 26 x 20 x 8 cm

Set 3 decorative cushions
Set 3 cojines infantiles decoración

Set 3 coussins décoratifs
Set 3 Dekokissen
Set 3 cuscini da decorazione

Set
3
pieces



689-111

36 x 43 x 12 cm

Kids cushion · Mountains
Cojín infantil · Montañas

Coussin enfant · Montagnes
Kinder-Kissen · Berge
Cuscino decorativo · Montagna



691-111

32 x 36 x 10 cm

Kids cushion · Teepee tent
Cojín infantil · Tipi

Coussin enfant · Tipi
Kinder-Kissen · Tipi
Cuscino decorativo · Tenda



692E-111

35 x 43 x 11 cm

Kids cushion · Triangle
Cojín infantil · Triángulo

Coussin enfant · Triangle
Kinder-Kissen · Dreieck
Cuscino decorativo · Triangolo



692L-901

35 x 43 x 11 cm

Kids cushion · Triangle
Cojín infantil · Triángulo

Coussin enfant · Triangle
Kinder-Kissen · Dreieck
Cuscino decorativo · Triangolo



INDIANA BLU 111

COLLECTION

697C-111

15 x 114 x 58 cm

Large pregnancy pillow (cover + pad)

Cojín de maternidad (funda + relleno)

Coussin de maternité (housse + garnissage)

Schwangerschaftskissen (Bezug + Füllung)

Cuscino premaman grande (fodera + imbottitura)



696-111

15 x 55 x 50 cm

Nursing pillow with removable cover (cover + pad)

Cojín de lactancia desenfundable (funda + relleno)

Coussin d'allaitement déhoussable (housse + garnissage)

Stillkissen · abziehbar (Bezug + Füllung)

Cuscino allattamento sfoderabile (fodera + imbottitura)



60x120

612-111

110 x 150 cm

Cot sheets set - 3 pieces (100% Cotton)

Sábanas cuna - 3 piezas (100% Algodón)

Parure de lit - 3 pièces (100% Coton)

Bettwäsche - 3 tlg. (100% Baumwolle)

Lenzuola lettino - 3 pezzi (100% Cotone)

70x140

632-111

135 x 175 cm



616-111

95 x 122 cm

Crib sheets set - 3 pieces (100% Cotton)

Sábanas minicuna - 3 piezas (100% Algodón)

Parure de berceau - 3 pièces (100% Coton)

Bettwäsche für Wiege 3-tlg. (100% Baumwolle)

Lenzuola culla - 3 pezzi (100% Cotone)



698-111

26 x 29 x 18 cm

26 x 42 x 18 cm

Sleep positioner with removable cover

Cojín Antivuelco bebé desenfundable

Cale-bébé déhoussable

Seitenschläferkissen (abziehbar)

Riduttore dormisicuro sfoderabile



60x120

606-111

90 x 123 cm

Duvet cover (with duvet)

Nórdico (con relleno)

Housse et couette

Bettbezug (mit Decke)

Piumino nordico (con imbottitura)

70x140

626-111

105 x 143 cm



60x120

607-111

180 x 44 cm

Bumper Protector

Tour de lit

Nestchen

Paracolpi

70x140

627-111

210 x 44 cm



60x120

606F-111

90 x 123 cm

Duvet cover (without duvet)

Funda nórdica (sin relleno)

Housse pour couette

Bettbezug (ohne Decke)

Copripiumino nordico (senza imbottitura)

70x140

626F-111

105 x 143 cm



60x120

9L2N-111

Bumper + Duvet cover (with duvet) | Protector + Nórdico (con relleno)

Tour de lit + Housse et couette | *Nestchen + Bettbezug (mit Decke)*

Paracolpi + Piumino nordico (con imbottitura)

70x140

9L2NG-111

TEXTILES

631-152

15 x 60 x 90 cm



Top changer for Konver 70x140 and chest
Vestidor para Konver 70x140 y cómoda
 Matelas à langer pour Konver 70x140 et commode
 Wickelaufgabe für Konver 70x140 und Kommode
 Fasciatoio Konver 70x140 e cassetiera



633-152

82 x 10 x 51 cm



Bath changer cover without foam
Funda vestidor sin espuma para bañeras
 Housse supplémentaire sans mousse pour baignoires
 Bezug für Wickelaufgabe ohne Schaumstoff für Waschtisch
 Fodera fasciatoio (senza materassino) per bagnetti



634-152

65 x 8 x 46 cm



Top changer for Konver 60x120 and Twins
Vestidor para Konver 60x120 y Twins
 Matelas à langer pour Konver 60x120 et Twins
 Wickelaufgabe für Konver 60x120 und Twins
 Fasciatoio Konver 60x120 e Twins



* Inside foam ref. R-VE1 not included | Espuma interior Ref. R-VE1, no incluida
 Mousse intérieure Ref. R-VE1 pas incluse | Wickelaufgabe Ref. R-VE1 nicht inklusive
 Materassino Rif. R-VE1, non incluso

Ref. A0631-B

Towelling liner for 631 | Recambio rizo para 631

Serviette pour réf. 631 | Frotteebezug für 631 | Ricambio fasciatoio Rif. 631

Ref. A0633-B

Towelling liner for 633 | Recambio rizo para 633

Serviette pour réf. 633 | Frotteebezug für 633 | Ricambio fasciatoio Rif. 633

Ref. A0634-B

Towelling liner for 634 | Recambio rizo para 634

Serviette pour réf. 634 | Frotteebezug für 634 | Ricambio fasciatoio Rif. 634

670-152

67 x 94 x 65 cm



Crib (colour 23 white gloss)
Minicuna (color 23 blanco brillo)
 Berceau (couleur 23 blanc brillant)
 Wiege (Farbe 23 glänzendes Weiss)
 Culla (colore 23 bianco lucido)



TEXTILES | TEXTILES | LAYETTE | TEXTILIEN | TESSILE

AROSA 152

COLLECTION



TEXTILES

618-152

21 x 30 x 20 cm

Padded baby toiletries basket

Cesta colonias infantil acolchada

Panier matelassé pour produits de soin

Gefütterter Stoffkorb für Badeartikel

Cestino portasaponi trapuntato



619-152

41 x 34 x 34 cm

Padded fabric storage basket

Saco de juguetes textil acolchado

Panier de rangement matelassé

Gefütterter Korb für Spielwaren

Sacco portagiocchi trapuntato



690A-152

35 x 35 x 15 cm

Square cushion with removable cover

Cojín infantil cuadrado desenfundable

Coussin carré déhoussable

Quadratisches Kissen (abziehbar)

Cuscino quadrato sfoderabile



693-152

☆ 34 x 34 x 10 cm

♡ 20 x 20 x 8 cm

☾ 26 x 20 x 8 cm

Set 3 decorative cushions

Set 3 cojines infantiles decoración

Set 3 coussins décoratifs

Set 3 Dekokissen

Set 3 cuscini da decorazione



694-152

▼ 18 x 12 cm

Garland-pennants (2,50 m long)

Guiraldas-banderines infantiles (2,50 m largo)

Guirlande-banderole (2,50 m longueur)

Stoff-Girlande (2,50 m lang)

Ghirlanda-bandierine (2,50 m. lunghezza)



689-902

36 x 43 x 12 cm

Kids cushion · Mountains

Cojín infantil · Montañas

Coussin enfant · Montagnes

Kinder-Kissen · Berge

Cuscino decorativo · Montagna



692L-900

35 x 43 x 11 cm

Kids cushion · Triangle

Cojín infantil · Triángulo

Coussin enfant · Triangle

Kinder-Kissen · Dreieck

Cuscino decorativo · Triangolo



692A-152

35 x 43 x 11 cm

Kids cushion · Triangle

Cojín infantil · Triángulo

Coussin enfant · Triangle

Kinder-Kissen · Dreieck

Cuscino decorativo · Triangolo



692L-902

35 x 43 x 11 cm

Kids cushion · Triangle

Cojín infantil · Triángulo

Coussin enfant · Triangle

Kinder-Kissen · Dreieck

Cuscino decorativo · Triangolo



AROSA 152

COLLECTION

697C-152

15 x 114 x 58 cm

Large pregnancy pillow (cover + pad)
Cojín de maternidad (funda + relleno)
 Coussin de maternité (housse + garnissage)
Schwangerschaftskissen (Bezug + Füllung)
 Cuscino premaman grande (fodera + imbottitura)



696-152

15 x 55 x 50 cm

Nursing pillow with removable cover (cover + pad)
Cojín de lactancia desenfundable (funda + relleno)
 Coussin d'allaitement déhoussable (housse + garnissage)
Stillkissen · abziehbar (Bezug + Füllung)
 Cuscino allattamento sfoderabile (fodera + imbottitura)



60x120

612-152

110 x 150 cm

Cot sheets set - 3 pieces (100% Cotton)
Sábanas cuna - 3 piezas (100% Algodón)
 Parure de lit - 3 pièces (100% Coton)
Bettwäsche - 3 tlg. (100% Baumwolle)
 Lenzuola lettino - 3 pezzi (100% Cotone)

70x140

632-152

135 x 175 cm



616-152

95 x 122 cm

Crib sheets set - 3 pieces (100% Cotton)
Sábanas minicuna - 3 piezas (100% Algodón)
 Parure de berceau - 3 pièces (100% Coton)
Bettwäsche für Wiege 3-tlg. (100% Baumwolle)
 Lenzuola culla - 3 pezzi (100% Cotone)



698-152

26 x 29 x 18 cm

26 x 42 x 18 cm

Sleep positioner with removable cover
Cojín Antivuelco bebé desenfundable
 Cale-bébé déhoussable
Seitenschläferkissen (abziehbar)
 Riduttore dormisicuro sfoderabile



60x120

606-152

90 x 123 cm

Duvet cover (with duvet)
Nórdico (con relleno)
 Housse et couette
Bettbezug (mit Decke)
 Piumino nordico (con imbottitura)

70x140

626-152

105 x 143 cm



60x120

607-152

180 x 44 cm

Bumper Protector
 Tour de lit
Nestchen
 Paracolpi

70x140

627-152

210 x 44 cm



60x120

606F-152

90 x 123 cm

Duvet cover (without duvet)
Funda nórdica (sin relleno)
 Housse pour couette
Bettbezug (ohne Decke)
 Copripiumino nordico (senza imbottitura)

70x140

626F-152

105 x 143 cm



60x120

9L2N-152

Bumper + Duvet cover (with duvet) | Protector + Nórdico (con relleno)
 Tour de lit + Housse et couette | *Nestchen + Bettbezug (mit Decke)*
 Paracolpi + Piumino nordico (con imbottitura)

70x140

9L2NG-152

TEXTILES

631-181

15 x 60 x 90 cm



Top changer for Konver 70x140 and chest Vestidor para Konver 70x140 y cómoda
 Matelas à langer pour Konver 70x140 et commode
 Wickelaufgabe für Konver 70x140 und Kommode
 Fasciatoio Konver 70x140 e cassetiera

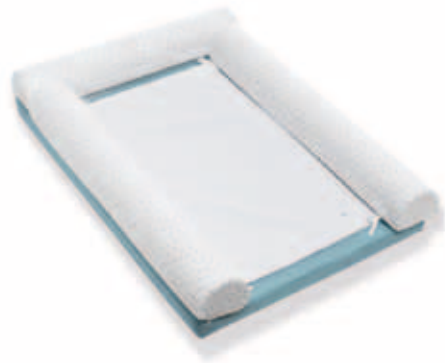

633-181

82 x 10 x 51 cm



Bath changer cover without foam Funda vestidor sin espuma para bañeras
 Housse supplémentaire sans mousse pour baignoires
 Bezug für Wickelaufgabe ohne Schaumstoff für Waschtisch
 Fodera fasciatoio (senza materassino) per bagnetti

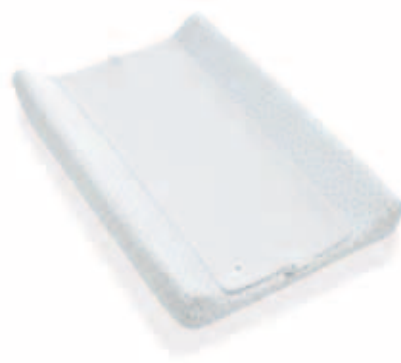

634-181

65 x 8 x 46 cm



Top changer for Konver 60x120 and Twins Vestidor para Konver 60x120 y Twins
 Matelas à langer pour Konver 60x120 et Twins
 Wickelaufgabe für Konver 60x120 und Twins
 Fasciatoio Konver 60x120 e Twins

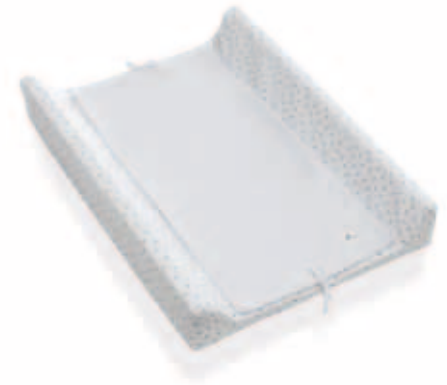

* Inside foam ref. R-VE1 not included | Espuma interior Ref. R-VE1, no incluida
 Mousse intérieure Réf. R-VE1 pas incluse | Wickelaufgabe Ref. R-VE1 nicht inklusive
 Materassino Rif. R-VE1, non incluso

Ref. A0631

Towelling liner for 631 | Recambio rizo para 631
 Serviette pour réf. 631 | Frotteebezug für 631 | Ricambio fasciatoio Rif. 631

Ref. A0633

Towelling liner for 633 | Recambio rizo para 633
 Serviette pour réf. 633 | Frotteebezug für 633 | Ricambio fasciatoio Rif. 633

Ref. A0634

Towelling liner for 634 | Recambio rizo para 634
 Serviette pour réf. 634 | Frotteebezug für 634 | Ricambio fasciatoio Rif. 634

670-18123

67 x 94 x 65 cm



Crib (colour 23 white gloss) Micicuna (color 23 blanco brillo)
 Berceau (couleur 23 blanc brillant)
 Wiege (Farbe 23 glänzendes Weiss)
 Culla (colore 23 bianco lucido)



646-181

115 x 115 x 132 cm

Kids tepee tent Tipi infantil
 Tipi enfant
 Tipi- Kinderzelt
 Tenda indiana



647-181

115 x 115 cm

Carpet for tepee tent Alfombra para Tipi infantil
 Tapis pour tipi
 Teppich für Tipi- Kinderzelt
 Tappeto per tenda indiana

TEXTILES | TEXTILES | LAYETTE | TEXTILIEN | TESSILE

MARE 181

COLLECTION



TEXTILES

693-181

- ☆ 34 x 34 x 10 cm
- ♡ 20 x 20 x 8 cm
- ☾ 26 x 20 x 8 cm

Set 3 decorative cushions
Set 3 cojines infantiles decoración
Set 3 coussins décoratifs
Set 3 Dekokissen
Set 3 cuscini da decorazione

Set
3
pieces



690E-181

35 x 35 x 15 cm



Square cushion with removable cover
Cojín infantil cuadrado desenfundable
Coussin carré déhoussable
Quadratisches Kissen (abziehbar)
Cuscino quadrato sfoderabile



690L-181

35 x 35 x 15 cm



Square cushion with removable cover
Cojín infantil cuadrado desenfundable
Coussin carré déhoussable
Quadratisches Kissen (abziehbar)
Cuscino quadrato sfoderabile



696-181

15 x 55 x 50 cm



Nursing pillow with removable cover (cover + pad)
Cojín de lactancia desenfundable (funda + relleno)
Coussin d'allaitement déhoussable (housse + garnissage)
Stillkissen · abziehbar (Bezug + Füllung)
Cuscino allattamento sfoderabile (fodera + imbottitura)



697C-181

15 x 114 x 58 cm



Large pregnancy pillow (cover + pad)
Cojín de maternidad (funda + relleno)
Coussin de maternité (housse + garnissage)
Schwangerschaftskissen (Bezug + Füllung)
Cuscino premaman grande (fodera + imbottitura)



697H-181

19 x 48 x 59 cm



2-in-1 pregnancy pillow and infant seat
Cojín de maternidad y hamaquita 2 en 1
Coussin de maternité et transat 2 en 1
2 in 1 Schwangerschaftskissen und Babysitz
2 in 1 cuscino premaman con fodera amaca



Ref. 696F

Fabric cover for nursing pillow 696 | Funda tela cojín de lactancia 696
Housse pour coussin d'allaitement 696 | Bezug für Stillkissen (Ref. 696)
Fodera in tessuto per cuscino allattamento 696

698-181

- ☐ 26 x 29 x 18 cm
- ☐ 26 x 42 x 18 cm

Sleep positioner with removable cover
Cojín Antivuelco bebé desenfundable
Cale-bébé déhoussable
Seitenschlãferkissen (abziehbar)
Riduttore dormisicuro sfoderabile



619-181

41 x 34 x 34 cm

Padded fabric storage basket
Saco de juguetes textil acolchado
Panier de rangement matelassé
Gefütterter Korb für Spielwaren
Sacco portagiochi trapuntato



618-181

21 x 30 x 20 cm

Padded baby toiletries basket
Cesta colonias infantil acolchada
Panier matelassé pour produits de soin
Gefütterter Stoffkorb für Badeartikel
Cestino portasaponi trapuntato



694-181

▼ 18 x 12 cm

Garland-pennants (2,50 m long)
Guiraldas-banderines infantiles (2,50 m largo)
Guirlande-banderole (2,50 m longueur)
Stoff-Girlande (2,50 m lang)
Ghirlanda-bandierine (2,50 m. lunghezza)



x16



MARE 181

COLLECTION

60x120

607-181

180 x 44 cm

Bumper Protector
Tour de lit
Nestchen
Paracolpi

70x140

627-181

210 x 44 cm



60x120

606-181

90 x 123 cm

Duvet cover (with duvet)
Nórdico (con relleno)

Housse et couette
Bettbezug (mit Decke)
Piumino nordico (con imbottitura)

70x140

626-181

105 x 143 cm



60x120

606F-181

90 x 123 cm

Duvet cover (without duvet)
Funda nórdica (sin relleno)

Housse pour couette
Bettbezug (ohne Decke)
Copripiumino nordico (senza imbottitura)

70x140

626F-181

105 x 143 cm



60x120

612-181

110 x 150 cm

Cot sheets set - 3 pieces (100% Cotton)
Sábanas cuna - 3 piezas (100% Algodón)
Parure de lit - 3 pièces (100% Coton)
Bettwäsche - 3 tlg. (100% Baumwolle)
Lenzuola lettino - 3 pezzi (100% Cotone)

70x140

632-181

135 x 175 cm

616-181

95 x 122 cm

Crib sheets set - 3 pieces (100% Cotton)
Sábanas minicuna - 3 piezas (100% Algodón)
Parure de berceau - 3 pièces (100% Coton)
Bettwäsche für Wiege 3-tlg. (100% Baumwolle)
Lenzuola culla - 3 pezzi (100% Cotone)

Set
3
pieces



60x120

9L2N-181

Bumper + Duvet cover (with duvet) | Protector + Nórdico (con relleno)
Tour de lit + Housse et couette | *Nestchen + Bettbezug (mit Decke)*
Paracolpi + Piumino nordico (con imbottitura)

70x140

9L2NG-181

TEXTILES

631-182

15 x 60 x 90 cm



Top changer for Konver 70x140 and chest
Vestidor para Konver 70x140 y cómoda
 Matelas à langer pour Konver 70x140 et commode
 Wickelaufgabe für Konver 70x140 und Kommode
 Fasciatoio Konver 70x140 e cassettiera



633-182

82 x 10 x 51 cm



Bath changer cover without foam
Funda vestidor sin espuma para bañeras
 Housse supplémentaire sans mousse pour baignoires
 Bezug für Wickelaufgabe ohne Schaumstoff für Waschtisch
 Fodera fasciatoio (senza materassino) per bagnetti



634-182

65 x 8 x 46 cm



Top changer for Konver 60x120 and Twins
Vestidor para Konver 60x120 y Twins
 Matelas à langer pour Konver 60x120 et Twins
 Wickelaufgabe für Konver 60x120 und Twins
 Fasciatoio Konver 60x120 e Twins

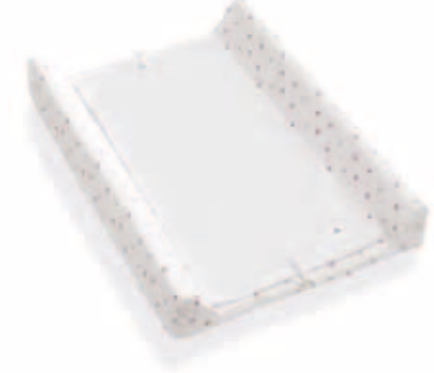

* Inside foam ref. R-VE1 not included | Espuma interior Ref. R-VE1, no incluida
 Mousse intérieure Réf. R-VE1 pas incluse | Wickelaufgabe Ref. R-VE1 nicht inklusive
 Materassino Rif. R-VE1, non incluso

Ref. A0631

Towelling liner for 631 | Recambio rizo para 631
 Serviette pour réf. 631 | Frotteebezug für 631 | Ricambio fasciatoio Rif. 631

Ref. A0633

Towelling liner for 633 | Recambio rizo para 633
 Serviette pour réf. 633 | Frotteebezug für 633 | Ricambio fasciatoio Rif. 633

Ref. A0634

Towelling liner for 634 | Recambio rizo para 634
 Serviette pour réf. 634 | Frotteebezug für 634 | Ricambio fasciatoio Rif. 634

670-18223

67 x 94 x 65 cm



Crib (colour 23 white gloss)
Minicuna (color 23 blanco brillo)
 Berceau (couleur 23 blanc brillant)
 Wiege (Farbe 23 glänzendes Weiss)
 Culla (colore 23 bianco lucido)



646-182

115 x 115 x 132 cm

Kids teepee tent
Tipi infantil
 Tipi enfant
 Tipi- Kinderzelt
 Tenda indiana



647-182

115 x 115 cm

Carpet for teepee tent
Alfombra para Tipi infantil
 Tapis pour tipi
 Teppich für Tipi- Kinderzelt
 Tappeto per tenda indiana

TEXTILES | TEXTILES | LAYETTE | TEXTILIEN | TESSILE

ROSE 182

COLLECTION



TEXTILES

693-182

- ☆ 34 x 34 x 10 cm
- ♡ 20 x 20 x 8 cm
- ☾ 26 x 20 x 8 cm

Set 3 decorative cushions
Set 3 cojines infantiles decoración
Set 3 coussins décoratifs
Set 3 Dekokissen
Set 3 cuscini da decorazione

Set
3
pieces



690E-182

35 x 35 x 15 cm



Square cushion with removable cover
Cojín infantil cuadrado desenfundable
Coussin carré déhoussable
Quadratisches Kissen (abziehbar)
Cuscino quadrato sfoderabile



690L-182

35 x 35 x 15 cm



Square cushion with removable cover
Cojín infantil cuadrado desenfundable
Coussin carré déhoussable
Quadratisches Kissen (abziehbar)
Cuscino quadrato sfoderabile



696-182

15 x 55 x 50 cm



Nursing pillow with removable cover (cover + pad)
Cojín de lactancia desenfundable (funda + relleno)
Coussin d'allaitement déhoussable (housse + garnissage)
Stillkissen · abziehbar (Bezug + Füllung)
Cuscino allattamento sfoderabile (fodera + imbottitura)



697C-182

15 x 114 x 58 cm



Large pregnancy pillow (cover + pad)
Cojín de maternidad (funda + relleno)
Coussin de maternité (housse + garnissage)
Schwangerschaftskissen (Bezug + Füllung)
Cuscino premaman grande (fodera + imbottitura)



697H-182

19 x 48 x 59 cm



2-in-1 pregnancy pillow and infant seat
Cojín de maternidad y hamaquita 2 en 1
Coussin de maternité et transat 2 en 1
2 in 1 Schwangerschaftskissen und Babysitz
2 in 1 cuscino premaman con fodera amaca



Ref. 696F

Fabric cover for nursing pillow 696 | Funda tela cojín de lactancia 696
Housse pour coussin d'allaitement 696 | Bezug für Stillkissen (Ref. 696)
Fodera in tessuto per cuscino allattamento 696

698-182

- ┌ 26 x 29 x 18 cm
- └ 26 x 42 x 18 cm

Sleep positioner with removable cover
Cojín Antivuelco bebé desenfundable
Cale-bébé déhoussable
Seitenschlãferkissen (abziehbar)
Riduttore dormisicuro sfoderabile



619-182

41 x 34 x 34 cm

Padded fabric storage basket
Saco de juguetes textil acolchado
Panier de rangement matelassé
Gefütterter Korb für Spielwaren
Sacco portagiocchi trapuntato



618-182

21 x 30 x 20 cm

Padded baby toiletries basket
Cesta colonias infantil acolchada
Panier matelassé pour produits de soin
Gefütterter Stoffkorb für Badeartikel
Cestino portasaponi trapuntato



694-182

▼ 18 x 12 cm

Garland-pennants (2,50 m long)
Guiraldas-banderines infantiles (2,50 m largo)
Guirlande-banderole (2,50 m longueur)
Stoff-Girlande (2,50 m lang)
Ghirlanda-bandierine (2,50 m. lunghezza)



ROSE 182

COLLECTION

60x120

607-182

180 x 44 cm

Bumper Protector
Tour de lit
Nestchen
Paracolpi

70x140

627-182

210 x 44 cm



60x120

606-182

90 x 123 cm

Duvet cover (with duvet)

Nórdico (con relleno)

Housse et couette

Bettbezug (mit Decke)

Plumino nordico (con imbottitura)

70x140

626-182

105 x 143 cm



60x120

606F-182

90 x 123 cm

Duvet cover (without duvet)

Funda nórdica (sin relleno)

Housse pour couette

Bettbezug (ohne Decke)

Plumino nordico (senza imbottitura)

70x140

626F-182

105 x 143 cm



60x120

612-182

110 x 150 cm

Cot sheets set - 3 pieces (100% Cotton)

Sábanas cuna - 3 piezas (100% Algodón)

Parure de lit - 3 pièces (100% Coton)

Bettwäsche - 3 tlg. (100% Baumwolle)

Lenzuola lettino - 3 pezzi (100% Cotone)

70x140

632-182

135 x 175 cm

616-182

95 x 122 cm

Crib sheets set - 3 pieces (100% Cotton)

Sábanas minicuna - 3 piezas (100% Algodón)

Parure de berceau - 3 pièces (100% Coton)

Bettwäsche für Wiege 3-tlg. (100% Baumwolle)

Lenzuola culla - 3 pezzi (100% Cotone)

Set
3
pieces



60x120

9L2N-182

Bumper + Duvet cover (with duvet) | Protector + Nórdico (con relleno)

Tour de lit + Housse et couette | *Nestchen + Bettbezug (mit Decke)*

Paracolpi + Plumino nordico (con imbottitura)

70x140

9L2NG-182

TEXTILES

631-179

15 x 60 x 90 cm

Top changer for Konver 70x140 and chest
Vestidor para Konver 70x140 y cómoda
 Matelas à langer pour Konver 70x140 et commode
 Wickelaufgabe für Konver 70x140 und Kommode
 Fasciatoio Konver 70x140 e cassettiera

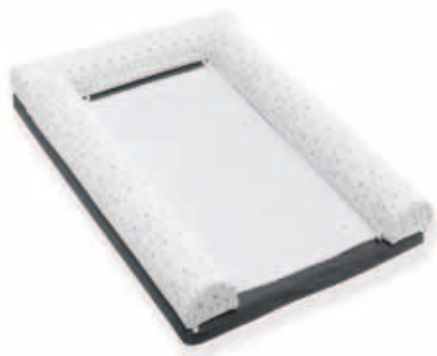

633-179

82 x 10 x 51 cm

Bath changer cover without foam
Funda vestidor sin espuma para bañeras
 Housse supplémentaire sans mousse pour baignoires
 Bezug für Wickelaufgabe ohne Schaumstoff für Waschtisch
 Fodera fasciatoio (senza materassino) per bagnetti



634-179

65 x 8 x 46 cm

Top changer for Konver 60x120 and Twins
Vestidor para Konver 60x120 y Twins
 Matelas à langer pour Konver 60x120 et Twins
 Wickelaufgabe für Konver 60x120 und Twins
 Fasciatoio Konver 60x120 e Twins



* Inside foam ref. R-VE1 not included | Espuma interior Ref. R-VE1, no incluida
 Mousse intérieure Ref. R-VE1 pas incluse | Wickelaufgabe Ref. R-VE1 nicht inklusive
 Materassino Rif. R-VE1, non incluso

Ref. A0631

Towelling liner for 631 | Recambio rizo para 631
 Serviette pour réf. 631 | Frotteebezug für 631 | Ricambio fasciatoio Rif. 631

Ref. A0633

Towelling liner for 633 | Recambio rizo para 633
 Serviette pour réf. 633 | Frotteebezug für 633 | Ricambio fasciatoio Rif. 633

Ref. A0634

Towelling liner for 634 | Recambio rizo para 634
 Serviette pour réf. 634 | Frotteebezug für 634 | Ricambio fasciatoio Rif. 634

670-17923

67 x 94 x 65 cm

Crib (colour 23 white gloss)
Minicuna (color 23 blanco brillo)
 Berceau (couleur 23 blanc brillant)
 Wiege (Farbe 23 glänzendes Weiss)
 Culla (colore 23 bianco lucido)



646-179

115 x 115 x 132 cm

Kids tepee tent
Tipi infantil
 Tipi enfant
 Tipi- Kinderzelt
 Tenda indiana



647-179

115 x 115 cm

Carpet for tepee tent
Alfombra para Tipi infantil
 Tapis pour tipi
 Teppich für Tipi- Kinderzelt
 Tappeto per tenda indiana



693-179

- ☆ 34 x 34 x 10 cm
- ♥ 20 x 20 x 8 cm
- ☾ 26 x 20 x 8 cm

Set 3 decorative cushions
Set 3 cojines infantiles decoración
 Set 3 coussins décoratifs
 Set 3 Dekokissen
 Set 3 cuscini da decorazione

Set
3
pieces



690E-179

35 x 35 x 15 cm



Square cushion with removable cover
Cojín infantil cuadrado desenfundable
 Coussin carré déhoussable
 Quadratisches Kissen (abziehbar)
 Cuscino quadrato sfoderabile



690L-179

35 x 35 x 15 cm



Square cushion with removable cover
Cojín infantil cuadrado desenfundable
 Coussin carré déhoussable
 Quadratisches Kissen (abziehbar)
 Cuscino quadrato sfoderabile



696-179

15 x 55 x 50 cm



Nursing pillow with removable cover (cover + pad)
Cojín de lactancia desenfundable (funda + relleno)
 Coussin d'allaitement déhoussable (housse + garnissage)
 Stillkissen · abziehbar (Bezug + Füllung)
 Cuscino allattamento sfoderabile (fodera + imbottitura)



697C-179

15 x 114 x 58 cm



Large pregnancy pillow (cover + pad)
Cojín de maternidad (funda + relleno)
 Coussin de maternité (housse + garnissage)
 Schwangerschaftskissen (Bezug + Füllung)
 Cuscino premaman grande (fodera + imbottitura)



697H-179

19 x 48 x 59 cm



2-in-1 pregnancy pillow and infant seat
Cojín de maternidad y hamaquita 2 en 1
 Coussin de maternité et transat 2 en 1
 2 in 1 Schwangerschaftskissen und Babysitz
 2 in 1 cuscino premaman con fodera amaca



Ref. 696F

Fabric cover for nursing pillow 696 | Funda tela cojín de lactancia 696
 Housse pour coussin d'allaitement 696 | Bezug für Stillkissen (Ref. 696)
 Fodera in tessuto per cuscino allattamento 696

698-179

- ┌ 26 x 29 x 18 cm
- └ 26 x 42 x 18 cm

Sleep positioner with removable cover
Cojín Antivuelco bebé desenfundable
 Cale-bébé déhoussable
 Seitenschläferkissen (abziehbar)
 Riduttore dormisicuro sfoderabile



619-179

41 x 34 x 34 cm

Padded fabric storage basket
Saco de juguetes textil acolchado
 Panier de rangement matelassé
 Gefütterter Korb für Spielwaren
 Sacco portagiochi trapuntato



618-179

21 x 30 x 20 cm

Padded baby toiletries basket
Cesta colonias infantil acolchada
 Panier matelassé pour produits de soin
 Gefütterter Stoffkorb für Badeartikel
 Cestino portasaponi trapuntato



694-179

▼ 18 x 12 cm

Garland-pennants (2,50 m long)
Guiraldas-banderines infantiles (2,50 m largo)
 Guirlande-banderole (2,50 m longueur)
 Stoff-Girlande (2,50 m lang)
 Ghirlanda-bandierine (2,50 m. lunghezza)



x16



ETNIK 179

COLLECTION

60x120

607-179

180 x 44 cm

Bumper Protector
Tour de lit
Nestchen
Paracolpi

70x140

627-179

210 x 44 cm



60x120

606-179

90 x 123 cm

Duvet cover (with duvet)
Nórdico (con relleno)

Housse et couette
Bettbezug (mit Decke)
Piumino nordico (con imbottitura)

70x140

626-179

105 x 143 cm



60x120

606F-179

90 x 123 cm

Duvet cover (without duvet)
Funda nórdica (sin relleno)

Housse pour couette
Bettbezug (ohne Decke)
Piumino nordico (senza imbottitura)

70x140

626F-179

105 x 143 cm



60x120

612-179

110 x 150 cm

Cot sheets set - 3 pieces (100% Cotton)
Sábanas cuna - 3 piezas (100% Algodón)
Parure de lit - 3 pièces (100% Coton)
Bettwäsche - 3 tlg. (100% Baumwolle)
Lenzuola lettino - 3 pezzi (100% Cotone)

70x140

632-179

135 x 175 cm

616-179

95 x 122 cm

Crib sheets set - 3 pieces (100% Cotton)
Sábanas minicuna - 3 piezas (100% Algodón)
Parure de berceau - 3 pièces (100% Coton)
Bettwäsche für Wiege 3-tlg. (100% Baumwolle)
Lenzuola culla - 3 pezzi (100% Cotone)

Set
3
pieces



60x120

9L2N-179

Bumper + Duvet cover (with duvet) | Protector + Nórdico (con relleno)
Tour de lit + Housse et couette | *Nestchen + Bettbezug (mit Decke)*
Paracolpi + Piumino nordico (con imbottitura)

70x140

9L2NG-179

TEXTILES

MUSLIN SWADDLES | MUSELINAS
LANGES MOUSSELINE | MUSSELIN MULLTÜCHER | MUSSOLE

Printed muslin swaddle blanket
Muselina infantil estampada
Lange en mousseline de coton imprimé
Mulltuch aus bedrucktem Musselin
Mussola neonato stampata

100%
COTTON

120x120
cm



801-181G



801-181P



801-182G



801-182P

DOLCEZZA

MUSLIN

100%
COTTON



TEXTILES

TOYS | JUGUETES | JOUETS | SPIELZEUGE | GIOCATTOLI

TOYS

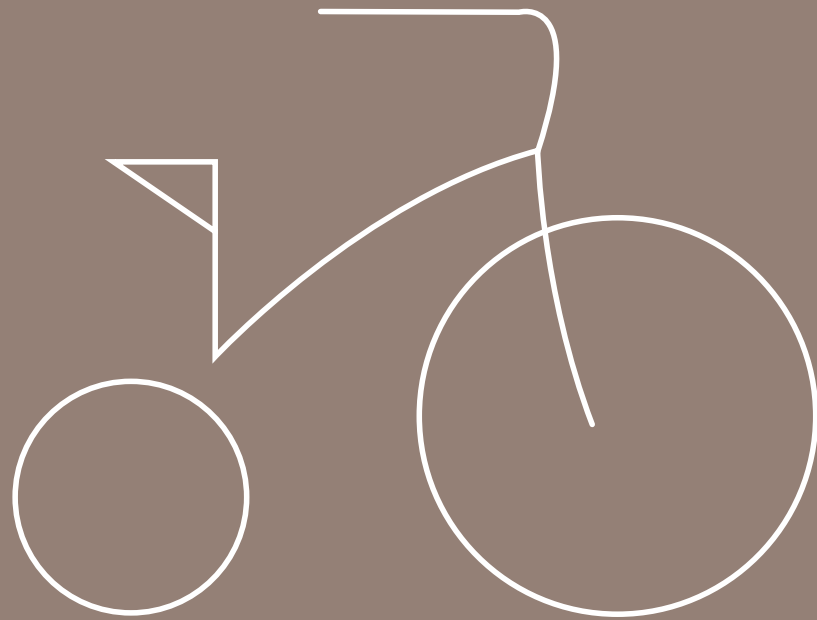

TOYS | JUGUETES | JOUETS | SPIELZEUGE | GIOCATTOLI

WOODEN HORSES WITH WHEELS | CABALLITOS DE MADERA CON RUEDAS
CHEVAUX DE BOIS À ROULETTES | HOLZPFERDE AUF ROLLEN
CAVALLI DI LEGNO CON RUOTE

U31CBR-7700



U31CBR-7751



U31CBR-7752



U31CBR-7753



U31CBR-7778



MEASURES | MEDIDAS | MESURES | MAßE | MISURE



74 cm

29 cm



26,5 cm

48 cm

RIDER

WOODEN HORSES WITH WHEELS



ROCKING HORSES | CABALLITOS BALANCÍN
CHEVAUX À BASCULE | SCHAUKELPFERDE | CAVALLI A DONDOLO

U32CBB-7700



U32CBB-7751



U32CBB-7752



U32CBB-7753



U32CBB-7778



MEASURES | MEDIDAS | MESURES | MAßE | MISURE



ROCKY

ROCKING HORSES



DESK & CHAIR | ESCRITORIO Y SILLA
BUREAU ET CHAISE | *SCHREIBTISCH UND STUHL* | CASETTA/SCRIVANIA E SGABELLO

U33MES-7700



U33MES-7751



U33MES-7752



U33MES-7753



U33MES-7778



MEASURES | MEDIDAS | MESURES | MAßE | MISURE

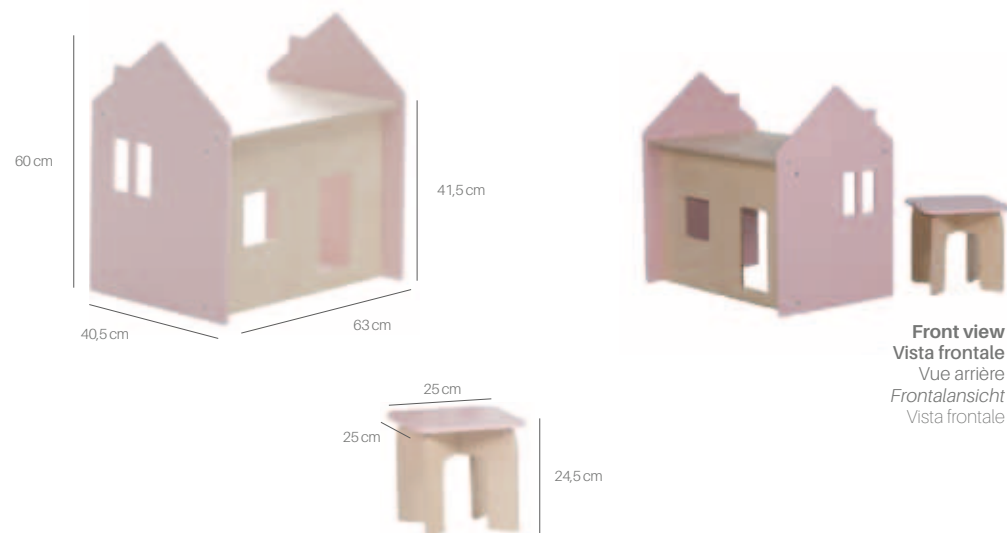

Front view
Vista frontale
Vue arrière
Frontalansicht
Vista frontale

CASA

DESK & CHAIR



TOYS

WOODEN PLANES | AVIONES DE MADERA
AVIONS EN BOIS | HOLZFLUGZEUGE | AEREI DI LEGNO

U34AVI-7700



U34AVI-7751



U34AVI-7753



U34AVI-7778



DETAILS | DETALLES | DÉTAILS | DETAILS | DETTAGLI



Close-up of propeller
Detalle de la hélice
Vue rapprochée de l'hélice
Detailansicht der Luftschaube
Dettaglio elica



Close-up of wheels
Detalle de las ruedas
Vue rapprochée des roues
Detailansicht der Räder
Dettaglio ruote

MEASURES | MEDIDAS | MESURES | MABE | MISURE

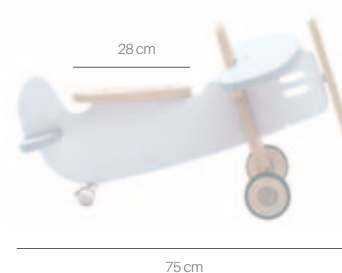

WIND

WOODEN PLANES



DOLL'S PRAM | CARRITO BEBÉ
POUSSETTE POUR POUPEE | *PUPPENWAGEN* | Riduttori DORMISICURO

U36CRT-7700



WOODEN MOTORBIKE | MOTO DE MADERA INFANTIL
MOTO EN BOIS | *HOLZMOTORRAD* | Riduttori DORMISICURO

U35MOT-7700



U36CRT-7752



MEASURES | MEDIDAS | MESURES | MAßE | MISURE

Doll's pram | Carrito de bebé | Poussette pour poupée
Puppenwagen | Passeggino per bambole

Motorbike | Moto | Moto en bois
Holzmotorrad | Moto giocattolo di legno



62 cm

48 cm



84 cm

34 cm



34 cm

48 cm



40 cm

50 cm

PRIX

WOODEN MOTORBIKE

WOODEN MOTORBIKE | MOTO DE MADERA INFANTIL
MOTO EN BOIS | HOLZMOTORRAD | MOTO GIOCATTOLO DI LEGNO



PRINCESS

DOLL'S PRAM

DOLL'S PRAM | CARRITO BEBÉ
POUSSETTE POUR POUPEE | PUPPENWAGEN | PASSEGGINO PER BAMBOLE





Hidden zipper pocket for cell phone
Bolsillo con cremallera para el móvil
Poche zipée pour téléphone portable
Äusseres Reissverschlussfach für Handy
Tasca con cerniera zip per il telefonino



Fastening system for stroller
Sistema de sujeción al carro de paseo
Système d'accroche poussette
Kinderwagenbefestigung
Sistema di aggancio al passeggino



Zipper closure
Cierre con cremallera
Fermeture éclair
Reissverschluss
Chiusura con cerniera zip

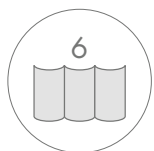

Number of compartments
Número de compartimentos
Nombre de compartiments
Anzahl der inneren Staufächer
Numero di scompartimenti interni

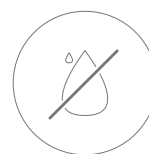

Waterproof lining
Forro interior impermeable
Doublure intérieure imperméable
Inneres Futter wasserdicht
Fodera interna impermeabile



Leatherette
Polipiel
Simili-cuir
Kunstleder
Ecopelle



Velcro closure
Cierre con velcro
Fermeture en scratch
Klettverschluss
Chiusura velcro

URBAN BAGS



BAGS | **BOLSOS** | **SACS** | *TASCHEN* | BORSE

1100-751

33 x 41 x 13 cm

Tote diaper bag
Bolso panera
 Sac à langer
Wickeltasche Tote-Bag
 Borsa passeggio



1400-751

9 x 9 x 9 cm

Pacifier holder
Portachupete
 Porte sucette
Schnullertasche
 Portaciuccio



1702-751

21 x 24 x 3 cm (closed)
 58 x 44 x 3 cm (open)

Changing mat
Cambiador Bebé
 Matelas à langer
Reise-Wickelunterlage
 Fasciatoio da viaggio



1202-751

32 x 42 x 12 cm

Carry all diaper bag
Bolso maternidad
 Sac à langer en bandoulière
Wickeltasche Schultertasche
 Borsa mamma



1500-751

22 x 9 x 9 cm

Bottle holder
Portabiberón
 Porte biberon
Fläschchentasche
 Portabiberon



1900-751

19 x 30 x 8 cm

Toiletry bag
Necesar
 Trousse de toilette
Kulturbeutel
 Trousse toilette



1300-751

35 x 31 x 14 cm

Backpack diaper bag
Mochila maternal
 Sac à dos à langer
Wickeltasche Rucksack
 Zainetto mamma



1601-751

26 x 18 x 2 cm (closed)
 26 x 36 x 2 cm (open)

Document holder
Portadocumentos
 Porte-documents
Dokumententasche
 Portadocumenti



Waterproof lining | Forro interior impermeable
 Doublure intérieure imperméable | Inneres Futter wasserdicht
 Fodera interna impermeabile



Leatherette | Polipiel
 Simili-cuir | Kunstleder
 Ecopelle



UP & DOWN BLU

COLLECTION



URBAN BAGS

1100-777

33 x 41 x 13 cm

Tote diaper bag
Bolso panera
 Sac à langer
Wickeltasche Tote-Bag
 Borsa passeggio



1400-777

9 x 9 x 9 cm

Pacifier holder
Portachupete
 Porte sucette
Schnullertasche
 Portaciuccio



1702-777

21 x 24 x 3 cm (closed)
 58 x 44 x 3 cm (open)

Changing mat
Cambiador Bebé
 Matelas à langer
Reise-Wickelunterlage
 Fasciatoio da viaggio



1202-777

32 x 42 x 12 cm

Carry all diaper bag
Bolso maternidad
 Sac à langer en bandoulière
Wickeltasche Schultertasche
 Borsa mamma



1500-777

22 x 9 x 9 cm

Bottle holder
Portabiberón
 Porte biberon
Fläschchentasche
 Portabiberon



1900-777

19 x 30 x 8 cm

Toiletry bag
Necesar
 Trousse de toilette
Kulturbeutel
 Trousse toilette



1300-777

35 x 31 x 14 cm

Backpack diaper bag
Mochila maternal
 Sac à dos à langer
Wickeltasche Rucksack
 Zainetto mamma

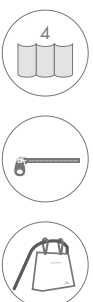

1601-777

26 x 18 x 2 cm (closed)
 26 x 36 x 2 cm (open)

Document holder
Portadocumentos
 Porte-documents
Dokumententasche
 Portadocumenti



Waterproof lining | Forro interior impermeable
 Doublure intérieure imperméable | Inneres Futter wasserdicht
 Fodera interna impermeabile



Leatherette | Polipiel
 Simili-cuir | Kunstleder
 Ecopelle



ONDA WHITE

COLLECTION



URBAN BAGS

1100-752

33 x 41 x 13 cm

Tote diaper bag
Bolso panera
 Sac à langer
 Wickeltasche Tote-Bag
 Borsa passeggio



1400-752

9 x 9 x 9 cm

Pacifier holder
Portachupete
 Porte sucette
 Schnullertasche
 Portaciuccio



1702-752

21 x 24 x 3 cm (closed)
 58 x 44 x 3 cm (open)

Changing mat
Cambiador Bebé
 Matelas à langer
 Reise-Wickelunterlage
 Fasciatoio da viaggio



1202-752

32 x 42 x 12 cm

Carry all diaper bag
Bolso maternidad
 Sac à langer en bandoulière
 Wickeltasche Schultertasche
 Borsa mamma



1500-752

22 x 9 x 9 cm

Bottle holder
Portabiberón
 Porte biberon
 Fläschchentasche
 Portabiberon



1900-752

19 x 30 x 8 cm

Toiletry bag
Necesar
 Trousse de toilette
 Kulturbeutel
 Trousse toilette



1300-752

35 x 31 x 14 cm

Backpack diaper bag
Mochila maternal
 Sac à dos à langer
 Wickeltasche Rucksack
 Zainetto mamma



1601-752

26 x 18 x 2 cm (closed)
 26 x 36 x 2 cm (open)

Document holder
Portadocumentos
 Porte-documents
 Dokumententasche
 Portadocumenti



Waterproof lining | Forro interior impermeable
 Doublure intérieure imperméable | Inneres Futter wasserdicht
 Fodera interna impermeabile



Leatherette | Polipiel
 Simili-cuir | Kunstleder
 Ecopelle



UP & DOWN ROSA

COLLECTION



URBAN BAGS

1100-714

33 x 41 x 13 cm

Tote diaper bag
Bolso panera
 Sac à langer
Wickeltasche Tote-Bag
 Borsa passeggio



1400-714

9 x 9 x 9 cm

Pacifier holder
Portachupete
 Porte sucette
Schnullertasche
 Portaciuccio



1702-714

21 x 24 x 3 cm (closed)
 58 x 44 x 3 cm (open)

Changing mat
Cambiador Bebé
 Matelas à langer
Reise-Wickelunterlage
 Fasciatoio da viaggio



1202-714

32 x 42 x 12 cm

Carry all diaper bag
Bolso maternidad
 Sac à langer en bandoulière
Wickeltasche Schultertasche
 Borsa mamma



1500-714

22 x 9 x 9 cm

Bottle holder
Portabiberón
 Porte biberon
Fläschchentasche
 Portabiberon



1900-714

19 x 30 x 8 cm

Toiletry bag
Necesar
 Trousse de toilette
Kulturbeutel
 Trousse toilette



1300-714

35 x 31 x 14 cm

Backpack diaper bag
Mochila maternal
 Sac à dos à langer
Wickeltasche Rucksack
 Zainetto mamma



1601-714

26 x 18 x 2 cm (closed)
 26 x 36 x 2 cm (open)

Document holder
Portadocumentos
 Porte-documents
Dokumententasche
 Portadocumenti



Waterproof lining | Forro interior impermeable
 Doublure intérieure imperméable | Inneres Futter wasserdicht
 Fodera interna impermeabile



Leatherette | Polipiel
 Simili-cuir | Kunstleder
 Ecopelle



FIORE GREY

COLLECTION



URBAN BAGS

1100-790

33 x 41 x 13 cm

Tote diaper bag
Bolso panera
 Sac à langer
Wickeltasche Tote-Bag
 Borsa passeggio



1400-790

9 x 9 x 9 cm

Pacifier holder
Portachupete
 Porte sucette
Schnullertasche
 Portaciuccio



1702-790

21 x 24 x 3 cm (closed)
 58 x 44 x 3 cm (open)

Changing mat
Cambiador Bebé
 Matelas à langer
Reise-Wickelunterlage
 Fasciatoio da viaggio



1202-790

32 x 42 x 12 cm

Carry all diaper bag
Bolso maternidad
 Sac à langer en bandoulière
Wickeltasche Schultertasche
 Borsa mamma



1500-790

22 x 9 x 9 cm

Bottle holder
Portabiberón
 Porte biberon
Fläschchentasche
 Portabiberon



1900-790

19 x 30 x 8 cm

Toiletry bag
Necesar
 Trousse de toilette
Kulturbeutel
 Trousse toilette



1300-790

35 x 31 x 14 cm

Backpack diaper bag
Mochila maternal
 Sac à dos à langer
Wickeltasche Rucksack
 Zainetto mamma



1601-790

26 x 18 x 2 cm (closed)
 26 x 36 x 2 cm (open)

Document holder
Portadocumentos
 Porte-documents
Dokumententasche
 Portadocumenti



Waterproof lining | Forro interior impermeable
 Doublure intérieure imperméable | Inneres Futter wasserdicht
 Fodera interna impermeabile



Leatherette | Polipiel
 Simili-cuir | Kunstleder
 Ecopelle



FIORE WHITE

COLLECTION



URBAN BAGS

1100-778

33 x 41 x 13 cm

Tote diaper bag
Bolso panera
 Sac à langer
Wickeltasche Tote-Bag
 Borsa passeggio



1400-778

9 x 9 x 9 cm

Pacifier holder
Portachupete
 Porte sucette
Schnullertasche
 Portaciuccio



1702-778

21 x 24 x 3 cm (closed)
 58 x 44 x 3 cm (open)

Changing mat
Cambiador Bebé
 Matelas à langer
Reise-Wickelunterlage
 Fasciatoio da viaggio



1202-778

32 x 42 x 12 cm

Carry all diaper bag
Bolso maternidad
 Sac à langer en bandoulière
Wickeltasche Schultertasche
 Borsa mamma



1500-778

22 x 9 x 9 cm

Bottle holder
Portabiberón
 Porte biberon
Fläschchentasche
 Portabiberon



1900-778

19 x 30 x 8 cm

Toiletry bag
Necesar
 Trousse de toilette
Kulturbeutel
 Trousse toilette



1300-778

35 x 31 x 14 cm

Backpack diaper bag
Mochila maternal
 Sac à dos à langer
Wickeltasche Rucksack
 Zainetto mamma



1601-778

26 x 18 x 2 cm (closed)
 26 x 36 x 2 cm (open)

Document holder
Portadocumentos
 Porte-documents
Dokumententasche
 Portadocumenti



Waterproof lining | Forro interior impermeable
 Doublure intérieure imperméable | Inneres Futter wasserdicht
 Fodera interna impermeabile



Leatherette | Polipiel
 Simili-cuir | Kunstleder
 Ecopelle



ONDA GREY

COLLECTION



URBAN BAGS

1100-753

33 x 41 x 13 cm

Tote diaper bag
Bolso panera
 Sac à langer
Wickeltasche Tote-Bag
 Borsa passeggio



1400-753

9 x 9 x 9 cm

Pacifier holder
Portachupete
 Porte sucette
Schnullertasche
 Portaciuccio



1702-753

21 x 24 x 3 cm (closed)
 58 x 44 x 3 cm (open)

Changing mat
Cambiador Bebé
 Matelas à langer
Reise-Wickelunterlage
 Fasciatoio da viaggio



1202-753

32 x 42 x 12 cm

Carry all diaper bag
Bolso maternidad
 Sac à langer en bandoulière
Wickeltasche Schultertasche
 Borsa mamma



1500-753

22 x 9 x 9 cm

Bottle holder
Portabiberón
 Porte biberon
Fläschchentasche
 Portabiberon



1900-753

19 x 30 x 8 cm

Toiletry bag
Necesar
 Trousse de toilette
Kulturbeutel
 Trousse toilette



1300-753

35 x 31 x 14 cm

Backpack diaper bag
Mochila maternal
 Sac à dos à langer
Wickeltasche Rucksack
 Zainetto mamma



1601-753

26 x 18 x 2 cm (closed)
 26 x 36 x 2 cm (open)

Document holder
Portadocumentos
 Porte-documents
Dokumententasche
 Portadocumenti



Waterproof lining | Forro interior impermeable
 Doublure intérieure imperméable | Inneres Futter wasserdicht
 Fodera interna impermeabile



Leatherette | Polipiel
 Simili-cuir | Kunstleder
 Ecopelle



ONDA ARENA

COLLECTION



URBAN BAGS

1100-710

33 x 41 x 13 cm

Tote diaper bag

Bolso panera

Sac à langer

Wickeltasche Tote-Bag

Borsa passeggio

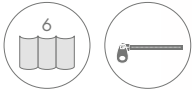

1500-710

22 x 9 x 9 cm

Bottle holder

Portabiberón

Porte biberon

Fläschchentasche

Portabiberon



1700-710

21 x 24 x 3 cm (closed)
75 x 44 x 3 cm (open)

Changing mat

Cambiador Bebé

Matelas à langer

Reise-Wickelunterlage

Fasciatoio da viaggio



1200-710

26 x 42 x 15 cm

Carry all diaper bag

Bolso maternidad

Sac à langer en bandoulière

Wickeltasche Schultertasche

Borsa mamma



1600-710

19 x 26 x 2 cm

Document holder

Portadocumentos

Porte-documents

Dokumententasche

Portadocumenti



1900-710

19 x 30 x 8 cm

Toiletry bag

Necesar

Trousse de toilette

Kulturbeutel

Trousse toilette



1300-710

35 x 31 x 14 cm

Backpack diaper bag

Mochila maternal

Sac à dos à langer

Wickeltasche Rucksack

Zainetto mamma



Leatherette

Polipiel

Simili-cuir

Kunstleder

Ecopelle



Waterproof lining

Forro interior impermeable

Doublure intérieure imperméable

Inneres Futter wasserdicht

Fodera interna impermeabile

BAROCCO

COLLECTION



URBAN BAGS

1100-782

33 x 41 x 13 cm

Tote diaper bag
Bolso panera
 Sac à langer
 Wickeltasche Tote-Bag
 Borsa passeggio

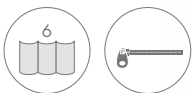

1500-782

22 x 9 x 9 cm

Bottle holder
Portabiberón
 Porte biberon
 Fläschchentasche
 Portabiberon



1700-782

21 x 24 x 3 cm (closed)
 75 x 44 x 3 cm (open)

Changing mat
Cambiador Bebé
 Matelas à langer
 Reise-Wickelunterlage
 Fasciatoio da viaggio



1200-782

26 x 42 x 15 cm

Carry all diaper bag
Bolso maternidad
 Sac à langer en bandoulière
 Wickeltasche Schultertasche
 Borsa mamma

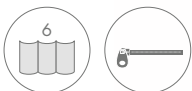

1601-782

26 x 18 x 2 cm (closed)
 26 x 36 x 2 cm (open)

Document holder
Portadocumentos
 Porte-documents
 Dokumententasche
 Portadocumenti



1900-782

19 x 30 x 8 cm

Toiletry bag
Necesar
 Trousse de toilette
 Kulturbeutel
 Trousse toilette



1300-782

35 x 31 x 14 cm

Backpack diaper bag
Mochila maternal
 Sac à dos à langer
 Wickeltasche Rucksack
 Zainetto mamma

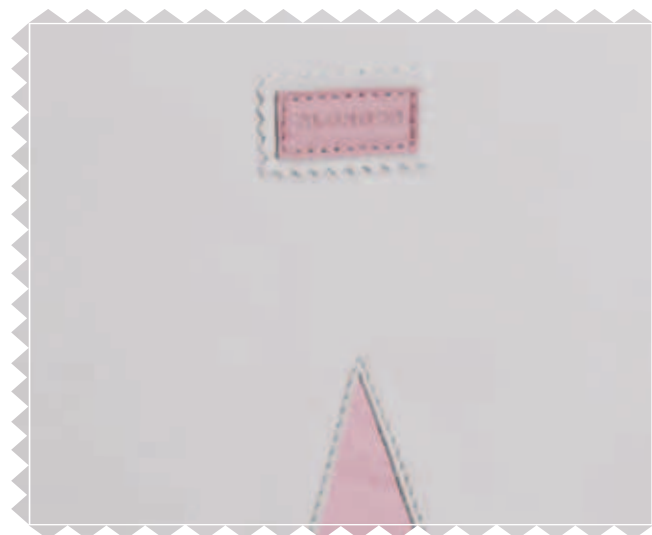

Leatherette
Polipiel
 Simili-cuir
 Kunstleder
 Ecopelle



Waterproof lining
Forro interior impermeable
 Doublure intérieure imperméable
 Inneres Futter wasserdicht
 Fodera interna impermeabile

BELLA

COLLECTION



URBAN BAGS

1100-781

33 x 41 x 13 cm

Tote diaper bag
Bolso panera
 Sac à langer
Wickeltasche Tote-Bag
 Borsa passeggio

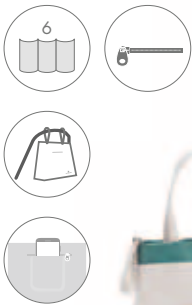

1500-781

22 x 9 x 9 cm

Bottle holder
Portabiberón
 Porte biberon
Fläschchentasche
 Portabiberon



1700-781

21 x 24 x 3 cm (closed)
 75 x 44 x 3 cm (open)

Changing mat
Cambiador Bebé
 Matelas à langer
Reise-Wickelunterlage
 Fasciatoio da viaggio



1200-781

26 x 42 x 15 cm

Carry all diaper bag
Bolso maternidad
 Sac à langer en bandoulière
Wickeltasche Schultertasche
 Borsa mamma



1601-781

26 x 18 x 2 cm (closed)
 26 x 36 x 2 cm (open)

Document holder
Portadocumentos
 Porte-documents
Dokumententasche
 Portadocumenti



1900-781

19 x 30 x 8 cm

Toiletry bag
Neceser
 Trousse de toilette
Kulturbeutel
 Trousse toilette



1300-781

35 x 31 x 14 cm

Backpack diaper bag
Mochila maternal
 Sac à dos à langer
Wickeltasche Rucksack
 Zainetto mamma

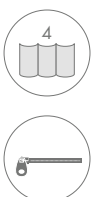

Leatherette
Polipiel
 Simili-cuir
Kunstleder
 Ecopelle



Waterproof lining
Forro interior impermeable
 Doublure intérieure imperméable
Inneres Futter wasserdicht
 Fodera interna impermeabile

OCEAN

COLLECTION



URBAN BAGS

1100-779

33 x 41 x 13 cm

Tote diaper bag
Bolso panera
 Sac à langer
 Wickeltasche Tote-Bag
 Borsa passeggio

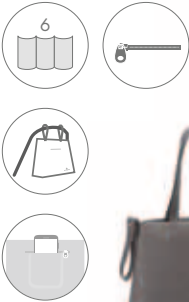

1500-779

22 x 9 x 9 cm

Bottle holder
Portabiberón
 Porte biberon
 Fläschchentasche
 Portabiberon



1700-779

21 x 24 x 3 cm (closed)
 75 x 44 x 3 cm (open)

Changing mat
Cambiador Bebé
 Matelas à langer
 Reise-Wickelunterlage
 Fasciatoio da viaggio



1200-779

26 x 42 x 15 cm

Carry all diaper bag
Bolso maternidad
 Sac à langer en bandoulière
 Wickeltasche Schultertasche
 Borsa mamma



1601-779

26 x 18 x 2 cm (closed)
 26 x 36 x 2 cm (open)

Document holder
Portadocumentos
 Porte-documents
 Dokumententasche
 Portadocumenti



1900-779

19 x 30 x 8 cm

Toiletry bag
Necesar
 Trousse de toilette
 Kulturbeutel
 Trousse toilette



1300-779

35 x 31 x 14 cm

Backpack diaper bag
Mochila maternal
 Sac à dos à langer
 Wickeltasche Rucksack
 Zainetto mamma

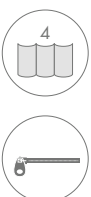

Leatherette
Polipièl
 Simili-cuir
 Kunstleder
 Ecopelle



Waterproof lining
Forro interior impermeable
 Doublure intérieure imperméable
 Inneres Futter wasserdicht
 Fodera interna impermeabile

ETNIK

COLLECTION



URBAN BAGS

NURSING CHAIRS | SILLONES DE LACTANCIA

FAUTEUILS D'ALLAITEMENT | *STILLSESSEL* | POLTRONE ALLATTAMENTO



Rocking function
Posición balancín
Position balancelle
Schaukelstuhl Position
Posizione dondolo



Fixed base. Includes 4 feet
Posición fija. Incluye 4 patas
Position fixe. Inclut 4 pieds
Sessel Position. Inklusive 4 Füße
Posizione fissa. Include 4 piedini



LEATHERETTE

Leatherette
Polipiel
Simili-cuir
Kunstleder
Ecopelle



2
USB

Includes 2 USB charging sockets
Incluye 2 tomas de USB
Inclut 2 prises USB
Inklusive 2 USB-Anschlüsse
Include 2 prese USB



LAMP

Includes LED Lamp
Incluye lámpara de LED
Inclut lampe LED
Inklusive LED Lampe
Include lampada a LED



easyclean

Easy to clean, just with water
Fácil limpieza con agua
Nettoyage facile avec de l'eau
Einfaches Reinigen mit Wasser
Facilmente lavabile con acqua



Anti-stain treatment
Tratamiento antimanchas
Traitement anti-tache
Anti-Flecken behandelt
Trattamento antimacchia

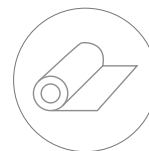

Fabric
Tela
Tissu
Stoff
Tessile



Recommended height
Altura recomendada
Hauteur conseillée
Empfohlene Größe
Altezza consigliata

NURSING CHAIRS

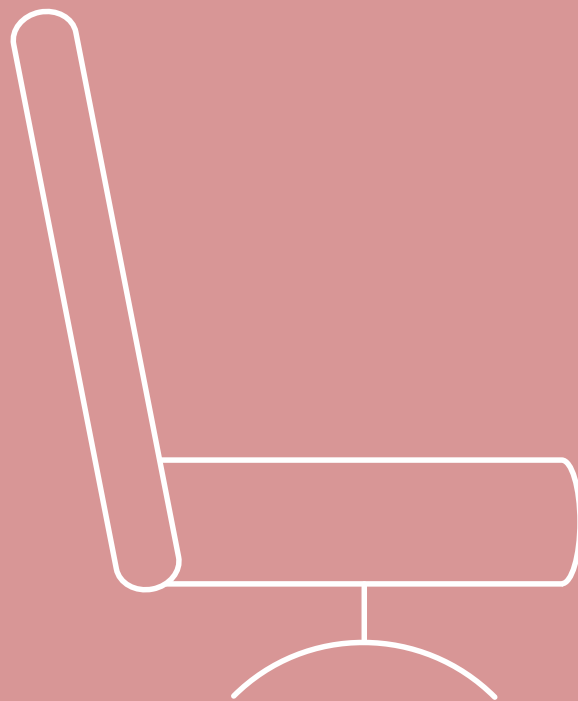

NURSING CHAIRS | SILLONES DE LACTANCIA
FAUTEUILS D'ALLAITEMENT | *STILLSESSEL* | POLTRONE ALLATTAMENTO

NURSING CHAIRS | SILLONES DE LACTANCIA
 FAUTEUILS D'ALLAITEMENT | *STILLSSEL* | POLTRONE ALLATTAMENTO

Leatherette | Polipiel | Similicuir | *Kunstleder* | Ecopelle



SL100P-P915



SL100P-P97



SL100P-P979

Leatherette | Polipiel
 Similicuir | *Kunstleder* | Ecopelle



P915



P977



P979



A0901

Leatherette | Polipiel | Similicuir | *Kunstleder* | Ecopelle



SL100A-A0901

Fabric | Tela | Tissu | Stoff | Tessile



SL100T-T923



SL100T-T939

Fabric | Tela
 Tissu | Stoff | Tessile



T923



T939

DETAILS | DETALLES | DÉTAILS | DETAILS | DETTAGLI



Rocking function
 Posición balancín
 Position balancelle
 Schaukelstuhl Position
 Posizione dondolo



Fixed base. Includes 4 feet.
 Posición fija. Incluye 4 patas.
 Position fixe. Inclut 4 pieds.
 Sessel Position. Inklusive 4 Füße.
 Posizione fissa. Include 4 piedini.

MEASURES | MEDIDAS
 MESURES | MAßE | MISURE

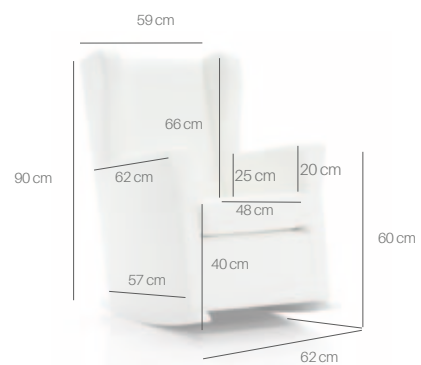

SOGNO

COLLECTION



NURSING CHAIRS

DETAILS | DETALLES
DÉTAILS | *DETAILS* | DETTAGLI



Neck pillow. Height-adjustable (magnet).
Cojín para el cuello. Ajustable en altura con imán.
Repose nuque. Réglable en hauteur (aimant).
Nackenkissen - Höhenverstellbar mit Magnet.
Cuscino poggiatesta. Regolabile in altezza con calamita.



Lumbar pillow with removable cover.
Cojín lumbar desenfundable.
Coussin lombaire déhoussable.
Rückenkissen abziehbar.
Cuscino lombare sfoderabile.



Rocking function.
Posición balancín.
Position balancelle.
Schaukelstuhl Position.
Posizione dondolo.

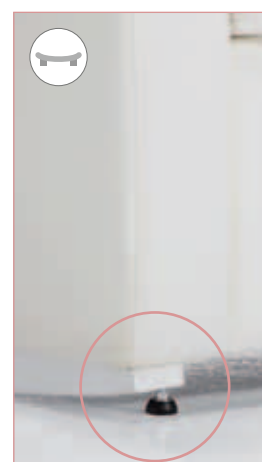

Fixed base. Includes 4 feet.
Posición fija. Incluye 4 patas.
Position fixe. Inclut 4 pieds.
Sessel Position. Inklusive 4 Füße.
Posizione fissa. Include 4 piedini.

ADDITIONAL ACCESSORIES | COMPLEMENTOS ADICIONALES
ACCESSOIRES SUPPLÉMENTAIRES | *WEITERES ZUBEHÖR* | ACCESSORI AGGIUNTIVI



Storage pocket (see "Accessories & Poufs")
Bolsillo (Ver la página "Accessories & Poufs")
Poche (voir page "Accessories & Poufs")
Seitentasche (Siehe seite "Accessories & Poufs")
Portaoggetti (vedere pagina "Accessories & Poufs")



Cushion (see "Accessories & Poufs")
Cojín (Ver la página "Accessories & Poufs")
Coussin (voir page "Accessories & Poufs")
Kissen (Siehe seite "Accessories & Poufs")
Cuscino (vedere pagina "Accessories & Poufs")



Pouf (see "Accessories & Poufs" page)
Puf (Ver la página de "Accessories & Poufs")
Pouf (voir page "Accessories & Poufs")
Sitzwürfel (Siehe seite "Accessories & Poufs")
Pouf (vedere pagina "Accessories & Poufs")

MEASURES | MEDIDAS | MESURES | MAßE | MISURE



UPHOLSTERIES | TAPIZADOS
REVÊTEMENTS | *POLSTERUNGEN*
RIVESTIMENTI

Leatherette | Polipiel
Similicuir | *Kunstleder* | Ecopelle



P915



P977



P979



A0901

Fabric | Tela
Tissu | *Stoff* | Tessile



T923



T939

NURSING CHAIRS | SILLONES DE LACTANCIA
FAUTEUILS D'ALLAITEMENT | *STILLSSEL* | POLTRONE ALLATTAMENTO

ERGO

COLLECTION



NURSING CHAIRS

NURSING CHAIRS | SILLONES DE LACTANCIA
 FAUTEUILS D'ALLAITEMENT | *STILLSESSEL* | POLTRONE ALLATTAMENTO

Leatherette | Polipiel | Similicuir | *Kunstleder* | Ecopelle



ERGO
SL101P-P915

ERGO PLUS+
SL102P-P915



ERGO
SL101P-P977

ERGO PLUS+
SL102P-P977



ERGO
SL101P-P979

ERGO PLUS+
SL102P-P979

Leatherette | Polipiel | Similicuir | *Kunstleder* | Ecopelle



ERGO
SL101A-A901

ERGO PLUS+
SL102A-A901



ERGO
SL101T-T923

ERGO PLUS+
SL102T-T923



ERGO
SL101T-T939

ERGO PLUS+
SL102T-T939

2
SIZES

ERGO COLLECTION

ERGO

ERGO PLUS +



ERGO
Recommended. Less than 175 cm height.
Recomendado. Altura inferior a 175 cm.
Recommandé. Moins de 175 cm de hauteur.
Empfohlen bei einer Größe unter 175 cm.
Consigliato. Meno di 175 cm di altezza.

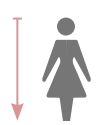

ERGO PLUS +
Recommended. More than 175 cm height.
Recomendado. Altura superior a 175 cm.
Recommandé. Supérieur à 175 cm de hauteur.
Empfohlen bei einer Größe ab 175 cm.
Consigliato. Superiore a 175 cm di altezza.

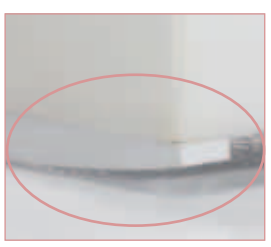

Rocking function.
Posición balancín.
Position balancelle.
Schaukelstuhl Position.
Posizione dondolo.

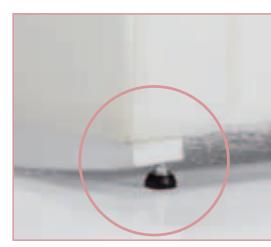

Fixed base. Includes 4 feet.
Posición fija. Incluye 4 patas.
Position fixe. Includ 4 pieds.
Sessel Position. Inklusive 4 Füße.
Posizione fissa. Include 4 piedini.

NURSING CHAIRS | SILLONES DE LACTANCIA
 FAUTEUILS D'ALLAITEMENT | *STILLESSEL* | POLTRONE ALLATTAMENTO

Leatherette | Polipiel | Similicuir | *Kunstleder* | Ecopelle



ERGO LUXE
SL111P-P915



ERGO LUXE PLUS +
SL112P-P915



ERGO LUXE
SL111P-P979

ERGO LUXE
SL111P-P977

ERGO LUXE PLUS +
SL112P-P977

ERGO LUXE PLUS +
SL112P-P979

DETAILS | DETALLES | DÉTAILS | DETAILS | DETTAGLI

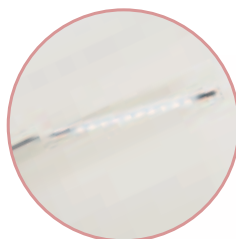

LED Lamp
Lámpara de LED
Lampe LED
LED Lampe
Lampada a LED



2 USB charging sockets
2 tomas de USB
2 prises USB
2 USB-Anschlüsse
2 prese USB



Includes transformer
Incluye transformador
Inclut transformateur
Inklusive Transformator
Include trasformatore



Neck pillow. Height adjustable (magnet).
Cojín para el cuello. Ajustable en altura con imán.
Repose nuque. Réglable en hauteur (aimant).
Nackenkissen - Höhenverstellbar mit Magnet.
Cuscino poggiatesta. Regolabile in altezza con calamita.

Lumbar pillow with removable cover.
Cojín lumbar desenfundable.
Coussin lombaire déhoussable.
Rückenkissen abziehbar.
Cuscino lombare sfoderabile.

2 positions | 2 posiciones | 2 positions | 2 Positionen | 2 posizioni



Rocking function.
Posición balancín.
Position balancelle.
Schaukelstuhl Position.
Posizione dondolo.



Fixed base. Includes 4 feet.
Posición fija. Incluye 4 patas.
Position fixe. Inclut 4 pieds.
Sessel Position. Inklusive 4 Füße.
Posizione fissa. Include 4 piedini.

Leatherette | Polipiel
Similicuir | *Kunstleder* | Ecopelle



P915



P977



P979

Measures | Medidas
Mesures | *Maße* | Misure

2 SIZES

ERGO LUXE

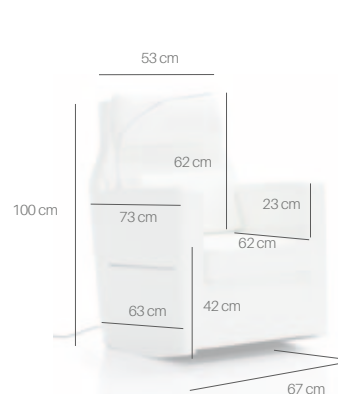

ERGO LUXE PLUS +

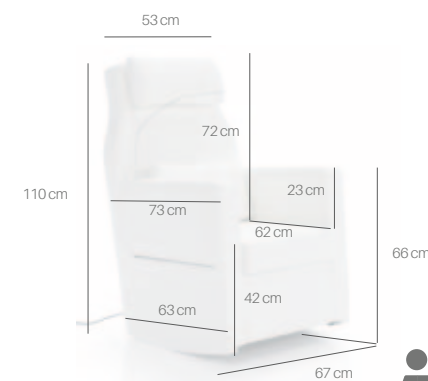

Recommended
+175 cm



ERGO LUXE

COLLECTION



2
SIZES



NURSING CHAIRS

ACCESSORIES AND POUFS | ACCESORIOS Y PUFOS
 ACCESSOIRES ET POUFS | EXTRAS UND SITZWÜRFEL | ACCESSORI E PUFF

Poufs | Pufs | Poufs | Sitzwürfel | Puff



SP105P-P915



SP105P-P977



SP105P-P979



SP105A-A901



SP105T-T923



SP105T-T939

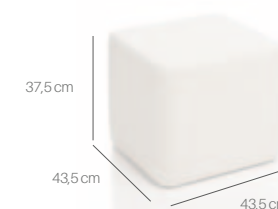

Storage pocket for nursing chair | Bolsillos para sillón de lactancia
 Poche pour fauteuil d'allaitement | Seitentasche für Stillsessel | Tasca portaoggetti per poltrona allattamento



SB106P-P915



SB106P-P977



SB106P-P979



SB106T-T923



SB106T-T939

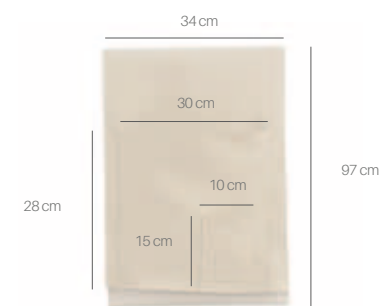

Leatherette cushion | Cojín Polipiel
 Coussin simili-cuir | Kunstleder Kissen | Cuscino ecopelle



SC107P-P778



SC107P-P779



SC107P-P781



SC107P-P782



ACCESSORIES & POUFS



NURSING CHAIRS

LAMPS | LÁMPARAS | LAMPES | LAMPEN | LAMPADE



Includes 12V transformer for increased safety
Incluye transformador de 12V para mayor seguridad
Transformateur 12V inclus pour plus de sécurité
Aus Sicherheitsgründen Transformator 12V inklusive
Include un trasformatore di 12V per maggiore sicurezza

Max.
240 V

Use 100-240V light bulbs
Usar bombillas de 100-240V
Utiliser des ampoules de 100-240V
Glühbirnen 100-240V benutzen
Usare lampadine da 100-240V



Light bulb included
Bombilla incluida
Ampoule incluse
Inklusive Glühbirne
Lampadina inclusa

12V

Only use 12V light bulbs
Usar sólo bombillas de 12V
N'utiliser que des ampoules de 12V
Ausschließlich 12V Glühbirnen benutzen
Usare solo lampadine da 12V



Light bulb not included
Bombilla no incluida
Ampoule pas incluse
Glühbirne nicht inklusive
Lampadina non inclusa

E27

Includes fitting for E27 light bulbs
Incluye portalámparas con rosca E27
Inclut douille électrique à vis E27
Inklusive Lampensockel mit E27 Gewinde
Include un portalampade con filetto E27



Magnetic attachment system
Sistema de fijación con imán
Système de fixation magnétique
Halterung mit Magnet
Sistema di aggancio con calamita

3W

Use light bulbs up to 3W
Usar bombillas de máximo 3W
Utiliser des ampoules jusqu'à 3W
Glühbirnen mit max. 3W benutzen
Usare lampadine da max. 3W



Cable length
Longitud de cable
Longueur du cable
Kabellänge
Lunghezza del cavo

max.
20 W

Use light bulbs up to 20W
Usar bombillas de máximo 20W
Utiliser des ampoules jusqu'à 20W
Glühbirnen mit max. 20W benutzen
Usare lampadine da max. 20W

NOTE: All lamps can be used with 100-240V electrical installations

NOTA: Todas las lámparas se pueden conectar a instalaciones de 100-240V

NOTE: Toutes les lampes peuvent être branchées sur du 100-240V

ANMERKUNG: Alle Lampen können an Installationen von 100-240V angeschlossen werden

NOTA: Tutte le lampadine possono essere collegate ad impianti da 100-240V

LAMPS | LÁMPARAS | LAMPES | LAMPEN | LAMPADE

Pendant light | Lámpara de techo | Suspension | Hängelampe | Lampadario

20 x 40 x 40 cm

Max.
240 V



75 cm



L539-1400



L539-2300

Recommended:

1 x E27 max 20 W

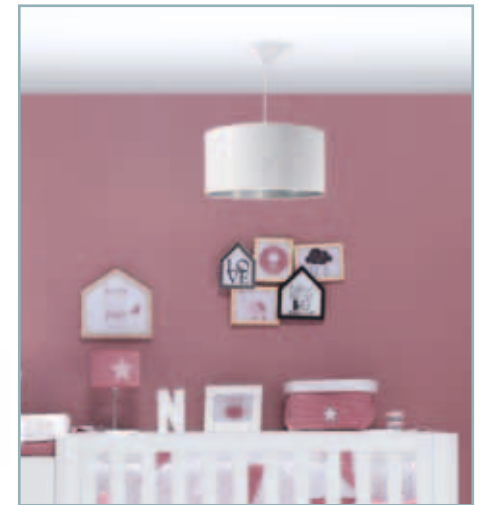
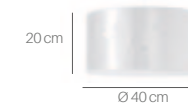

Table lamp | Lámpara de sobremesa | Lampe de chevet | Nachttischlampe | Lampada da tavolo

33,5 x 20 x 20 cm

125 cm



LS537-1400



LS537-2300



Max.
240 V

Not included



12V



Included

Child safe

L537-1400

L537-2300

LS537

Recommended:

1 x E27 max 20 W

L537

Included:

1 x E27 3W 12V

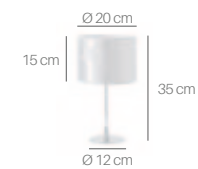

Floor lamp | Lámpara de pie | Lampadaire | Stehlampe | Lampada piantana

146 x 40 x 40 cm

Max.
240 V



205 cm



L538-1400



L538-2300

Recommended:

1 x E27 max 20 W

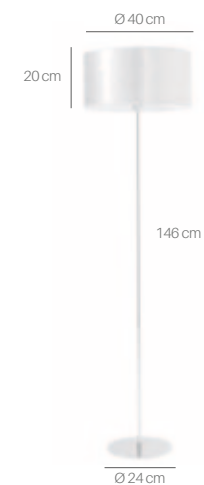

SHINE
COLLECTION



NURSERY LIGHTING

LAMPS | LÁMPARAS | LAMPES | LAMPEN | LAMPADE

Pendant light | Lámpara de techo | Suspension | Hängelampe | Lampadario

20 x 40 x 40 cm

Max.
240 V



75 cm



L597T-0153

L597T-0178

L597T-7900

L597T-8100

L597T-8200

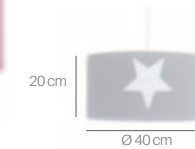

Recommended:
1 x E27 max. 20 W

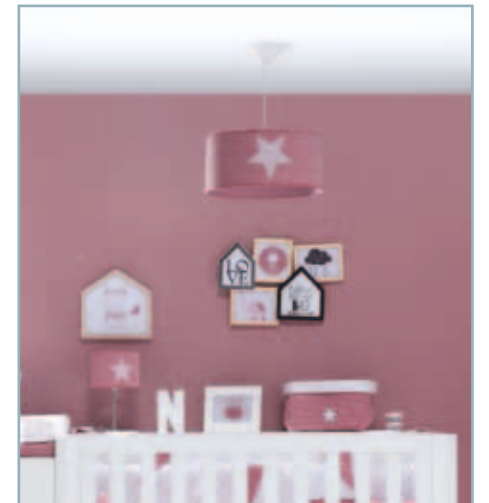

Table lamp | Lámpara de sobremesa | Lampe de chevet | Nachttischlampe | Lampada da tavolo

33,5 x 20 x 20 cm

125 cm



Max.
240 V

Not included



LS597M-0153

LS597M-0178

LS597M-7900

LS597M-8100

LS597M-8200

LS590M
Recommended:
1 x E27 max. 20 W

LS590M
Included:
1 x E27 3 W 12 V

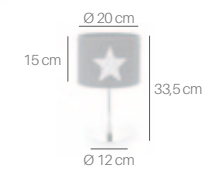

Included

12V



Child safe

L597M-0153

L597M-0178

L597M-7900

L597M-8100

L597M-8200

Floor lamp | Lámpara de pie | Lampadaire | Stehlampe | Lampada piantana

146 x 40 x 40 cm

Max.
240 V



205 cm



L597S-0153

L597S-0178

L597S-7900

L597S-8100

L597S-8200

Recommended:
1 x E27 max. 20 W

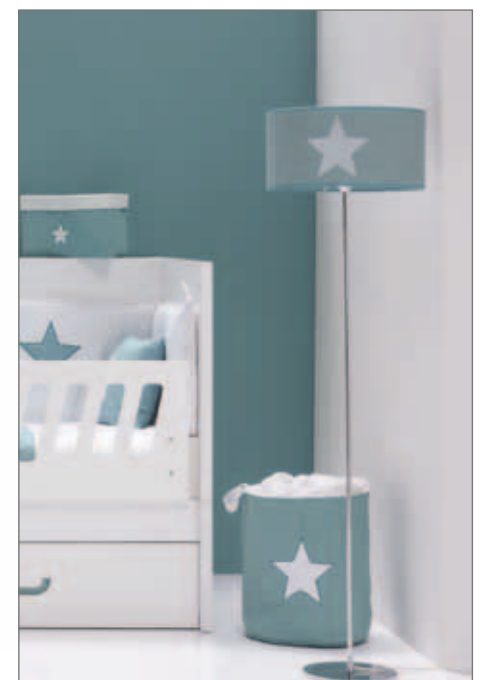
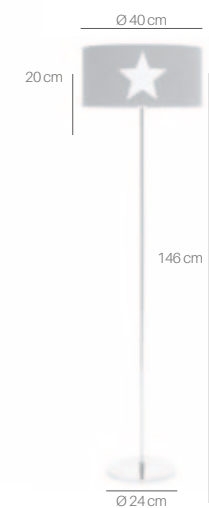

STELLA

COLLECTION



NURSERY LIGHTING

LAMPS | LÁMPARAS | LAMPES | LAMPEN | LAMPADE

Pendant light | Lámpara de techo | Suspension | Hängelampe | Lampadario

20 x 40 x 40 cm

Max.
240 V



75 cm



L534-2070



L534-3070

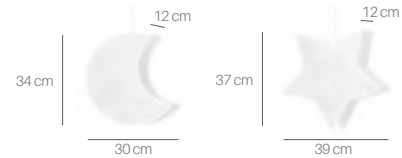

Recommended:

1 x



Table lamp | Lámpara de sobremesa | Lampe de chevet | Nachttischlampe | Lampada da tavolo

33,5 x 20 x 20 cm

125 cm



LS532-2070



LS532-3070

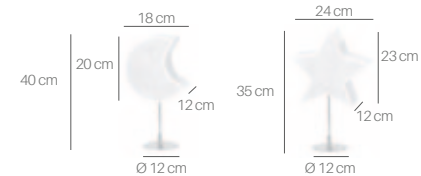

LS532

Recommended:

1 x

L532

Included:

1 x



Not included

Included

12V

Child safe

L532-2070

L532-3070

Floor lamp | Lámpara de pie | Lampadaire | Stehlampe | Lampada piantana

146 x 40 x 40 cm

Max.
240 V



205 cm



L533-2070



L533-3070

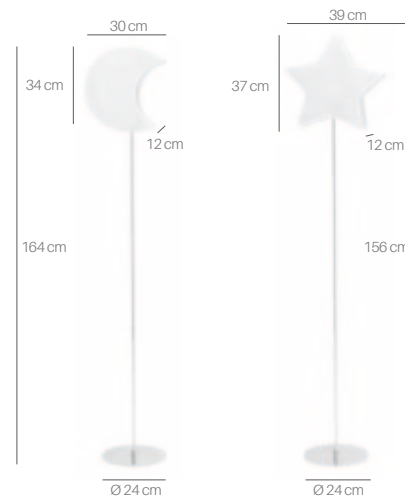

Recommended:

1 x

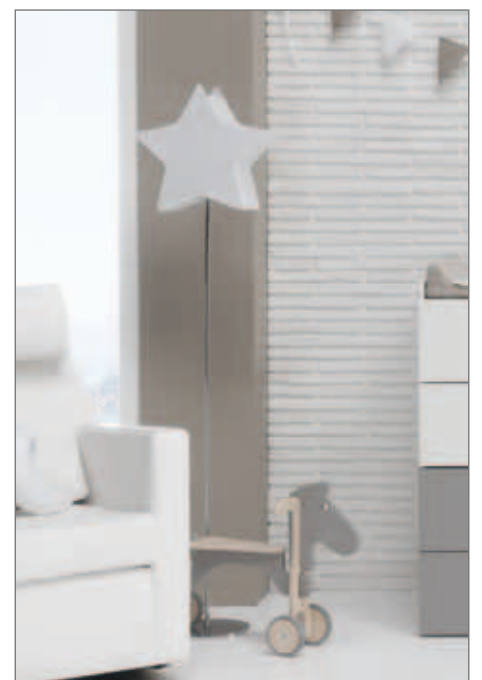

DREAMS

COLLECTION



NURSERY LIGHTING

LAMPS | LÁMPARAS | LAMPES | LAMPEN | LAMPADE

Ceiling lamp | Lámpara de techo | Suspension | Deckenlampe | Lampadario

15 x 40 x 40 cm

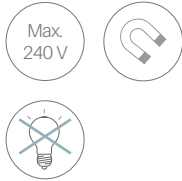

L591T-5100



L591T-5300



L591T-7800



L591T-8100



L591T-8200

Recommended:

1 x E27 (max. 20 W)



Wall lamp | Lámpara de pared | Applique murale | Wandlampe | Lampada applique

40 x 40 x 15 cm

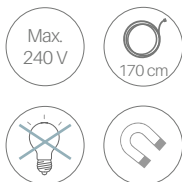

L591P-5100



L591P-5300



L591P-7800



L591P-8100



L591P-8200

Recommended:

1 x E27 (max. 20 W)



Table lamp | Lámpara de sobremesa | Lampe de chevet | Nachttischlampe | Lampada da tavolo

35 x 14 x 14 cm



LS591M-5100



LS591M-5300



LS591M-7800



LS591M-8100



LS591M-8200



LS591M-0179

LS591M

Recommended:

1 x E27 (max. 20 W)

LS591M

Included:

1 x E27

3 W 12 V

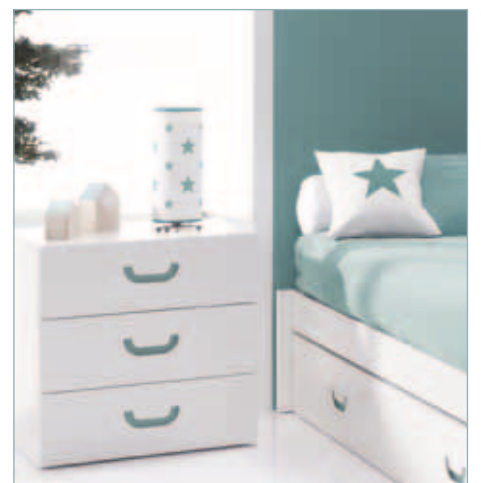

Floor lamp | Lámpara de pie | Lampadaire | Stehlampe | Lampada da terra

141,5 x 20 x 20 cm

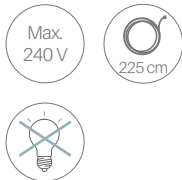

L591S-5100



L591S-5300



L591S-7800



L591S-8100



L591S-8200



L591S-0179

Recommended:

3 x E27 (max. 20 W)

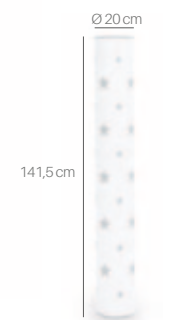

NOTTE

COLLECTION



NURSERY LIGHTING

LAMPS | LÁMPARAS | LAMPES | LAMPEN | LAMPADE

Wall lamp | Lámpara de pared | Applique murale | Wandlampe | Lampada applique

28 x 28 x 13 cm

Max.
240 V



175 cm



L599P-7700

Recommended:

1 x E27 max. 20 W

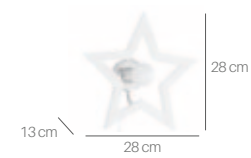

Table lamp | Lámpara de sobremesa | Lampe de chevet | Nachttischlampe | Lampada da tavolo

42 x 29 x 12 cm

115 cm

Max.
240 V

Not included

12V

Included



Child safe

LS599M-7700

L599M-7700



LS599M

Recommended:

1 x E27 max. 20 W

L599M

Included:

1 x E27 3W 12V

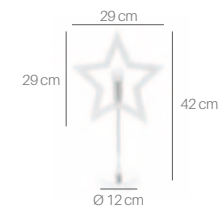

Pendant light | Lámpara de techo | Suspension | Hängelampe | Lampadario

52 x 52 cm

Max.
240 V



100 cm



L599T-7700

Recommended:

1 x E27 max. 20 W



MDF star | Estrella en MDF
Étoile en MDF | Stern aus MDF | Stella in MDF

VOLARE

COLLECTION



NURSERY LIGHTING

ACCESSORIES & DECO | ACCESORIOS Y DECORACIÓN
ACCESSOIRES ET DÉCORATION | *ZUBEHÖR UND DEKORATION*
ACCESSORI E DECORAZIONI

ACCESSORIES & DECO



ACCESSORIES & DECO | **ACCESORIOS Y DECORACIÓN** | **ACCESSOIRES ET DÉCORATION**
ZUBEHÖR UND DEKORATION | *ACCESSORI E DECORAZIONI*

Body-adaptable memory foam mattress.

Body-adaptable.
Memory foam is a material that adapts to the baby's or child's body and relieves any type of pressure on the body during sleep.

Hygiene and comfort.
The mattress composition ensures maximum comfort, breathability and durability. Hypoallergenic and dust mite resistant.

Soft cover.
The mattress cover has a lovely soft feel. Made of OEKO-TEX® Standard 100 stretch fabric.

Removable and washable cover.
Easy-clean. The mattress features a cover that can be easily taken off by undoing the zipper.

Colchón de viscoelástica adaptable, para el correcto descanso del bebé.

Adaptable.
Fabricado con viscoelástica, material que se adapta al cuerpo del bebé o niño evitando cualquier punto de presión durante el descanso.

Higiene y confort.
La composición del colchón asegura la máxima comodidad, transpirabilidad y duración del mismo. Incorpora tratamientos anti ácaros para evitar alergias.

Tejido suave.
El tejido exterior del colchón ofrece una agradable sensación de suavidad. Compuesto por tejido "Stretch" certificado OEKO-TEX® estándar 100.

Desenfundable y lavable.
Colchón higiénico. Fácil de desenfundar gracias a la cremallera perimetral que incorpora.

Matelas en mousse viscoélastique adaptable.

Adaptable.
Fabriqué en mousse à mémoire de forme, qui s'adapte à la morphologie du corps du bébé ou de l'enfant, allégeant ainsi les points de pression pendant le sommeil.

Hygiénique et confortable.
La composition du matelas assure son confort, transpirabilité et durabilité. Traité contre les acariens afin d'éviter des allergies.

Tissu doux.
La housse du matelas offre une sensation douce et moelleuse. Housse en tissu "Stretch" certifié OEKO-TEX® Standard 100.

Matelas déhoussable.
Hygiénique et facile d'entretien. Housse amovible à fermeture éclair et lavable.

Matratze aus Viscoschaum, für den gesunden Schlaf des Kindes.

Anpassung.
Hergestellt aus Viscoschaum. Dieses Material passt sich perfekt an dem Körper des Kindes an, ohne jeglichen Druckpunkte zu verursachen.

Hygiene und Komfort.
Die Zusammensetzung der Matratze garantiert maximalen Komfort, beste Belüftung und eine lange Nutzung. Die Matratze wurde gegen Milben behandelt und ist somit für Allergiker geeignet.

Weicher Stoff.
Der äussere Stoff der Matratze, hergestellt nach OEKO-TEX® Standard 100, ist angenehm weich.

Abzieh- und waschbar.
Der Matratzenbezug ist mit einem Reißverschluss versehen und kann abgezippt werden.

Materasso anatomico viscoelastico, per un sano e corretto riposo del bimbo.

Anatomico.
Prodotto in schiuma viscoelastica, materiale che con il calore prende la forma del corpo del bimbo evitando qualsiasi punto di pressione durante il riposo.

Igiene e confort.
La composizione del materasso garantisce la massima comodità, traspirabilità e durata dello stesso. Il trattamento antiacaro previene eventuali reazioni allergiche.

Morbido tessuto.
Il tessuto esterno del materasso offre una gradevole sensazione di morbidezza. Prodotto in tessuto "Stretch" certificato OEKO-TEX® standard 100.

Sfoderabile e lavabile.
Materasso igienico. Facile da sfoderare grazie alla pratica chiusura zip perimetrale.

Reference
Referencia
Référence
Referenz
Riferimento

Bed / cot size
Medidas cuna / cama
Mesures du lit bébé / junior
Maße Baby-/Jugendbett
Misure lettino / letto

Mattress size
Medidas del colchón
Mesures du matelas
Maße Matratze
Misure materasso

ZC90-200



90x200 cm

90x200x22 cm

ZN90-190



90x190 cm

90x190x15 cm

ZV60-120



60x120 cm

58x118x12 cm

ZV70-140



70x140 cm

68x138x12 cm

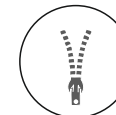
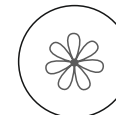
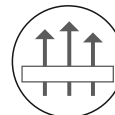
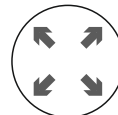

Rolled up for easier transport
Enrollado para facilitar el transporte
Enroulé pour un transport facile
Gerollt für einfachen Transport
Arrotolato per facilitarne il trasporto



MEMORY VISCO

MATTRESSES

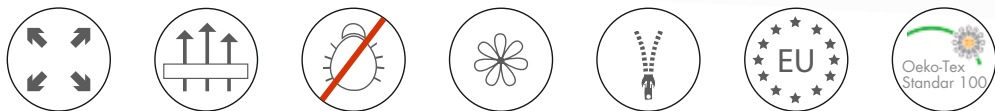

DECO & ACCESORIES

Organic mattress for babies made with soybean oil.

Organic cotton fabric.
Certified "Organic Cotton", which attests that the mattress on which the baby lies has been manufactured with cotton grown under organic farming methods, free of pesticides and other harmful substances.

Prevents SIDS.
Mattress designed based on recommendations to prevent SIDS.

Bio core.
Made from natural soybean oil, more respectful towards the environment.

Breathable to ensure maximum hygiene.
Its ventilation channels keep the baby fresh and dry. Easy to clean. Its all-around zipper allows the cover to be removed and washed easily without losing its properties.

Colchón orgánico para bebés elaborado con aceites naturales de soja.

Tejido de algodón orgánico.
Certificado "Organic Cotton" que garantiza que el tejido con el que está fabricado el colchón es natural, procedente de cultivo de algodón ecológico, libre de pesticidas y sustancias nocivas para la salud del bebé.

Prevención muerte súbita.
Colchón especialmente diseñado para prevenir la muerte súbita del lactante, siguiendo todas las recomendaciones de los expertos.

Núcleo Bio.
Fabricado con aceites naturales de soja. Por su composición natural es más respetuoso con el medio ambiente y garantiza una mayor suavidad para el descanso.

Transpirable e higiénico.
Los canales de aireación en ambos lados del colchón ofrecen la máxima transpiración y frescura para el descanso del bebé. Desenfundable y de fácil lavado gracias a la cremallera perimetral que incorpora para poder separar cada una de las piezas.

Matelas organique pour bébé fabriqué à partir d'huile de soja naturelle.

Tissu en coton BIO.
Certification "Coton Biologique" garantissant que le matelas sur lequel bébé dormira est produit en coton issu de l'agriculture biologique, sans l'utilisation de pesticides ou d'autres substances pernicieuses.

Prévention morte subite du nourrisson.
Matelas conçu en suivant les recommandations pour réduire le risque du syndrome de mort subite du nourrisson.

Noyau Bio.
Fabriqué à partir d'huile de soja naturelle, plus respectueux de l'environnement.

Transpirable pour une hygiène parfaite.
Système de ventilation pour que bébé soit toujours frais et sec. Facile à nettoyer. Sa fermeture éclair tout autour permet de laver la housse séparément tout en conservant ses propriétés.



Rolled up for easier transport
Enrollado para facilitar el transporte
 Enroulé pour un transport facile
 Gerollt für einfachen Transport
 Arrotolato per facilitarne il trasporto

Organische Matratze für Babys, hergestellt mit Sojaöl.

Stoff aus Bio-Baumwolle.
Das Gütesiegel "kba" garantiert, dass der Stoff aus kontrolliert ökologischem Anbau stammt und frei von jeglichen Pestiziden und Schadstoffen ist.

Vorbeugung des plötzlichen Kindstodes.
Matratze entworfen entsprechend Empfehlungen zur Vorbeugung des plötzlichen Kindstodes.

Biokern.
Hergestellt mit umweltschonenden Sojaölen.

Atmungsaktiv und hygienisch.
Eingebaute Luftkanäle, damit das Baby immer frisch und trocken schläft. Einfache Reinigung. Durch den rundherumgehenden Reissverschluss kann die Hülle einfach abgezogen werden.

Materasso in Bio Soia per bambini prodotto con oli essenziali di soia.

Tessuto in cotone organico.
Certificato "Organic Cotton" che permette al bimbo di dormire su un materasso rivestito in morbido cotone naturale derivante da coltivazioni ecologiche, prive di pesticidi e di sostanze nocive.

Prevenzione della morte improvvisa.
Materasso progettato secondo le raccomandazioni per prevenire la morte improvvisa del lattante.

Nucleo in Bio Soia.
Prodotto con oli essenziali di soia di origine vegetale, rispettando la natura.

Massima traspirabilità ed igiene.
I suoi canali di aerazione mantengono il bimbo sempre fresco e asciutto. Lavaggio facile, la sua chiusura lampo perimetrale consente il lavaggio di ogni singolo componente senza che essi perdano le loro proprietà.

Reference
Referencia
 Référence
 Referenz
 Riferimento

Cot size
Medidas cuna
 Mesures du lit bébé
 Maße Babybett
 Misure lettino

Mattress size
Medidas del colchón
 Mesures du matelas
 Maße Matratze
 Misure materasso

ZR60-120



60 x 120 cm

58 x 118 x 12 cm

ZR70-140



70 x 140 cm

68 x 138 x 12 cm

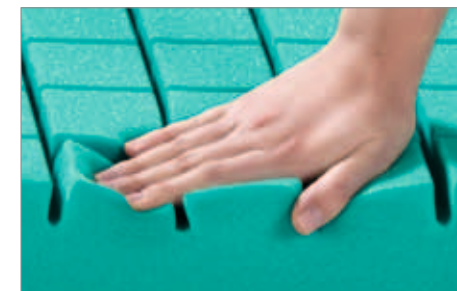
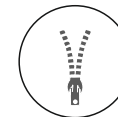
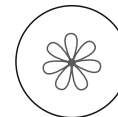
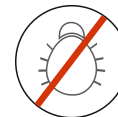
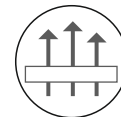

ORGANIC SOJA

MATTRESSES

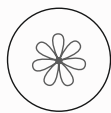
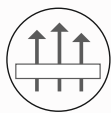

DECO & ACCESORIES

MODULAR CHEST | CÓMODA MODULAR

COMMODE MODULAIRE | MODULARE KOMMODE | CASSETTIERA MODULARE



D201C

↑ 88,3 cm → 47 cm ↻ 48,8 cm

Modular chest with 4 drawers (without countertop)

Cómoda modular con 4 cajones (sin tapa)

Commode modulaire avec 4 tiroirs (sans partie supérieure)

Modulare Kommode mit 4 Schubladen (ohne Abdeckplatte)

Cassettiera modulare con 4 cassetti (senza copertura)

D201C-G2300

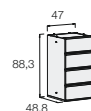

D201E

↑ 88,3 cm → 47 cm ↻ 48,8 cm

Modular chest with 2 shelves (without countertop)

Cómoda modular con 2 estantes (sin tapa)

Commode modulaire avec 2 étagères (sans partie supérieure)

Modulare Kommode mit 2 Einlegeböden (ohne Abdeckplatte)

Cassettiera modulare con 2 ripiani (senza copertura)

D201E-G2300

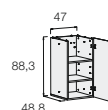

WT201 / WT201L

↑ 1,9 cm → 47 cm ↻ 47 cm

Countertop for 1 module

Tapa para 1 módulo de cómoda

Partie supérieure pour commodes de 1 module

Abdeckplatte für 1 Modul

Copertura per 1 modulo cassettiera

WT201-G30

WT201L-G2300

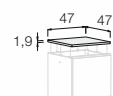

WT202 / WT202L

↑ 1,9 cm → 94 cm ↻ 47 cm

Countertop for 2 modules

Tapa para 2 módulos de cómoda

Partie supérieure pour commodes de 2 modules

Abdeckplatte für 2 Module

Copertura per 2 moduli cassettiera

WT202-G30

WT202L-G2300

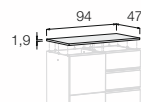

WT203 / WT203L

↑ 1,9 cm → 141 cm ↻ 47 cm

Countertop for 3 modules

Tapa para 3 módulos de cómoda

Partie supérieure pour commodes de 3 modules

Abdeckplatte für 3 Module

Copertura per 3 moduli cassettiera

WT203-G30

WT203L-G2300

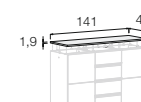

In order to build any modular chest (D201C and D201E), it is necessary to purchase a countertop depending on the number of modules (available for 1, 2 and 3 modules). The price of the chest does not include the top.

Para comprar cualquier módulo de cómoda modular D201C y D201E se deberá pedir necesariamente la tapa/encimera según los módulos que desee, disponible para 1, 2 y 3 módulos. El precio del módulo no incluye el de la tapa/encimera.

Pour compléter les modules D201C et D201E, il faudra rajouter la planche supérieure. Disponible pour 1, 2 et 3 modules. La planche supérieure n'est pas incluse dans le prix du module.

Für jede modulare Kommode (D201C und D201E) muss immer eine obere Abdeckplatte gekauft werden (verfügbar für 1, 2, 3 Module). Der Preis der Kommode schließt die Abdeckplatte nicht.

Per comporre una cassettiera modulare con i moduli D201C e D201E, si dovrà acquistare necessariamente l'apposito pannello/copertura, disponibile per 1, 2 o 3 moduli, in base alla composizione che si vuole fare. Il pannello/copertura non è compreso nel prezzo del modulo.



The modular chests include small adjustable feet, which allow to even the chest when placed on uneven floors (min 7mm - max. 11mm).

Las cómodas modulares incorporan un sistema de pequeñas patas regulables en altura que permite nivelar la cómoda cuando se colocan sobre suelos irregulares (evitando también futuros problemas de humedad). Mín. 7mm - Máx. 11mm.

La commode modulaire inclut un système de petits pieds réglables (min. 7mm - max. 11mm), qui permettent de niveler la commode si le sol n'est pas complètement droit.

Die modulare Kommode integriert kleine anpassbare Füße, die eine Nivellierung der Kommode ermöglichen (7mm min - max. 11mm).

Le cassettiere modulari includono un sistema di piedini regolabili in altezza che permettono di livellarle quando il pavimento presenta delle irregolarità, aumentando la sua altezza di un minimo di 7 mm (evitando inoltre eventuali accumuli di umidità). Min. 7 mm. - Max. 11 mm.

MODULAR SYSTEM

ACCESSORIES | ACCESORIOS | ACCESSOIRES | ZUBEHÖR | ACCESSORI

GLOSS
FINISH



DECO & ACCESORIES

MODULAR WARDROBE | ARMARIO MODULAR
 ARMOIRE MODULAIRE | MODULARSCHRANK | ARMADIO MODULARE

A301B

↑ 100 cm → 50 cm ↻ 59,8 cm

Modular wardrobe with hanging rod
 Armario modular con barra para colgar
 Armoire modulaire avec penderie
 Modulschränk mit Kleiderstange
 Armadio modulare con barra appendiabiti

▢ A301B-G2300

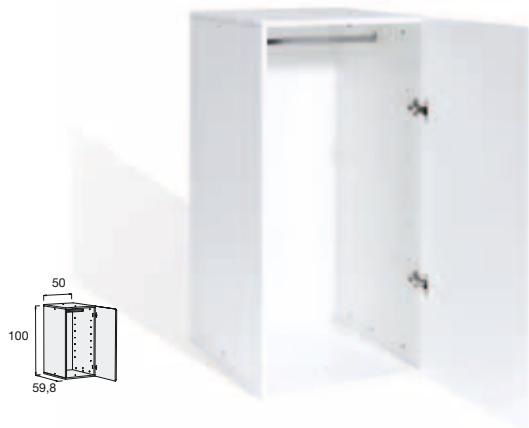

A301C

↑ 100 cm → 50 cm ↻ 59,8 cm

Modular wardrobe with 4 drawers
 Armario modular con 4 cajones
 Armoire modulaire avec 4 tiroirs
 Modulschränk mit 4 Schubladen
 Armadio modulare con 4 cassetti

▢ A301C-G2300

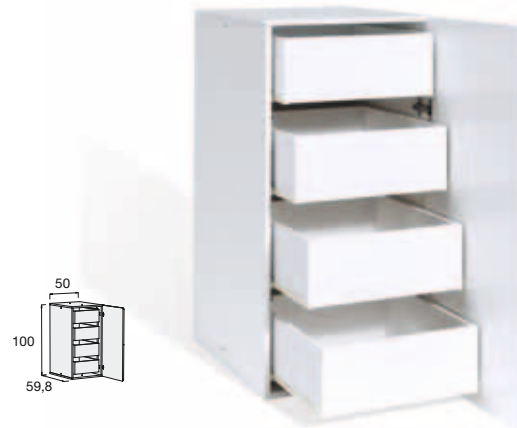

A301E

↑ 100 cm → 50 cm ↻ 59,8 cm

Modular wardrobe with 2 shelves
 Armario modular con 2 estantes regulables
 Armoire modulaire avec 2 étagères
 Modulschränk mit 2 Einlegeböden
 Armadio modulare con 2 ripiani

▢ A301E-G2300



A301D

↑ 200 cm → 50 cm ↻ 59,8 cm

Double-height modular wardrobe with hanging rod and 2 shelves
 Armario modular de doble altura con barra y 2 estantes regulables
 Armoire modulaire double hauteur avec penderie et 2 étagères
 Modulschränk mit Kleiderstange und 2 Einlegeböden, doppelte Höhe
 Armadio modulare doppia altezza con barra appendiabiti e 2 ripiani

▢ A301D-G2300



2 separate doors | 2 puertas independientes
 2 portes séparées | mit 2 Türen | 2 ante indipendenti

A301R

↑ 200 cm → 95 cm ↻ 95 cm

Double-height corner modular wardrobe with 2 shelves
 Armario modular rinconera de doble altura con 2 estantes
 Armoire modulaire d'encoignure avec 2 étagères
 Modular-Eckschränk mit 2 Einlegeböden, doppelte Höhe
 Armadio modulare angolare doppia altezza con 2 barre appendiabiti e 2 ripiani

▢ A301R-G2300



2 separate doors | 2 puertas independientes
 2 portes séparées | mit 2 Türen | 2 ante indipendenti

GLOSS
FINISH

MODULAR SYSTEM

A301BB

↑ 100 cm → 100 cm ↻ 59,8 cm

Double-width modular wardrobe with hanging rod

Armario modular doble ancho con barra para colgar

Armoire modulaire double largeur avec penderie

Modularschrank mit Kleiderstange, doppelte Breite

Armadio modulare doppia larghezza con barra appendiabiti

A301BB-G2300

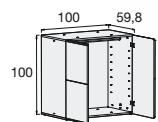

A301EE

↑ 100 cm → 100 cm ↻ 59,8 cm

Double-width modular wardrobe with 2 shelves

Armario modular doble ancho con 2 estantes regulables

Armoire modulaire double largeur avec 2 étagères

Modularschrank mit 2 Einlegeböden, doppelte Breite

Armadio modulare doppia larghezza con 2 ripiani

A301EE-G2300

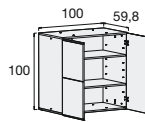

A301WD

↑ 50 cm → 100 cm ↻ 59,8 cm

Double-width upper cabinet module with shelf

Altillo modular doble ancho con estante

Armoire haute modulaire double largeur avec étagère

Hochschrank für Modularschrank mit Einlegeboden, doppelte Breite

Sopralzo modulare doppia larghezza con ripiano

A301WD-G2300

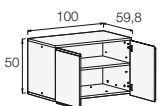

A301WR

↑ 50 cm → 95 cm ↻ 95 cm

Corner upper cabinet module

Altillo modular rinconera

Armoire haute modulaire d'encoignure

Hochschrank für Modular-Eckschrank

Sopralzo modulare angolare

A301WR-G2300

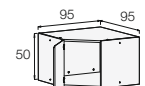

A301W

↑ 50 cm → 50 cm ↻ 59,8 cm

Upper cabinet module (height 50 cm) with shelf

Altillo modular (50 cm altura) con estante

Armoire haute modulaire avec étagère (hauteur 50 cm)

Hochschrank für Modularschrank mit Einlegeboden (Höhe 50 cm)

Sopralzo modulare con ripiano (altezza 50 cm)

A301W-G2300

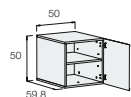

A301WL

↑ 40 cm → 50 cm ↻ 59,8 cm

Upper cabinet module (height 40 cm) with shelf

Altillo modular (40 cm altura) con estante

Armoire haute modulaire avec étagère (hauteur 40 cm)

Hochschrank für Modularschrank mit Einlegeboden (Höhe 40 cm)

Sopralzo modulare con ripiano (altezza 40 cm)

A301WL-G2300

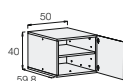

A301 modular wardrobe incorporates small adjustable feet, which allow evening the wardrobe when placed on uneven floors. 7mm Min - Max. 11mm.

Los armarios modulares A301 incorporan un sistema de pequeñas patas regulables en altura que permite nivelar el armario cuando se colocan sobre suelos irregulares (evitando también futuros problemas de humedad). Min. 7mm - Máx. 11mm.

Système de petits pieds réglables inclus dans les armoires modulaires A301. Min. 7mm - Max. 11mm, qui permettent de niveler l'armoire si le sol n'est pas complètement droit.

Der modulare Schrank A301 integriert kleine anpassbare Beine, die eine Nivellierung des Schrankes ermöglichen. 7 mm min - Max. 11 mm.

Gli armadi modulari includono un sistema di piedini regolabili in altezza che permettono di livellarle quando il pavimento presenta delle irregolarità, aumentando la sua altezza di un minimo di 7 mm (evitando inoltre eventuali accumuli di umidità). Min. 7 mm. - Max. 11 mm.

DECO & ACCESORIES

VINYLS

DECORATION

ACCESSORIES | ACCESORIOS | ACCESSOIRES | ZUBEHÖR | ACCESSORI

Y1D / Y2D Hearts vinyl | Vinilo corazones | Sticker cœurs | Aufkleber Herzen | Vinile cuori

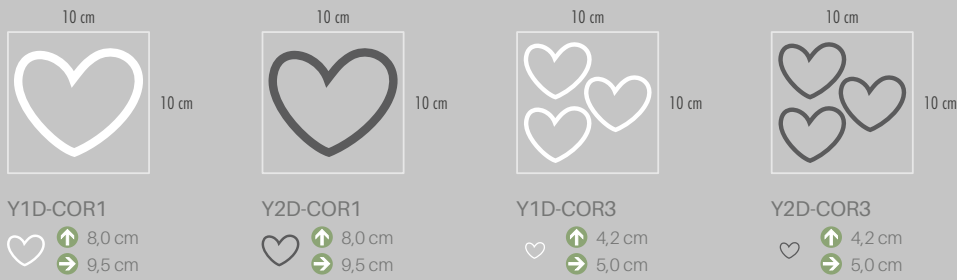

Y1D / Y2D Butterflies vinyl | Vinilo mariposas | Sticker papillons | Aufkleber Schmetterlinge | Vinile Farfalle

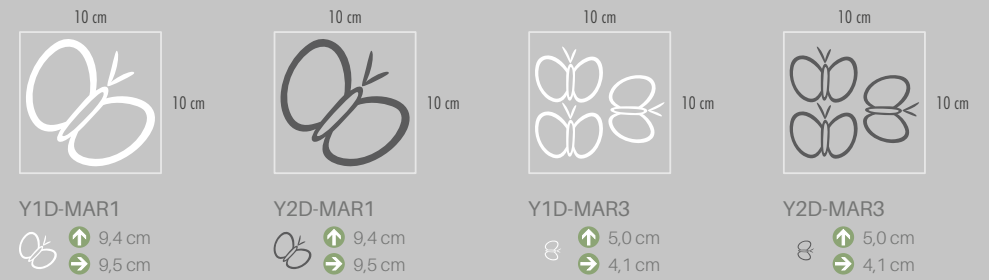

Y1D / Y2D Stars vinyl | Vinilo estrellas | Sticker étoiles | Aufkleber Sterne | Vinile stelle

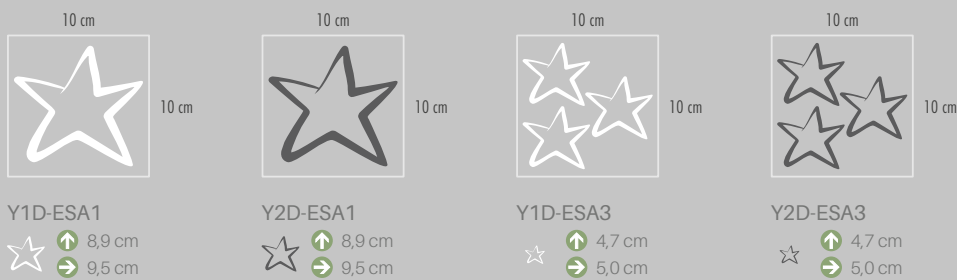

Y1D / Y2D Stars vinyl | Vinilo estrellas | Sticker étoiles | Aufkleber Sterne | Vinile stelle

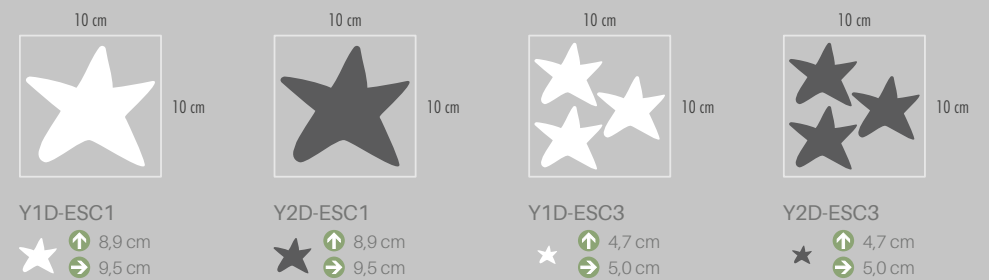

Y1D / Y2D Flowers vinyl | Vinilo flores | Sticker fleurs | Aufkleber Blumen | Vinile fiori

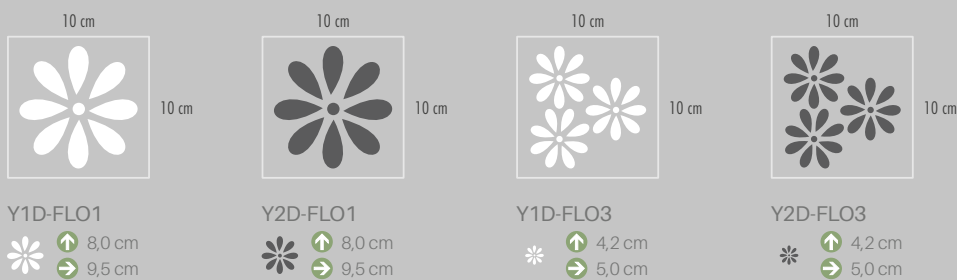

Y1S / Y2S Sun vinyl | Vinilo sol | Sticker soleil | Aufkleber Sonne | Vinile sole



Y1G / Y2G Cloud vinyl | Vinilo nube | Sticker nuage | Aufkleber Wolke | Vinile nuvola

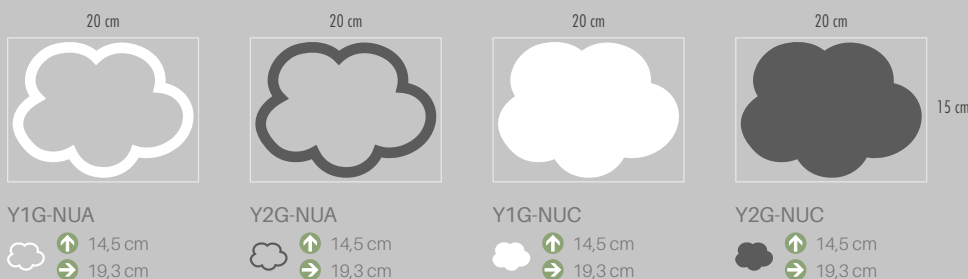

Y1G / Y2G Moon vinyl | Vinilo luna | Sticker lune | Aufkleber Mond | Vinile luna

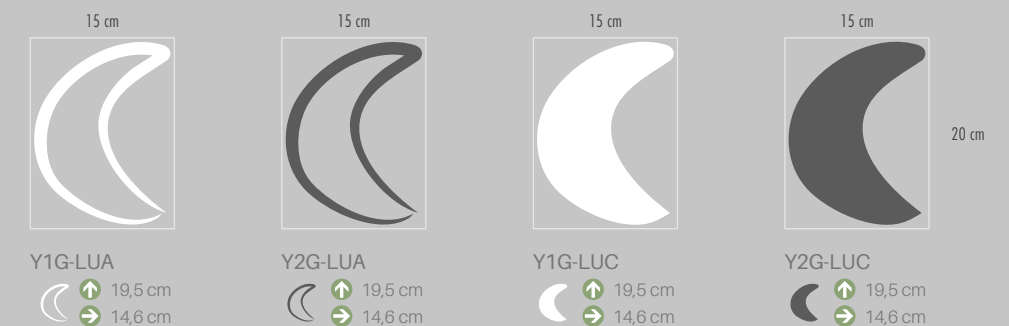

Y1 White vinyl letters | Letras vinilo blanco | Lettres autocollantes blanches Buchstaben Aufkleber weiss | Lettere vinile bianco



Y2 Gray vinyl letters | Letras vinilo gris | Lettres autocollantes grises Buchstaben Aufkleber grau | Lettere vinile grigio

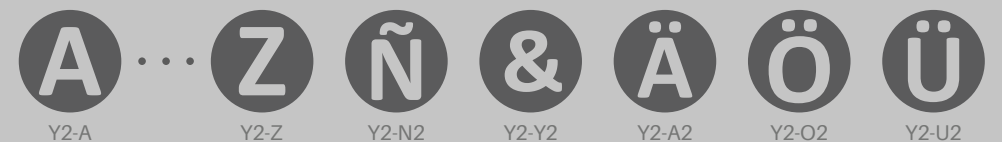

ACCESSORIES

DECORATION

ACCESSORIES | ACCESORIOS | ACCESSOIRES | ZUBEHÖR | ACCESSORI

H560 Modular shelf (small) | Balda-estante modular (pequeña)
Étagère murale modulaire (petite) | Wandregal Modular (klein) | Mensola modulare (piccola)



H560-G2300
Gloss



H560-M5100
Matte



H560-M5200
Matte



H560-M5300
Matte



H560-M7700
Matte



H560-M7800
Matte



H560-M7900
Matte



H560-M8100
Matte



H560-M8200
Matte

4 positions | 4 posiciones | 4 positions | 4 Positionen | 4 posizioni

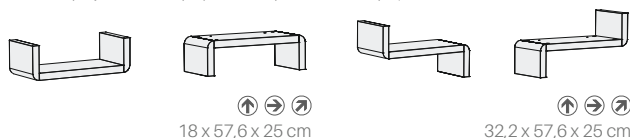

18 x 57,6 x 25 cm

32,2 x 57,6 x 25 cm

H561 Modular shelf (large) | Balda-estante modular (grande)
Étagère murale modulaire (grande) | Wandregal Modular (groß) | Mensola modulare (grande)



H561-G2300
Gloss



H561-M5100
Matte



H561-M5200
Matte



H561-M5300
Matte



H561-M7700
Matte



H561-M7800
Matte



H561-M7900
Matte



H561-M8100
Matte



H561-M8200
Matte

4 positions | 4 posiciones | 4 positions | 4 Positionen | 4 posizioni

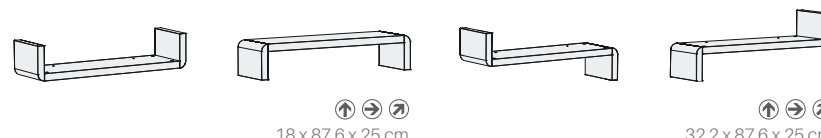

18 x 87,6 x 25 cm

32,2 x 87,6 x 25 cm

F Letters | Letras | Lettres | Buchstaben | Lettere



F-A F-B F-C F-D F-E F-F F-G



F-H F-I F-J F-K F-L F-M F-N



F-O F-P F-Q F-R F-S F-T F-U



F-V F-W F-X F-Y F-Z



REF.	Y (cm)	Z (cm)
F-A	12,8	17,6
F-B	7,7	13,6
F-C	9,6	13,6
F-D	10,8	17,6
F-E	6,6	13,6
F-F	6,2	13,6
F-G	10,8	17,6
F-H	8	13,6
F-I	3,1	13,6
F-J	7	13,6
F-K	10,6	17,6
F-L	6,9	13,6
F-M	13,5	17,6
F-N	11,3	17,6
F-O	10,2	13,6
F-P	7,2	13,6
F-Q	11,6	13,6
F-R	10	17,6
F-S	7,1	13,6
F-T	8,2	13,6
F-U	9,8	17,6
F-V	8,9	13,9
F-W	12	13,9
F-X	11,7	17,6
F-Y	8,7	13,6
F-Z	10,5	17,6

H555 Letters | Letras | Lettres | Buchstaben | Lettere



H555-G2300
Gloss



H555-M7700
Matte



H555-M7800
Matte

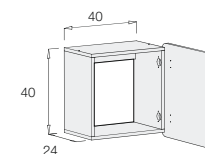

Open | Abierto
Ouvert | Geöffnet
Aperto

R-VE1 Bath changer | Vestidor bañera | Matelas à langer baignoire | Wickelauflage | Fasciatoio bagnetto

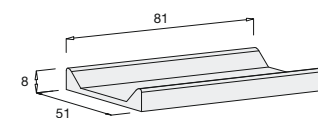

Composition: Padded vinyl | Composición: Vinilo espumado | Composition: Vinile en mousse
Zusammensetzung: Aufgeschämte Vinyl | Composizione: Schiuma di vinile

JBJ400 Bed guard | Barandilla junior | Barrière junior | Gitter Junior | Sponda junior

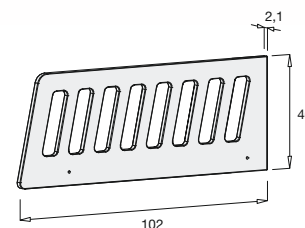

Reference Referencia Référence Referenz Riferimento	Colour Color Couleur Farbe Colore
JBJ400-G23	Gloss white Blanco brillo Blanc brillant Weiss glanz Bianco lucido
JBJ400-M77	Matte white Blanco mate Blanc mat Weiss matt Bianco opaco

Compatible with the Konver ranges

Compatible con los Konvers

Compatible avec les gammes Konver

Kompatibel mit den Konvers

Compatible con Konvers

NEO - NEO PLUS - PREMIUM KURVE

JBJ502 Bed guard | Barandilla junior | Barrière junior | Gitter Junior | Sponda junior

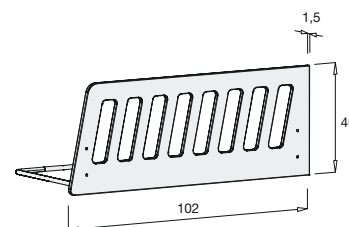

Reference Referencia Référence Referenz Riferimento	Colour Color Couleur Farbe Colore
JBJ502-G23	Gloss white Blanco brillo Blanc brillant Weiss glanz Bianco lucido
JBJ502-M77	Matte white Blanco mate Blanc mat Weiss matt Bianco opaco

Compatible with all Alondra 70x140 convertible cribs

Compatible con todos los Konvers de 70x140 de Alondra

Compatible avec tous les lits évolutifs Alondra en 70x140

Kompatibel mit allen Alondra Konvers mit den Massen 70x140

Compatible con i tutti i Konvers Alondra di 70x140

JU400 Stairs - toybox | Escalera-juguetero | Escalier - coffre à jouets | Treppe - Spielzeugkiste | Scaletta portagiochi

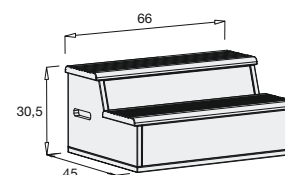

Reference Referencia Référence Referenz Riferimento	Colour Color Couleur Farbe Colore
JU400-G23	Gloss white Blanco brillo Blanc brillant Weiss glanz Bianco lucido
JU400-M77	Matte white Blanco mate Blanc mat Weiss matt Bianco opaco

Compatible with all Alondra 70x140 convertible cribs

Compatible con todos los Konvers de 70x140 de Alondra

Compatible avec tous les lits évolutifs Alondra en 70x140

Kompatibel mit allen Alondra Konvers mit den Massen 70x140

Compatible con i tutti i Konvers Alondra di 70x140

ACCESSORIES

DECORATION

J370G / J370M Additional drawers | Cajones inferiores | Tiroirs additionnels | Zusätzliche Schubladen | Cassetti inferiori



J370G-M7700

Large drawer | Cajón grande | Grand tiroir
Große Schublade | Cassetto grande

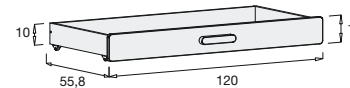

J370M-M7700

Small drawer | Cajón pequeño | Petit tiroir
Kleine Schublade | Cassetto piccolo

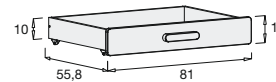

Compatible with the Konver range | Compatible con los Konvers
Compatible avec la gamme Konver | Kompatibel mit den Konvers
Compatible con Konvers

JUST

Optional drawers ref. J370G and J370M can only be used under the junior bed (not compatible with the cot during the BABY stage).

Los cajones opcionales J370G y J370M, únicamente se pueden poner bajo la cama junior. Nunca bajo la cuna en la etapa BABY.

Les tiroirs supplémentaires réf. J370G et J370M ne peuvent être utilisés qu'en dessous du lit junior (pas compatibles avec le lit évolutif pendant l'étape BABY).

Die optionalen Schubladen Ref. J370G und J370M können nur mit dem Jugendbett genutzt werden, niemals mit dem Babybett.

I cassetti aggiuntivi J370G e J370M possono essere collocati solo sotto il letto da 90x200 derivante dalla trasformazione del lettino. NON compatibile con il Konver JUST montato in fase BABY.

V656 Changer support | Soporte vestidor | Support commode à langer
Wickelaufsatz | Supporto fasciatoio cassettiere

STAGE 1 | ETAPA 1 | ÉTAPE 1
ETAPPE 1 | FASE 1



STAGE 2 | ETAPA 2 | ÉTAPE 2
ETAPPE 2 | FASE 2

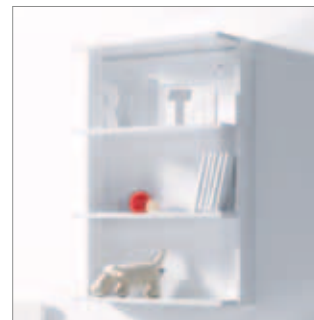

Sideways | Posición lateral
Position latérale | Seitlich
Vista laterale

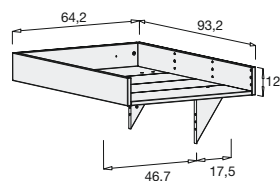

Shelf
Estantería
Étagère murale
Regal
Mensola

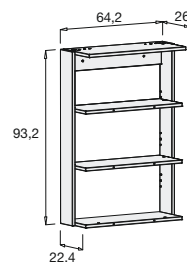

Frontal | Posición frontal
Position frontale | Frontal
Vista frontale

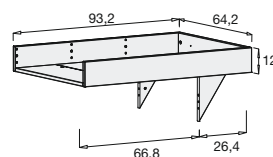

Compatible with the chest ranges | Compatible con las cómodas
Compatible avec les commodes | Kompatibel mit den Kommoden
Compatible con cassettiere

CLIP · MODULAR · PREMIUM

Reference
Referencia
Référence
Referenz
Riferimento

Colour
Color
Couleur
Farbe
Colore

V656-G2300

Gloss white
Blanco brillo
Blanc brillant
Weiss glanz
Bianco lucido

V656-M7700

Matte white
Blanco mate
Blanc mat
Weiss matt
Bianco opaco

V657 Changer support | Soporte vestidor | Support commode à langer
Wickelaufsatz | Supporto fasciatoio cassettiere

STAGE 1 | ETAPA 1 | ÉTAPE 1
ETAPPE 1 | FASE 1



STAGE 2 | ETAPA 2 | ÉTAPE 2
ETAPPE 2 | FASE 2



Sideways | Posición lateral
Position latérale | Seitlich
Vista laterale

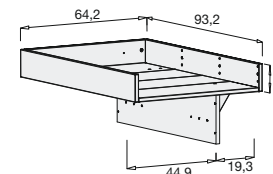

Shelf
Estantería
Étagère murale
Regal
Mensola

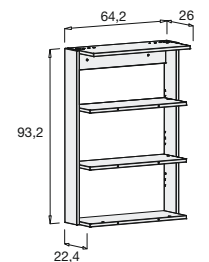

Frontal | Posición frontal
Position frontale | Frontal
Vista frontale

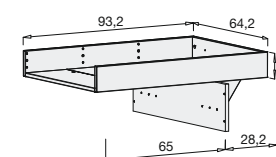

Compatible with the chest ranges | Compatible con las cómodas
Compatible avec les commodes | Kompatibel mit den Kommoden
Compatible con cassettiere

BUBBLE · EVEN · JOY

Reference
Referencia
Référence
Referenz
Riferimento

Colour
Color
Couleur
Farbe
Colore

V657-G2300

Gloss white
Blanco brillo
Blanc brillant
Weiss glanz
Bianco lucido

V657-M7700

Matte white
Blanco mate
Blanc mat
Weiss matt
Bianco opaco

DECO & ACCESSORIES

COLOURS

FURNITURE

MATTE | MATE | MATE | MATT | OPACO

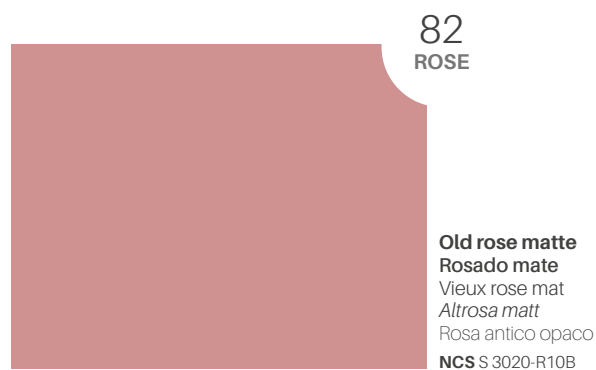
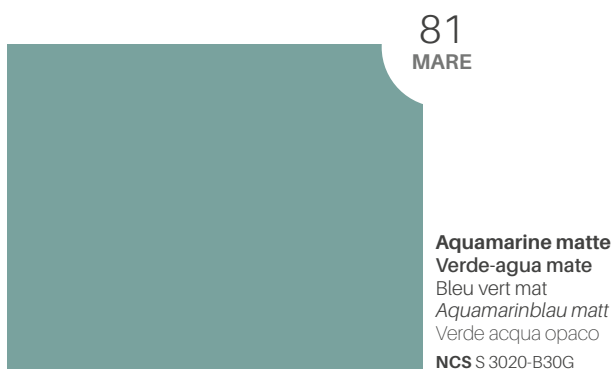
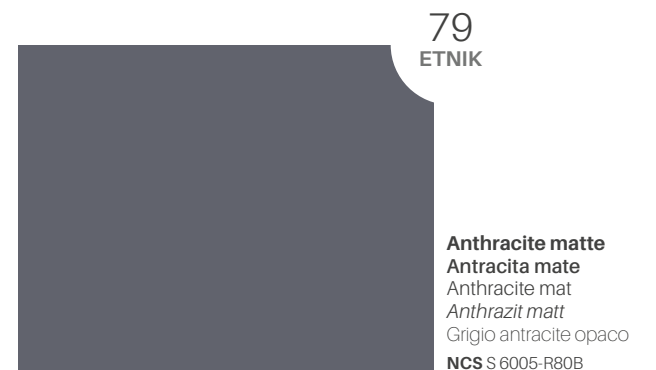
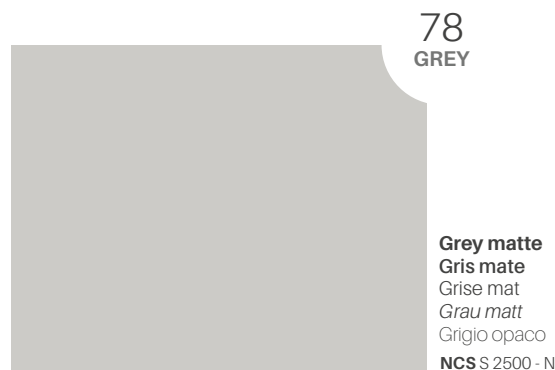
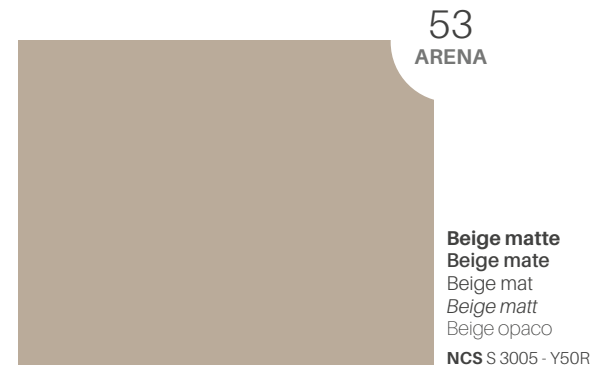
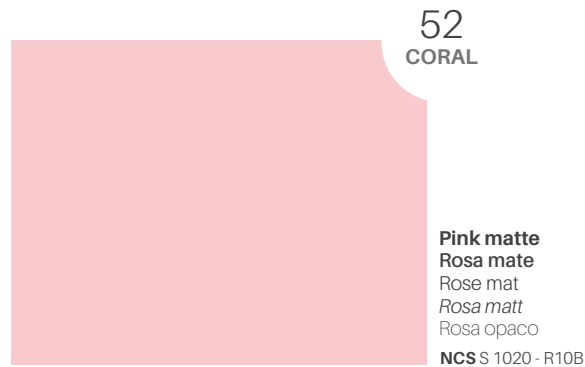
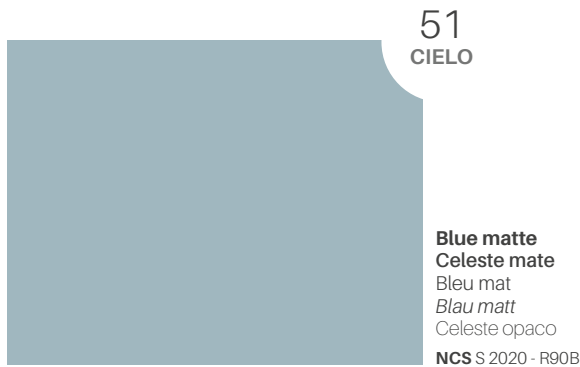

GLOSS | BRILLO | BRILLANTE | GLANZ | LUCIDO



WOOD | MADERA | BOIS | HOLZ | LEGNO

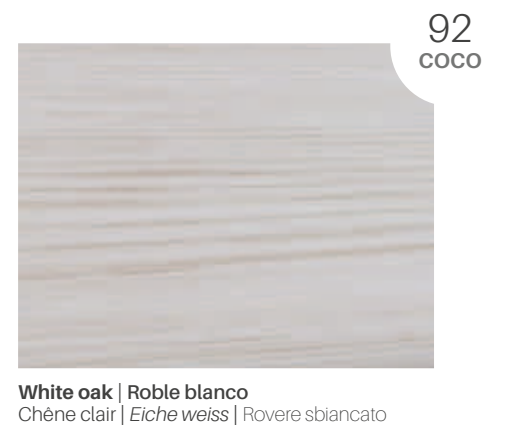
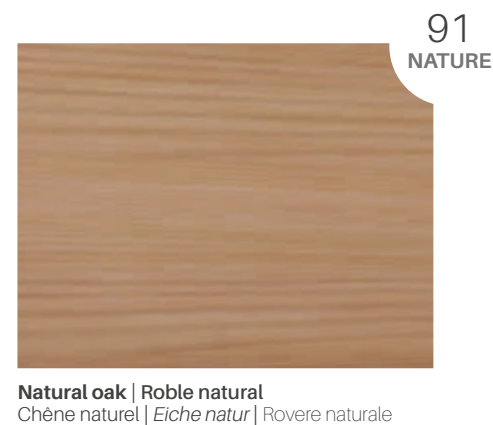



ALONDRA

www.alondrababy.com



[alondrababyrooms](#)



[alondrababy](#)



[alondra](#)



[alondrababyfurniture](#)



[alondrababyrooms](#)



[alondrababyroom](#)