

# OUTDOOR LIVING

POINT.

2022  
2023

# INDEX

<b>Introducción</b>	<b>9</b>		
<b>Sostenibilidad</b>	<b>15</b>		
<b>Diseñadores</b>	<b>19</b>	<b>CLASSIC</b>	
		Alga	204
		Charleston	212
		Sagra	218
		Caddie	222
		Havana	228
		Arena	234
		Breda	242
<b>CONTEMPORÁNEO</b>		<b>Brumas</b>	<b>246</b>
Long Island	30	<b>Bubble</b>	<b>254</b>
City	40	<b>Romantic</b>	<b>258</b>
Lis	52		
Summer	56		
Paralel	66	<b>TOPS</b>	<b>264</b>
Khai	90		
Heritage	94	<b>UMBRELLAS</b>	<b>270</b>
Weave	118	Ombra	
Arc	142	Beach	
Bay	150	Roma	
Hamp & Round	154		
Pal	162	<b>DETALLES</b>	
Fup	170	<b>TÉCNICOS</b>	<b>277</b>
Min	174		
U	184	<b>ACABADOS Y</b>	
Colors	190	<b>MANTENIMIENTO</b>	<b>353</b>
Jazz	194		
Sunset	198	<b>TELAS</b>	<b>375</b>

<b>Introduction</b>	<b>9</b>		
<b>Sustainability</b>	<b>15</b>		
<b>Designers</b>	<b>19</b>	<b>CLASSIC</b>	
		Alga	204
		Charleston	212
		Sagra	218
		Caddie	222
		Havana	228
		Arena	234
		Breda	242
<b>CONTEMPORARY</b>		<b>Brumas</b>	<b>246</b>
Long Island	30	<b>Bubble</b>	<b>254</b>
City	40	<b>Romantic</b>	<b>258</b>
Lis	52		
Summer	56		
Paralel	66	<b>TOPS</b>	<b>264</b>
Khai	90		
Heritage	94	<b>UMBRELLAS</b>	<b>270</b>
Weave	118	Ombra	
Arc	142	Beach	
Bay	150	Roma	
Hamp & Round	154		
Pal	162	<b>TECHNICAL</b>	
Fup	170	<b>DETAILS</b>	<b>277</b>
Min	174		
U	184	<b>FINISHES AND</b>	
Colors	190	<b>MAINTENANCE</b>	<b>353</b>
Jazz	194		
Sunset	198	<b>FABRICS</b>	<b>375</b>

# INTRODUC- TION



101 AÑOS  
DE ARTESANÍA  
Y DISEÑO.

Dubái, México, Australia, París, Londres, Miami... POINT es embajadora del diseño español y una referencia en mobiliario de exterior. La marca está presente en más de un millar de proyectos contract por todo el mundo –firmados por prestigiosos profesionales del interiorismo y la arquitectura– y en incontables hogares, como un aliado para sacar lo mejor de piscinas, terrazas, patios o porches. Ojeando su catálogo se encuentran cerca de 300 productos –con el sello de aplaudidos diseñadores nacionales e internacionales– donde la tradición se ha encontrado con la última tecnología.

101 YEARS  
OF CRAFTSMANSHIP  
AND DESIGN.

Dubai, Mexico, Australia, Paris, London, Miami... POINT is an ambassador of Spanish design and a leading brand of outdoor furniture. The brand is present in more than a thousand contract projects worldwide signed by prestigious interior designers and architects and in countless homes, helping to elevate swimming pools, terraces, patios and porches to another level. A browse through its catalogue reveals around 300 products created by acclaimed national and international designers, products where tradition meets the latest technology.



La historia de POINT empieza con un joven aventurero, José Pons Pedro, que abandona su tierra y aprende un oficio en Argentina para regresar, años después, a donde había dejado a padres y hermanos y montar un pequeño taller artesano de trenzado del mimbre. Hoy, cuatro generaciones después, la empresa se ha convertido en una marca internacional y una de las industrias más importantes de la Marina Alta (Alicante) y está preparada para continuar impulsando su poderoso ADN. Actualmente, encontramos sus productos en más de 1.000 proyectos de interiorismo por todo el mundo. La artesanía, la familia y la promoción del talento están en la base de esta crónica de éxito.

**The history of POINT began with a young adventurer, José Pons Pedro, who left his homeland to learn a trade in Argentina, returning years later to the place where he had left his parents and siblings and setting up a small artisan wicker weaving workshop. Now, four generations later, the company has become an international brand and one of the most important industries in the Marina Alta area (Alicante), taking its powerful DNA into the future. Today, its products can be found in more than 1000 interior design projects worldwide. This chronicle of success is based on craftsmanship, family and promoting talent.**

## POINT, Premio Nacional de Diseño 2019

Ya se han cumplido cien años desde su fundación y la apuesta por el diseño se mantiene en su ADN. En 2020, POINT recogió el Premio Nacional de Diseño 2019 del Ministerio de Ciencia, Innovación y Universidades de España por su contribución a la mejora de la sociedad y la calidad de vida de las personas.

También sigue vigente la experiencia en la fabricación de las piezas y el respeto por la artesanía –cada sofá trenzado de POINT requiere cuarenta horas de un minucioso trabajo artesanal, cada silla, no menos de seis–. La innovación, como eje del proceso creativo, ha permitido el desarrollo de nuevos materiales, incluso patentando fibras propias, e investigando en los materiales del futuro.

## Diseño, artesanía, innovación e internacionalización

POINT avanza, en el siglo XXI, sobre cuatro pilares: el diseño y la artesanía –que forman su ADN–, la internacionalización y la calidad. Tradición y modernidad les han llevado a estar presentes en más de setenta países. Pero sus raíces siguen estando en el Mediterráneo y no lo olvidan, porque sigue siendo su fuente de inspiración: en Gata de Gorgos (donde nació la compañía) y en Jalón, a unos kilómetros, donde se encuentra la sede operativa de la marca y la fabricación de las tapicerías.

“Nuestro secreto está en que hemos sido y somos fabricantes” desvelan. Con fábricas propias en Asia y un gran centro logístico en Jalón, POINT ha conseguido dinamizar la economía del entorno. A este pequeño pueblo de Alicante llegan mercancías que se distribuyen desde aquí a todo el mundo.

## POINT, 2019 Spanish National Design Award

A hundred years after it was founded, POINT’s commitment to design is still in its DNA. In 2020, POINT received the 2019 National Design Award from the Spanish Ministry of Science, Innovation and Universities for its contribution to improving society and people’s quality of life.

Its experience in furniture manufacturing and its respect for craftsmanship also continue to show through in all its pieces: each of POINT’s woven sofas involves forty hours of meticulous craftsmanship and each chair, no less than six. The innovation that is at the heart of the company’s creative process has enabled it to develop new materials, even patenting its own fibres, and to carry out research into future materials.

## Design, craftsmanship, innovation and international growth

POINT’s progress in the 21st century is based around four pillars: design and craftsmanship (which form its DNA), internationalisation and quality. Thanks to its combination of tradition and modernity, it is present in more than seventy countries. But its roots are still in the Mediterranean and they do not forget this because it continues to be their source of inspiration: in Gata de Gorgos (where the company was originally founded) and in Jalón, a few kilometres away, where the brand has its operational headquarters and manufactures its upholstery.

“Our secret is that we have always been and still continue to be manufacturers”, they reveal. With its own factories in Asia and a large logistics depot in Jalón, POINT has managed to boost the local economy. The goods are sent to this small town in Alicante, from where they are distributed all over the world.

# POINT AND SUSTAINA- BILITY



“No hay nada más sostenible que un mueble duradero que puede pasar, incluso, de generación en generación”, explican desde POINT. Hace décadas que fueron pioneros en introducir el respeto por el medio ambiente en los procesos de diseño y producción. La sostenibilidad ha sido –y es– una prioridad. Así, han desarrollado un estricto protocolo interno de diseño que exige trabajar con materiales reciclables –para que todos tengan una segunda vida útil– y que, tanto en los procesos de fabricación como en el tratamiento de residuos generados, los productos de POINT no causen impactos ambientales.

Las maderas –teca de grado A– provienen de bosques sostenibles de tala controlada. Contienen un alto nivel de aceite y gomas naturales, que le otorgan una alta flexibilidad y durabilidad. Su aceite natural se conjuga con una resina antiséptica propia que asegura que el paso del tiempo se convierta en un aliado de cada pieza.

En los muebles de POINT la selección de los tejidos no solo tiene un sentido estético, también lo tiene funcional y comprometido con el medioambiente. Todos son lavables, reversibles, duraderos y de alta calidad. Así se limita el reemplazo y los

As they say at POINT, “there’s nothing more sustainable than a hard-wearing piece of furniture that can even be passed down from generation to generation”. Decades ago, they were pioneers in introducing respect for the environment into design and production processes. Sustainability has been and still is a priority. They have therefore developed a strict in-house design protocol that requires them to work with recyclable materials so that they all have a second useful life, ensuring that POINT’s products do not have a negative impact on the environment in terms of either the manufacturing processes or treatment of the waste generated.

The wood (grade A teak) is sourced from sustainably managed forests. It contains a high level of natural oil and gums, making it highly flexible and durable. Its natural oil is combined with an antiseptic resin in the wood that enhances the beauty of each piece over time.

In POINT’s furniture, the choice of upholstery fabrics obeys not only aesthetic but also functional and environmental criteria. They are washable, reversible, hard wearing and high quality, which limits replacement and waste.



residuos. Trabajan con proveedores que les suministran materiales reciclados procedentes de fibras, hilo y tela y con empresas que convierten los sobrantes de tela en materiales nuevos. Los tejidos que emplea POINT en sus piezas cuentan con certificados que acreditan el uso de sustancias no dañinas para la salud o el entorno. POINT dispone también de certificados de calidad de sus productos, como el Certificado de Ensayo de AIDIMA (el Instituto Tecnológico del Mueble). Se reciclan al 100% el cartón, el plástico y las espumas que se utilizan en el proceso de fabricación.

Precusores en el consumo responsable y en el cuidado de la naturaleza, hace casi dos décadas transformaron su sede central de Jalón en una planta de producción de energía limpia. El sol les ha permitido ser autosuficientes energéticamente y generar más energía de la que necesitan. Con una producción fotovoltaica de 371.000 kilovatios al año, consiguen evitar la emisión a la atmósfera de 138 toneladas de dióxido de carbono (CO2), una cantidad equivalente a la que generan 50 coches de media durante un año.

They work with suppliers who provide them with recycled materials from fibres, yarn and fabric and with companies that convert leftover fabric into new materials. The fabrics that POINT uses in its pieces have certificates guaranteeing the use of substances that are safe for human health and the environment. POINT also holds quality certificates for its products, such as the AIDIMA (Furniture Technology Institute) Test Certificate. The cardboard, plastic and foams used in the manufacturing process are 100% recycled.

As some of the earliest proponents of responsible consumption and caring for nature, almost two decades ago they transformed their headquarters in Jalón into a clean energy production plant. The sun has enabled them to be energy self-sufficient and to generate more energy than they need. With a photovoltaic production of 371,000 kilowatts per year, it achieves 138 tonnes worth of carbon dioxide (CO2) emissions savings, an amount equivalent to that generated by an average of 50 cars over one year.



# DESIGNERS



## Mario Ruiz

Mario Ruiz (Alicante, 1965) es el maestro de la línea limpia y uno de los diseñadores industriales más prolíficos. Ha hecho de la sencillez y la funcionalidad su seña de identidad. En su obra hay un marcado carácter sensorial, con materiales que dibujan la luz y el aroma del Mediterráneo. Su trabajo ha sido objeto de exposiciones y monografías por todo el mundo. Ha recibido más de 50 premios en Europa y Estados Unidos. En nuestro país, en 2016, recogió el Premio Nacional de Diseño de manos del Rey Felipe VI.

Mario Ruiz (Alicante, 1965) is the master of clean lines and one of the most prolific industrial designers. He has made simplicity and functionality his hallmark. His work is distinctly sensorial, with materials suggestive of the light and flavour of the Mediterranean. His designs have been the subject of exhibitions and monographs all over the world and have received more than 50 awards in Europe and the United States. In Spain, he received the 2016 National Design Award from King Felipe VI.



## Gabriel Teixidó

En sus más de tres décadas como diseñador industrial, Gabriel Teixidó (Barcelona, 1947) se ha convertido en un acaparador de premios. Entre ellos, varios ADI-FAD y SIDI. Conocido por sus diseños austeros y alejados del exhibicionismo formal, sus piezas se convierten en grandes clásicos alejados de tendencias pasajeras.

In his more than three decades as an industrial designer, Gabriel Teixidó (Barcelona, 1947) has collected many prizes for his work, including several ADI-FAD and SIDI awards. Known for his austere designs that shy away from formal exhibitionism, his pieces are classics that do not obey passing trends.



## Vicent Martínez

Vicent Martínez (València, 1949) se ha convertido en un referente en el panorama del mueble de diseño. En su larga trayectoria acumula, entre otros, el Premio Nacional de Diseño de 1997. Sus creaciones siempre siguen la estética de la necesidad hasta en los detalles más pequeños.

Vicent Martínez (València, 1949) has become a reference point in the furniture design scene. Throughout his long career, he has won the 1997 National Design Award, among other awards. His creations always follow the aesthetics of necessity down to the smallest details.



## Christophe Pillet

Diseñador todoterreno –desde mobiliario, a producto, pasando por interiores–, arquitecto, escenógrafo, director artístico... Christophe Pillet (Montargis, Francia, 1959) es uno de los creadores más influyentes del momento. Algunas de sus piezas son parte de las colecciones del Centre Pompidou, el Centre National des Arts Plastiques, el Musée des Arts Décoratifs (en París) o el Cooper-Hewitt Museum (en Nueva York).

A versatile designer –furniture, product, interior design–, architect, stage designer, artistic director, Christophe Pillet (Montargis, France, 1959) is one of the most influential creators of our time. Some of his pieces are found in the collections of the Pompidou Centre, the *Centre National des Arts Plastiques*, the *Musée des Arts Décoratifs* (in Paris) and the Cooper-Hewitt Museum (in New York).



## Francesc Rifé

Francesc Rifé (Barcelona, 1969), tanto en su trabajo como diseñador o como interiorista, es un defensor del racionalismo y de centrar la atención en los detalles. Partidario de no emplear demasiados elementos superfluos e innecesarios en sus proyectos, hay una colección de templos gastronómicos que llevan su firma, entre los que destacan los diseñados para el chef Ricard Camarena (València). También su minimalismo cálido está presente en una gran variedad de oficinas, hoteles y tiendas.

**Francesc Rifé (Barcelona, 1969) is an advocate of rationalism and paying attention to detail, both in his work as a designer and as an interior designer. He prefers not to use too many unnecessary or superfluous elements in his projects. Various prestigious restaurants have used his designs, including the chef Ricard Camarena (Valencia). His warm minimalism is also present in a wide range of offices, hotels and shops.**



## Esther Campos

Esther Campos (Gata de Gorgos, Alicante, 1982) es diseñadora industrial. Comenzó su trayectoria en el equipo de Alfonso Gallego y, desde 2005, forma parte del departamento de diseño de POINT. Además de crear piezas y colecciones propias para la marca, supervisa los aspectos técnicos de todos los elementos que se producen, facilitando que todas las colecciones reúnan unas características de confort y funcionalidad que se adapten a los estándares de POINT.

**Esther Campos (Gata de Gorgos, Alicante, 1982) is an industrial designer. She began her career as part of Alfonso Gallego's team and, since 2005, she has been a member of POINT's design department. As well as creating her own pieces and collections for the brand, she supervises the technical aspects of all the elements that are produced, ensuring that all the collections meet POINT's standards of comfort and functionality.**





## Alfonso Gallego

Diseñador, decorador e interiorista, Alfonso Gallego (Alicante, 1964) lleva más de dos décadas colaborando con POINT. Su larga trayectoria en el desarrollo de mobiliario y sus colaboraciones en todo el mundo lo han convertido en un experto en la creación de piezas y ambientes funcionales de gran belleza y armonía.

**Designer, decorator and interior designer Alfonso Gallego (Alicante, 1964) has been working with POINT for more than two decades. His extensive experience developing furniture and his collaborations worldwide have made him an expert in creating functional pieces and ambiences of great beauty and harmony.**



## POINT Studio

POINT Studio es el equipo interno de diseño de la firma, donde se proyectan y desarrollan piezas y colecciones propias. También analizan, desde una perspectiva técnica y estética, las colecciones realizadas por los diseñadores que colaboran con la marca. Esta supervisión es imprescindible en el proceso de producción ya que permite fabricar todas las piezas con los mismos parámetros de calidad, estética y funcionalidad.

**POINT Studio is the company's in-house design team, which plans and develops its own pieces and collections. It also analyses the collections created by the designers who collaborate with the brand from a technical and aesthetic perspective. This supervision is essential in the production process as it means that all the company's products can be manufactured with the same parameters of quality, aesthetics and functionality.**



**CONTEM-  
PORARY**

# Long Island

Christophe Pillet

## Un moderno clásico

«Mi objetivo con Long Island ha sido que fuera tan deseable, con un diseño tan detallista y tan bien terminada como un mueble de interior». Explica el diseñador Christophe Pillet y añade, «busqué crear la sensación de que estas piezas siempre han existido». Formas rectas y líneas finas definen la silueta de esta colección modular de sofás de exterior. Eminentemente versátil, las piezas que la componen pueden ser un sillón, un sofá o una chaise longue adaptándose a cada espacio. Su diseño, de gran simplicidad, aspira, según confiesa Pillet, «a aportar una elegancia universal y un gran confort». Esta colección persigue convertirse en un nuevo clásico y consta de trece piezas que se complementan con tres mesas con estructura en aluminio.

## A modern classic

**“My goal with Long Island was to make it as desirable and as well finished as a piece of indoor furniture, with a similarly detailed design”, explains designer Christophe Pillet, adding “I sought to create the feeling that these pieces have always existed”. Straight shapes and slim lines define the silhouette of this modular collection of outdoor sofas. Eminently versatile, the pieces that make up the collection include an armchair, a sofa and a chaise longue, which adapt to fit each space. According to Pillet, its simple design aspires “to offer universal elegance and great comfort”. This collection seeks to become a new classic and consists of thirteen pieces that are complemented by three tables with an aluminium structure.**





















# City

Christophe Pillet

## La vida mediterránea

«Con esta colección trato de describir, de manera contemporánea, un arte de vivir mediterráneo, que no tiene que ver con el tiempo. Es un universo donde el sol y la tierra se unen». Su principal característica es una estructura de aluminio pintado en polvo, con brazos en madera de teca y unos confortables y mullidos cojines. Este conjunto crea una composición de gran comodidad y armonía. Las tres piezas de la colección –un sillón, un sofá doble y uno triple–, destilan clasicismo y elegancia y sus cojines pueden ser personalizados tanto en estampados como en colores. La colección se complementa con cuatro mesas: dos mesas de centro y dos mesas de esquina.

## Mediterranean life

**“This collection is my contemporary take on the art of Mediterranean living, which is unconnected to time. It is a universe where the sun and the earth meet”. Its main feature is a powder painted aluminium structure with teak arms and plump, comfortable cushions. These pieces create a composition of great comfort and harmony. The seats in the collection, an armchair, a double sofa and a triple sofa, exude classicism and elegance, and their cushions can be customised in terms of both prints and colours. The collection is complemented by four tables: two coffee tables and two corner tables.**























# Lis

Point Studio

## La versatilidad en pie

Un elemento que combina, sin estridencias, con diferentes colecciones, materiales y estilos. La clave de estos dos pies de mesa, desarrollados por POINT Studio, ha sido partir de un diseño, en apariencia sencillo, que encierra la filosofía de POINT. Son piezas versátiles cuyas formas simples se integran perfectamente en cualquier entorno, ayudando a conseguir ambientes contemporáneos y elegantes.

A nivel técnico, se ha trabajado en desarrollar las bases con un diámetro exacto que asegure una gran estabilidad a la mesa.

## A versatile base

**An element that can be combined with different collections, materials and styles without any fuss. The key to these two table bases, developed by POINT Studio, is that they are based on an apparently simple design that embodies POINT's philosophy. They are versatile pieces whose simple shapes integrate perfectly into any environment, helping to achieve a stylish, contemporary setting.**

**Technically, we have worked on developing the bases so that they have an exact diameter that gives the table great stability.**









# Summer

Christophe Pillet

## Tributo a la tradición

El protagonismo de la colección –compuesta por una silla y una butaca con brazos para el comedor– lo toma el trenzado de la cuerda, con el que se ha buscado rendir un homenaje a la artesanía. «Es una manera de que POINT se vuelva a conectar con sus raíces, con su tradición», declara Christophe Pillet. «Estamos ante un objeto casi indefinido, clásico, universal, que rediseñamos muy ligeramente para darle una nueva modernidad». Summer es una revisión de la silla tradicional: universal, simple, funcional y atemporal, ahora vista desde el refinamiento, la precisión técnica y la sensualidad. «El efecto decorativo se produce aquí por la textura del trenzado. Por lo tanto, hay algo muy elaborado (hecho a mano), de diseño muy fuerte y muy simple». Explica el diseñador. Está realizada en aluminio combinado con cuerda y disponible en múltiples colores.

## A tribute to tradition

The main feature of the collection, comprising a dining room chair and armchair, is the woven rope, which is intended as a homage to craftsmanship. “It is a way for POINT to reconnect with its roots, with its tradition”, says Christophe Pillet. “This is an almost indefinite, classic, universal object, which we redesigned very slightly to give it a new touch of modernity”. Summer is a new take on the traditional chair: universal, simple, functional and timeless, but now given a touch of refinement, technical precision and sensuality. “The decorative effect is produced here by the texture of the weave. It therefore has something very elaborate (handmade), with a very strong, very simple design,” explains the designer. It is made from aluminium combined with rope and is available in different colours. The collection also includes three dining tables.





















# Paralel

Gabriel Teixidó

## Serenidad atemporal

Diseñada por Gabriel Teixidó, está llamada a convertirse en un clásico. Como él mismo explica, «su elemento característico, la madera, es un material vivo que conecta bien con las personas y aporta calidez», explica su creador. Robustas y suaves a la vez, sus sillas, sillones, sofás, butacas y mesas combinan la teca de Indonesia (de bosques de tala controlada) y la cuerda sintética. Son un total de catorce piezas a las que se suman una tumbona, una mesita auxiliar y una mesa extensible. Pensadas para jardines, terrazas o porches, se integran con facilidad también en los interiores. «Es una colección humana que encaja perfectamente en ambientes naturales», señala Teixidó.

## Timeless serenity

**Designed by Gabriel Teixidó, this collection is set to become a classic. As its creator himself explains, “its characteristic element, wood, is a living element that connects well with people and gives it warmth”. Robust yet soft, its chairs, armchairs, sofas and tables combine Indonesian teak wood (from carefully managed forests) and synthetic rope. There are a total of fourteen pieces, also including a sun lounger, a side table and an extendible table. They are designed for gardens, terraces or porches, integrating easily into indoor spaces too. “It’s a human collection that fits perfectly into natural surroundings”, says Teixidó.**

















































# Khai

Point Studio

## Un viaje sensorial al Mar Egeo

El equipo de POINT Studio quiso crear una pieza con un fuerte carácter mediterráneo. Con una forma escultórica, la precisión en el trenzado de la cuerda –especialmente en la curvatura del brazo– y la perfección de su acabado artesanal, otorgan a Khai una gran personalidad. Este entramado de cuerda, disponible en tonos turrón, taupe y negro, se combina con elementos en madera de teca (procedente de bosques sostenibles de tala controlada).

## A sensory journey to the Aegean Sea

**The POINT Studio team wanted to create a piece with a strong Mediterranean flavour. With its sculptural shape, the precision of its rope weave, especially in the curve of the arm, and the perfection of its hand-crafted finish, Khai has plenty of personality. This rope weave, available in a nougat colour, taupe and black, is combined with teak wood elements (sourced from sustainably managed forests).**









# Heritage

Mario Ruiz

## Un guiño al ADN de la casa

Mario Ruiz ha partido de un profundo análisis de la historia de POINT y de sus diseños más emblemáticos para desarrollar su primera colección para la firma. En su colección Heritage, toma como referencia el famoso trenzado artesanal de la marca alicantina. También adapta materiales y formatos tradicionales a lenguajes más actuales, fluidos y soft. «Tengo una imagen de los artesanos en los años 20, en Alicante, trabajando el mimbre y creando los primeros muebles de POINT. Aquí nace su alma. Hoy, sigue siendo inspirador», señala el diseñador.

La colección rememora la elaboración y tipologías de las piezas icónicas desde dos propuestas: Heritage Lineal y Heritage Contour, dos diseños que se pueden combinar entre sí. Mientras Heritage Lineal tiene un estilo más conservador, con formas rectas y geometrías equilibradas, el diseño de Heritage Contour apuesta por una silueta más suave y orgánica para construir una figura armoniosa pero más informal. Todas las piezas están fabricadas sobre una estructura de aluminio y tejidas con cuerpo exterior de fibra técnica. Las dos líneas de la colección se expresan en múltiples versiones de sofás, butacas, sillas, taburetes, mesas auxiliares, mesas de comedor, tumbonas y daybeds.

## A nod to the company's DNA

Mario Ruiz based his first collections on an in-depth analysis of POINT's history and its most emblematic designs. In his Heritage collection, he takes the brand's famous hand weaving as a reference. He also adapts traditional materials and formats to softer, more modern and fluid languages. "I have an image of the artisans in the 1920s in Alicante working with wicker and creating POINT's first furniture. That's where its soul was born. Even today, it's still inspiring," says the designer.

The collection recreates the production and styles of these iconic pieces through two proposals: Heritage Lineal and Heritage Contour, two designs that can be combined with each other. While Heritage Lineal has a more conservative style, with straight shapes and balanced geometries, the design of Heritage Contour adopts a softer and more organic silhouette to create a harmonious but more informal piece. All the pieces are made from an aluminium frame with a woven technical fibre outer body. The two lines of the collection are expressed in multiple versions of sofas, armchairs, chairs, stools, side tables, dining tables, sun loungers and daybeds.

















































# Weave

Vicent Martínez

## La colección más premiada de POINT

Desde que nació en 2017, esta colección de líneas suaves y relajadas, no ha parado de cosechar premios internacionales como el Global Excellence Awards 2018 de la International Interior Design Association, la Medalla de Oro de la Bienal Iberoamericana CIDI de Interiorismo, Diseño y Paisajismo o el Premio ADCV ORO de Mobiliario de Exterior en 2017.

Inspirándose en el anudado de los nidos de los pájaros tejedores baya, Vicent Martínez diseñó esta colección para que fuera tan funcional como emocional. Con un acabado minucioso, cada pieza está creada a mano, anudando fibra a fibra. Consta de un total de veintisiete elementos, desde columpios a mesas, pasando por tumbonas, sofás o sillas, todas ellas con una estructura que envuelve, protege y relaja. Las últimas incorporaciones a la colección han sido un sillón comedor, un pie de mesa redondo en cuerda y una versátil jardinera que también se puede utilizar como puf o mesa. Todas las piezas tienen una estructura de aluminio pintado en polvo y el característico trenzado en cuerda. Las posibilidades para combinarlas son muy variadas gracias a sus acabados en taupe, crema y negro.

## POINT's most award-winning collection

Since it was launched in 2017, this collection with its soft, relaxed lines has reaped many international awards, such as the International Interior Design Association's 2018 Global Excellence Awards, Gold Medal in the Ibero-American Biennial CIDI for Interior, Design and Landscape and the ADCV GOLD Award for Outdoor Furniture in 2017.

Inspired by the way baya weaver birds weave their nests, Vicent Martínez designed this collection to be as functional as it is emotional. Meticulously finished, each piece is created by hand, woven strand by strand. It consists of a total of twenty seven elements, including swings, tables, sun loungers, sofas and chairs, all with a structure that envelops, protects and relaxes. The latest additions to the collection are a dining armchair, a round table base made from rope and a versatile planter that can also be used as a pouffe or table. All the pieces have a powder painted aluminium structure and the characteristic rope weave. There are a great variety of possible combinations thanks to their finishes in taupe, cream and black.

















































# Arc

Gabriel Teixidó

## Curvas seductoras

Gabriel Teixidó quiso crear una colección confortable y resistente. Tenía que ser moderna pero con un carácter neutro que le permitiese adaptarse en cualquier entorno. Apostó por emplear el trenzado tradicional en fibra reciclable Shintotex –desarrollada por POINT– para crear los asientos y respaldos, que combinó con patas en madera de teca procedente de bosques sostenibles de tala controlada y un cojín en espuma de poliuretano, preparado para soportar la intemperie. Así consiguió llegar a una colección contemporánea con detalles clásicos. Arc se compone de sillas, taburetes, sillones, mesas de centro y rincón. Las mesas auxiliares pueden ser personalizadas con diferentes materiales en las tapas, desde porcelánico, HPL y teca.

## Seductive curves

**Gabriel Teixidó wanted to create a comfortable yet hard-wearing collection. It had to be modern but with a neutral character that would allow it to fit into any environment. He chose to use a traditional weave in the recyclable Shintotex fibre, developed by POINT, to create the seats and backrests, which he combined with legs made of teak wood from sustainably managed forests and a polyurethane foam cushion that is made to withstand the elements. He has managed to achieve a contemporary collection with classic details. Arc consists of chairs, stools, armchairs, coffee tables and corner tables. The side tables can be customised with tops made from different materials, including porcelain, HPL and teak.**

















# Bay

Point Studio

## Arquitectura hecha mueble

En un primer vistazo, cautivan sus líneas rectas, la precisión de sus formas arquitectónicas. Y, después, el tacto. La madera de teca (procedente de bosques sostenibles de tala controlada), introduce un material natural que invita a tocar, a acariciar. Bay está compuesta por una tumbona y una mesita auxiliar, desarrolladas por POINT Studio. Se inspiran en el ambiente de una bahía, capturando el espíritu marinerero de un club náutico y reinterpretándolo para llevarlo a terrazas y jardines. Bay está pensada para combinarse con otras piezas y se adapta en cualquier entorno –clásico o contemporáneo–.

## Architecture as furniture

**At first glance, its straight lines and the precision of its architectural forms are captivating. As well as the feel of it. Teak wood (from sustainably managed forests) gives it a natural component that begs to be touched, caressed. Bay consists of a sun lounger and a side table developed by POINT Studio. They are inspired by the atmosphere of a bay, capturing the seafaring spirit of a yacht club and reinterpreting it for terraces and gardens. Bay is designed to be combined with other pieces and adapts to any environment, classic or contemporary.**









# Hamp & Round

Francesc Rifé

## Declaración de intenciones

Para llegar a la estética neominimalista de esta colección, Francesc Rifé trabajó en un proceso de gran complejidad técnica. La madera de teca empleada (procedente de bosques sostenibles de tala controlada) se ha torneado –como si se tratara de un tubo metálico– y se ha doblado, creando una pieza llena de expresividad. Rifé planteó un esqueleto de madera que, mediante un tejido técnico tensado, forma la base y el respaldo sobre el que se apoyan los cojines. El resultado son piezas de dimensiones generosas.

## Cerrando el círculo

La inspiración de la colección es la estética minimalista. Round está compuesta por tres mesas, realizadas en madera de teca procedente de bosques sostenibles de tala controlada. Llevan la firma de Francesc Rifé, que ha trabajado con formas sutilmente redondeadas, para llegar a una silueta estilizada y ligera que funciona con sobres de diferentes materiales o modelos.

## A statement of intentions

**Francesc Rifé developed a technically complex process to achieve the neo-minimalist look of this collection. The teak wood used (sourced from sustainably managed forests) has been turned as if it were a metal tube and bent to create a piece that is full of expressiveness. Rifé proposed a wooden skeleton with a tensioned technical fabric that forms the base and backrest on which the cushions rest. This has resulted in pieces of generous dimensions.**

## Closing the circle

**The inspiration for the collection is minimalist aesthetics. Round consists of three tables made from teak wood from sustainably managed forests. It was designed by Francesc Rifé, who has worked with subtly rounded shapes to achieve a light, stylised silhouette that works with different models of tabletop made from different materials.**













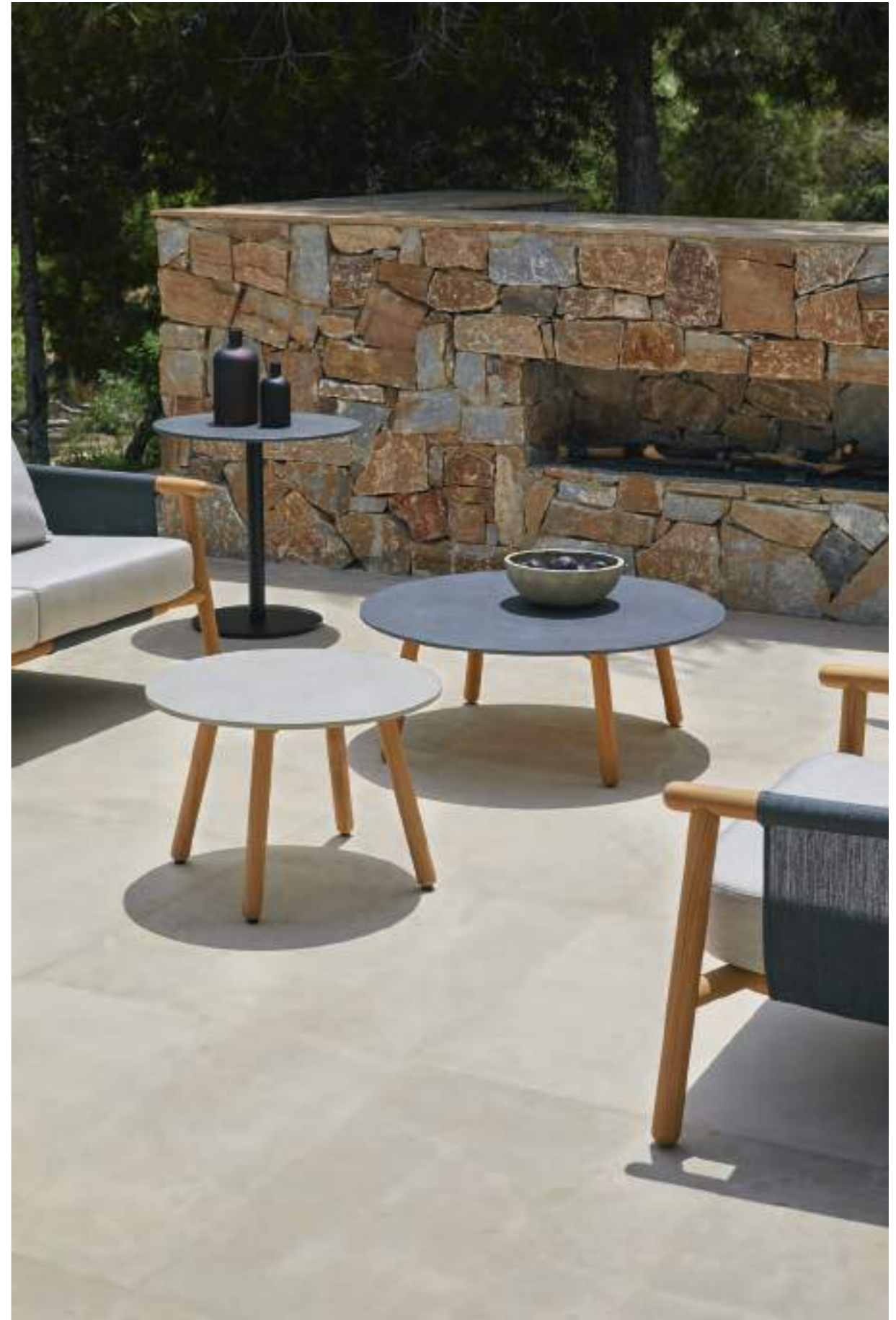



# Pal

Francesc Rifé

## Diseño que levita

«La colección nace como una pieza arquitectónica compuesta por varios módulos que le permiten un sinfín de configuraciones», explica Francesc Rifé, diseñador de la colección. Pal se construye a partir de una base de madera maciza de teca sostenible, procedente de bosques de tala controlada, que funciona como una tarima ligeramente elevada del suelo gracias a unas patas regulables e invisibles. Sobre ella se sitúan los asientos y cojines. «El efecto resultante es el de un sinuoso bloque, casi flotante», añade Rifé. El sistema modular permite componer desde tumbonas hasta sofás o asientos individuales con una amplia variedad de tejidos impermeables y colores. La serie se completa con mesas de centro de diferentes dimensiones también en teca y con una mesa lateral que parte de la base del sofá.

## A levitating design

“The collection is an architectural piece composed of several modules that allow endless configurations”, explains Francesc Rifé, the designer of the collection. Pal is made from a base of solid teak wood from sustainably managed forests that acts as a platform slightly raised off the ground thanks to adjustable, invisible legs. The seats and cushions are placed on top of it. “The resulting effect is that of a sinuous block that almost appears to be floating”, adds Rifé. The modular system makes it possible to construct anything from sun loungers to sofas or individual seats with a wide variety of waterproof fabrics and colours. The series is complemented by coffee tables of different sizes, also in teak, and a side table that arises from the base of the sofa.

















# Fup

Francesc Rifé

## Menos es más

Este conjunto de pufs de Francesc Rifé toma como eje la simplicidad de un círculo, la geometría y el equilibrio. El voluminoso cuerpo tapizado contrasta con una estrecha y resistente base de madera de teca de alta calidad, procedente de bosques sostenibles de tala controlada. Es una pieza funcional y versátil, que se integra en cualquier ambiente, en solitario o combinada con otros elementos. Está disponible en dos tamaños y en múltiples colores y tapicerías.

## Less is more

**This set of pouffes by Francesc Rifé revolves around the simplicity of a circle, geometry and balance. The bulk of the upholstered body contrasts with a strong, narrow base made from high-quality teak wood from sustainably managed forests. It is a functional and versatile piece that integrates into any setting, either on its own or combined with other elements. It is available in two sizes and in different colours and upholsteries.**









# Min

Francesc Rifé

## Mantener la línea

Liviana, casi etérea. Así se percibe esta colección cuyo diseño, de Francesc Rifé parte del cruce de unas estructuras metálicas de gran ligereza que crean ángulos en puntos estratégicos y formas geométricas simples. Se caracteriza por una base de cintas tensadas que contribuye a aportar personalidad a cada pieza y, al mismo tiempo, sirve para apoyar unos cojines de alta resistencia elaborados en espuma de poliuretano. La colección se compone de sillones, butacas y sofás. Los acabados se pueden personalizar en colores y tapicerías.

## Following the line

**Light, almost ethereal. That is the impression given by this collection whose design, by Francesc Rifé, is based on the crossing of very light metallic structures that create angles at strategic points and simple geometrical shapes. It is characterised by a base of tensioned ribbons that helps give each piece personality, while also serving to support strong cushions made from polyurethane foam. The collection is composed of armchairs and sofas. The finishes can be customised with different colours and upholsteries.**





















# U

Gabriel Teixidó

## Dando que hablar

La idea era crear una silla apilable. Sencilla, pero con un estilo propio, con un carácter único. Con esa premisa nacía una de las series con más éxito de POINT. Diseñadas por Gabriel Teixidó, las piezas de esta colección están trenzadas a mano en Shintotex –una fibra reciclable de alta resistencia desarrollada por POINT–. Está compuesta por una silla, un sillón comedor y una tumbona.

## A talking point

**The idea was to create a stackable chair. Simple, but with its own style and unique character. And so one of POINT's most successful series was based on this premise. Designed by Gabriel Teixidó, the pieces in this collection are hand-woven in Shintotex, a highly resistant recyclable fibre developed by POINT. It is composed of a chair, a dining armchair and a sun lounger.**













# Colors

Gabriel Teixidó

## Empezar con buen pie

El detalle que le aporta la personalidad, es también el que garantiza su estabilidad y resistencia: dos aspas simétricas que se unen en forma de cruz en la base. Los pies de mesa Colors están pensados para combinarse con las diferentes tapas disponibles en el catálogo de POINT. Están hechos en aluminio lacado epoxi de alta resistencia a la intemperie y se presentan en una amplia variedad de colores que va desde los tonos crema o tostados, al azul cielo, pasando por el terracota, gris, óxido o arena. Su silueta minimalista lo hace único para integrarse sin problema en cualquier ambiente.

## Start from a good base

The detail that gives it its personality is also what guarantees its stability and strength: two symmetrical blades that meet in the form of a cross at the base. Colors table bases are designed to be combined with the different tabletops available in POINT's catalogue. They are made from epoxy-lacquered aluminium, which is highly resistant to weathering and available in a wide variety of colours, ranging from cream and toasted to sky blue, terracotta, grey, rust and sand. Its minimalist silhouette makes it unique and easy to integrate into any setting.









# Jazz

Point Studio

## Un todoterreno en el jardín

Diseñada por el equipo de POINT Studio, esta tumbona reclinable está pensada para ser uno de los elementos más prácticos del exterior. «Queríamos que fuera apilable, pero también que integrase unas ruedas para facilitar su movimiento y, aunque no buscábamos que éstas fuesen un elemento protagonista, sí nos interesaba que tuvieran cierta presencia», explican desde POINT Studio. De estética minimalista, la estructura está realizada en aluminio con un tratamiento especial resistente a la corrosión. El asiento y el respaldo se han desarrollado en Batyline, un tejido sintético de alta resistencia a la intemperie y al sol que se seca rápidamente y repele los hongos y las manchas. Es un tejido flexible que se amolda al cuerpo, haciendo de Jazz una pieza muy confortable. La colección Jazz consta de una tumbona y una mesa auxiliar.

## An all-rounder in the garden

**Designed by the POINT Studio team, this reclining sun lounger is intended to be one of the most practical outdoor elements. “We wanted it to be stackable, but we also wanted it to have wheels so that it could be moved around and, although we didn’t want them to be the main element, we did want them to have a certain presence”, explain POINT Studio. With a minimalist aesthetic, the structure is made of aluminium with a special corrosion-resistant treatment. The seat and back are made from Batyline, a synthetic fabric that is highly resistant to the weather and the sun and which dries quickly and repels fungi and stains. It is a flexible fabric that moulds to the body, making Jazz a very comfortable piece. The Jazz collection consists of a sun lounger and a side table.**









# Sunset

Esther Campos

## Visto y no visto

La búsqueda de la privacidad fue la consigna que guió a Esther Campos a la hora de diseñar esta tumbona con dosel. Su estructura, en aluminio anodizado resistente a la corrosión, incorpora una base trenzada en Shintotex, una fibra reciclable de alta resistencia desarrollada por POINT. En el interior, la doble tumbona es reclinable. El exterior se envuelve con unas cortinas de Sunbrella –un tejido técnico resistente a los rayos UVA, los hongos, las manchas y a los procesos de limpieza–. «Las cortinas permiten crear momentos íntimos al aire libre, además hacen que la pieza se adapte estéticamente a cualquier ambiente», explica Campos. «Es un elemento que evoca cierto romanticismo». El techo de Sunset se produce en lona screen, un tejido con microporos que permite la entrada del aire pero mantiene el calor en el exterior.

## In an instant

The search for privacy was what guided Esther Campos when it came to designing this canopied sun lounger. Its corrosion-resistant anodised aluminium structure includes a woven base made from Shintotex, a highly resistant recyclable fibre developed by POINT. On the inside, the double sun lounger is reclining. The outside is enveloped by Sunbrella curtains, a technical fabric that is resistant to UV rays, fungus, stains and cleaning processes. “The curtains allow us to create intimate moments in the open air, as well as meaning that, aesthetically, the piece fits into any setting,” explains Campos. “It is an element that evokes a certain romanticism”. The ceiling of Sunset is formed by screen canvas, a fabric with micropores that allows air in but keeps the heat out.

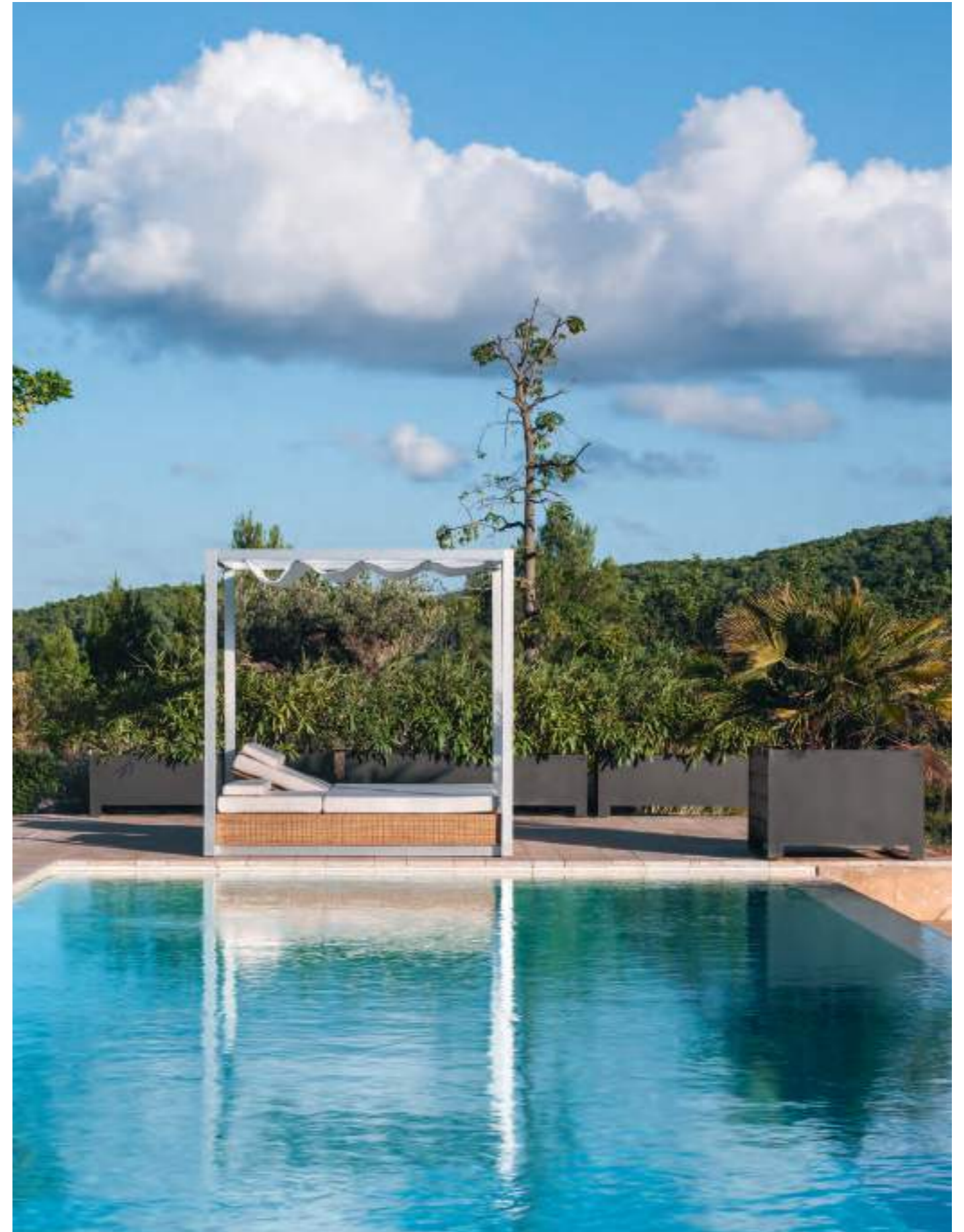







**CLASSIC**



# Alga

Alfonso Gallego

## El origen de todo

José Pons Pedro, el fundador de POINT, incorporó este modelo de sillón en las primeras colecciones (años 20). Él le aportó su toque personal de diseño y de calidad. Apostó por darle mucha rigidez en las revueltas de los brazos, de manera que no se rompieran con el paso del tiempo. También incorporó los calados del respaldo, que lo hacían menos pesado a la vista.

La dificultad de esta pieza está en que se teje toda al aire. No tiene estructura desde el asiento hacia arriba. El soporte de los brazos y de la parte superior del respaldo es el tejido que sube desde el asiento. La rigidez de las revueltas de los brazos termina por darle solidez. No la pueden elaborar todos los artesanos. Requiere manos muy expertas.

Se ha hecho en muchos materiales: mimbre, médula de ratán (en esta fibra durante más de 70 años) y posteriormente en Shintotex –una fibra reciclable de alta resistencia desarrollada por POINT– con estructura de aluminio. Esta última es la versión que continúa hoy en día en producción. La última adaptación la dirigió el diseñador Alfonso Gallego. Tenía el reto de actualizar el modelo y convertirlo en un elemento que fuera más allá del tiempo, las modas y las tendencias. Gallego define el sillón Alga como «una pieza de estilo romántico mediterráneo con identidad propia».

## The origin of it all

**José Pons Pedro, the founder of POINT, included this model of armchair in the first collections (in the 1920s). He gave it his personal touch of design and quality. He chose to make the armrests very rigid so that they would not break with the passage of time. He also included the openwork of the backrest, which made it less heavy on the eye.**

**The difficulty with this piece is that it is woven entirely in the air. It has no structure from the seat upwards. The arms and back are a continuation of the seat. The rigidity of the armrests gives it its ultimate touch of solidity. It cannot be made by just any craftsman; it requires highly expert hands.**

**It has been made with many materials: wicker, rattan core (with this fibre for more than 70 years) and later with Shintotex, a highly resistant recyclable fibre developed by POINT, with an aluminium structure, which is the version still in production today. The latest adaptation was led by designer Alfonso Gallego. He had the challenge of updating the model and turning it into an element that would go beyond time, fashions and trends. Gallego defines the Alga armchair as “a piece in the romantic Mediterranean style with its own identity”. This collection also has two round dining tables.**

















# Charleston

Alfonso Gallego

## Con swing

El glamour de los cruceros de los felices años 20 del pasado siglo inspira esta pieza diseñada por Alfonso Gallego. «El mayor reto para crear esta colección atrevida y elegante fue adaptar las estructuras y el tejido a la fibra con la que se reviste la pieza», explica el diseñador. El trenzado en Shintotex –una fibra reciclable de alta resistencia desarrollada por POINT– crea un estampado con movimiento con el que se recubre la estructura en aluminio. Charleston está disponible en color tostado.

## Swinging

This piece designed by Alfonso Gallego was inspired by the glamour of the cruise ships of the Roaring Twenties. “The biggest challenge in creating this bold, elegant collection was to adapt the structures and fabric to the fibre with which the piece is covered”, explains the designer. It is woven in Shintotex, a highly resistant recyclable fibre developed by POINT, creating a pattern with movement that covers the aluminium structure. Charleston is available in a toasted colour.













# Sagra

Alfonso Gallego

## Pieza ganadora

El sillón Sagra presume de una silueta clásica que se revisita simplificando su contorno con líneas sencillas. Un cuidado estudio de la proporción ha conseguido integrar la técnica del trenzado artesanal en ambientes contemporáneos en los que su estética convive perfectamente. Este sillón es un comodín para distintos estilos: se acopla bien al rústico chic y al estilo dolce vita, pero también es un gran jugador en los interiores.

## A winning piece

**The Sagra armchair boasts a classic silhouette that is revisited with its simple lines. A careful study of proportion has succeeded in perfectly integrating the look of its hand-woven technique into contemporary settings. This armchair is a wild card for different styles: it fits in well with a rustic chic or dolce vita style, but it is also great for interiors.**









# Caddie

Alfonso Gallego

## El mejor apoyo

El diseño se pone al servicio del espacio con el sillón Caddie firmado por Alfonso Gallego. «El punto de partida fue buscar un nuevo concepto de sillón que se convirtiera en un nuevo clásico moderno», explica. El resultado es una pieza contemporánea y equilibrada en la que se logra conjugar lo simple y lo funcional. Los sillones son apilables y están fabricados en estructura de aluminio lacada, con un trenzado en fibra Shintotex, una fibra reciclable desarrollada por POINT. Está disponible en tres acabados: tostado, marfil o negro. Todos ellos se integran fácilmente en cualquier ambiente contemporáneo.

## The best support

**Design works with space in the Caddie armchair designed by Alfonso Gallego. “The premise was to look for a new concept of armchair that would become a new modern classic”, he explains. The result is a balanced, contemporary piece that manages to combine simplicity and functionality. The armchairs are stackable and are made from a lacquered aluminium structure, woven with Shintotex fibre, a recyclable fibre developed by POINT. It is available in three finishes: toasted, ivory or black, which all integrate easily into any contemporary setting.**









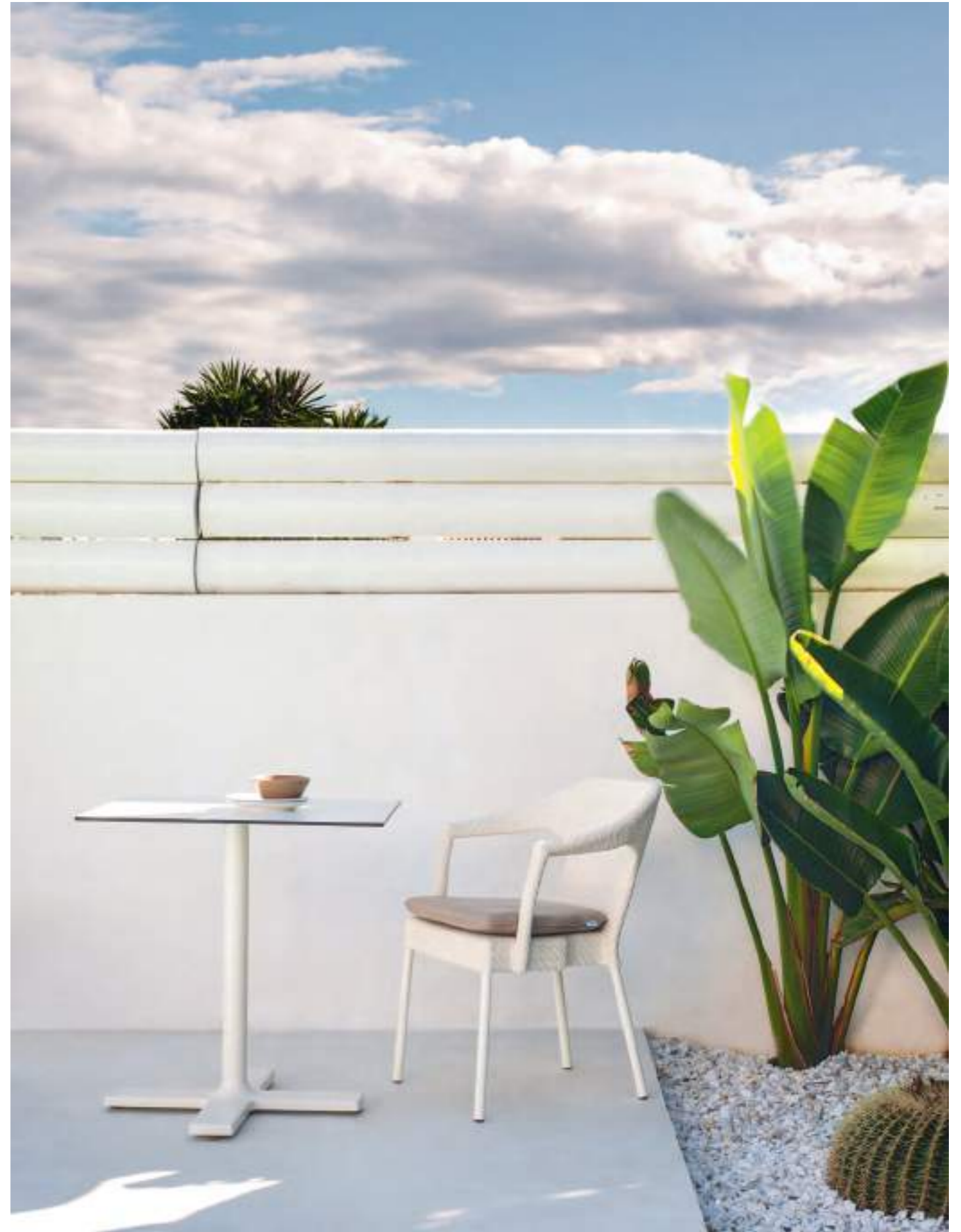
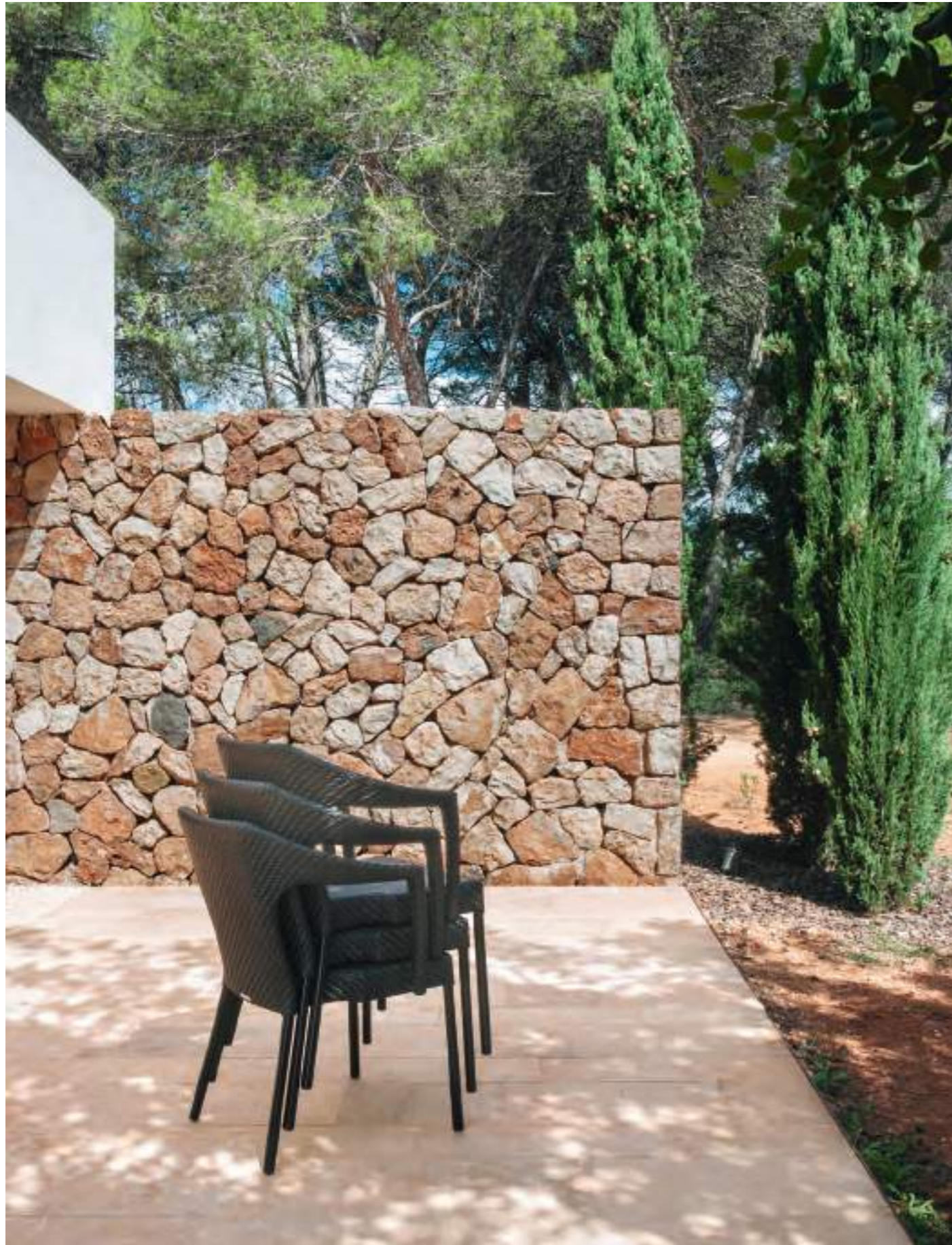



# Havana

Alfonso Gallego

## Cuestión de matices

«El Caribe, las calles de Cuba, las tardes de ron, el relax y la calidez fueron la inspiración», explica Alfonso Gallego, diseñador del sillón de comedor Havana. El contraste es la clave de esta pieza fabricada con una estructura de aluminio lacado, recubierto con un trenzado en Shintotex –una fibra reciclable de alta resistencia desarrollada por POINT-. Las formas sinuosas de esta pieza están pensadas para acoger y, como en las mejores fotos, el blanco y negro toma protagonismo en el trenzado creando dibujos llenos de ritmo.

## A matter of nuances

“The Caribbean, the streets of Cuba, afternoons drinking rum, relaxation and warmth were the inspiration”, explains Alfonso Gallego, the designer of the Havana dining armchair. Contrast is the key to this piece made from a lacquered aluminium structure covered with woven Shintotex, a highly resistant recyclable fibre developed by POINT. The sinuous shapes of this piece are designed to fold around us and, as in the best photos, black and white takes centre stage in the weave, creating patterns that are full of rhythm.













# Arena

Alfonso Gallego

## ADN mediterráneo

Esta colección se inspira en recuerdos del pasado y en los veranos mediterráneos. Alfonso Gallego parte de ellos para marcar «el inicio de una nueva etapa», según explica. Arena es una colección que busca el confort y el desenfadado, con una estética clásica que rememora las siluetas de los años sesenta. Emplea el trenzado tradicional de POINT con su fibra reciclable Shintotex sobre una estructura en aluminio y los cojines están realizados en una resistente espuma de poliuretano. La colección se compone de sillón tresillo, sofás, mesa de centro, rinconera y un puf. Está disponible en color tostado o marfil.

## Mediterranean essence

**This collection is inspired by memories of the past and Mediterranean summers. Alfonso Gallego takes them as a starting point to mark “the beginning of a new stage”, as he explains. Arena is a collection that seeks to be comfortable and casual, with a classic look reminiscent of the silhouettes of the sixties. It uses POINT’s traditional weave with its recyclable Shintotex fibre on an aluminium structure and the cushions are made from strong polyurethane foam. The collection is composed of an armchair, three-seater and two-seater sofas, coffee table, corner unit and a pouffe. It is available in a toasted colour or ivory.**

















# Breda

Alfonso Gallego

## Nuevos mitos

Compuesta por una tumbona reclinable y una mesa auxiliar, la principal característica de esta colección son sus líneas ligeramente redondeadas y un trenzado especial que crea una peculiar trama con la fibra Shintotex –una fibra reciclable desarrollada por POINT–. Para facilitar el movimiento, la tumbona incorpora ruedas. Esta colección tiene reminiscencias estéticas que evocan el diseño nórdico, pasado por un tamiz mediterráneo.

## New myths

Consisting of a reclining lounger and a side table, the main feature of this collection is its slightly rounded lines and a special weave that creates a peculiar, intertwined texture with Shintotex, a recyclable fibre developed by POINT. The lounger has wheels to make it easy to move around. The aesthetic of this collection is reminiscent of Nordic design, seen through a Mediterranean filter.









# Brumas

Alfonso Gallego

## Puro romanticismo

La inspiración nace de los muebles coloniales de exterior. Con esta base, Alfonso Gallego firma una colección que se caracteriza por su «identidad única y una gran presencia», tal como explica. Brumas reinterpreta estilos clásicos y los refresca haciéndolos más actuales y adaptables a diferentes ambientes. Las piezas se realizan a partir de una estructura de aluminio que se recubre con un trenzado tradicional artesanal en fibra Shintotex – una fibra reciclable desarrollada por POINT–, que lo hace resistente a la intemperie y duradero. La colección se compone de un sillón, sofás de dos y tres plazas.

## Pure romanticism

The inspiration comes from colonial outdoor furniture. On this basis, Alfonso Gallego has created a collection characterised by its “unique identity and great presence”, as he explains. Brumas reinterprets and updates classic styles, modernising them and making them more adaptable to different settings. The pieces are made from an aluminium structure covered with a traditional weave in Shintotex fibre, a recyclable fibre developed by POINT, which makes it weather resistant and hard wearing. The collection is composed of an lounge chair, two-seater and three-seater sofas.

















# Bubble

Alfonso Gallego

## En una burbuja

«Divertida y desenfadada», como la describe su diseñador Alfonso Gallego, la colección Bubble apuesta por las formas envolventes y acogedoras. «El reto fue definir sus volúmenes redondeados, encontrar un tejido que las acompañara y elegir una gama color de acorde», añade. Todo parte de una estructura interior en aluminio lacado que es abrazada, en su exterior, por un trenzado en fibra Shintotex –una fibra reciclable de alta resistencia desarrollada por POINT–. Completan las butacas unos cojines, en espuma de poliuretano de alta resistencia, que se pueden tapizar en telas de diferentes colores o estampados. También, como complemento, existe una mesa auxiliar. En este “nido” confluyen la estética de los setenta con un espíritu libre del mediterráneo.

## In a bubble

“Fun and carefree”, as its designer Alfonso Gallego describes it, the Bubble collection is characterised by snug, enveloping shapes. “The challenge was to define its rounded volumes, find a fabric to go with them and choose a suitable colour range”, he adds. It is all based on an inner structure of lacquered aluminium that is covered by woven Shintotex, a highly resistant recyclable fibre developed by POINT. The armchairs also have hard-wearing polyurethane foam cushions that can be upholstered in fabrics of different colours or prints. A side table is also available. This “nest” combines the aesthetics of the seventies with the free spirit of the Mediterranean.









# Romantic

Point Studio

## La reina del jardín

La suave curvatura de esta tumbona redonda ha sido pensada por el equipo de POINT Studio para ser protagonista en espacios amplios. Con o sin capota, puede ser un refugio para protegerse del sol o, simplemente, una gran tumbona sobre la que descansar. Su estructura está realizada en aluminio lacado, con un acabado especial para resistir las inclemencias del tiempo y recubierta con un trenzado en Shintotex –una fibra reciclable de alta resistencia desarrollada por POINT– y patas en aluminio anodizado.

## The queen of the garden

The soft curve of this round sun lounger has been designed by the POINT Studio team to take centre stage in large spaces. With or without a canopy, it can be a shelter from the sun or simply a large lounger on which to rest. Its structure is made from lacquered aluminium, with a special finish to resist adverse weather conditions and covered with woven Shintotex, a highly resistant recyclable fibre developed by POINT, and legs in anodised aluminium.









**TOPS**



# Tops

## Para todo, para todos

Redondas, cuadradas, familiares, auxiliares... Esta colección es sinónimo de versatilidad. Para adaptarse a cualquier espacio –exterior o interior–, Tops reúne tapas de mesa de diferentes materiales (madera de teca, HPL o porcelánico), formas y tamaños (desde 50 a 130 cm de diámetro las redondas, desde 70x70 cm las cuadradas y, de 160x90 las rectangulares). Hay versiones para todos los gustos y ambientes y todas son combinables con diferentes pies disponibles en las colecciones de POINT.

## For everything, for everyone

**Round, square, family-sized, for side tables... This collection is versatility itself. Tops offers tabletops made from different materials (teak wood, HPL and porcelain) in different shapes and sizes (50 to 130 cm diameter round ones, square ones measuring 70x70 cm and larger, and rectangular ones from 160x90 cm) to fit any space, outdoor or indoor. There are versions to suit all tastes and atmospheres and they can all be combined with the different legs available in POINT's collections.**









**UMBRELLAS**



# Ombra, Beach & Roma

Point Studio

## Tardes al sol

POINT Studio ha desarrollado una completa familia de parasoles con diferentes configuraciones que se adaptan a entornos diversos. Estructuras de aluminio con líneas depuradas, varillas de fibra de vidrio, baldosas de cerámica, hormigón o PVC con ruedas, son los materiales de los que parte cada una de las piezas. Las cubiertas están producidas en tejidos de POINT o en telas Batyline, un tejido sintético y flexible, de alta resistencia a la intemperie y al sol que se seca rápidamente y repele los hongos y las manchas.

## Afternoons in the sun

**POINT Studio has developed a complete family of different shaped sunshades to suit different settings. Each of the pieces has an aluminium structure with refined lines, fibreglass rods and ceramic, concrete or PVC tiles with wheels. The covers are made with POINT fabrics or Batyline fabrics, a flexible synthetic fabric that is highly resistant to the weather and the sun and which dries quickly and repels fungi and stains.**

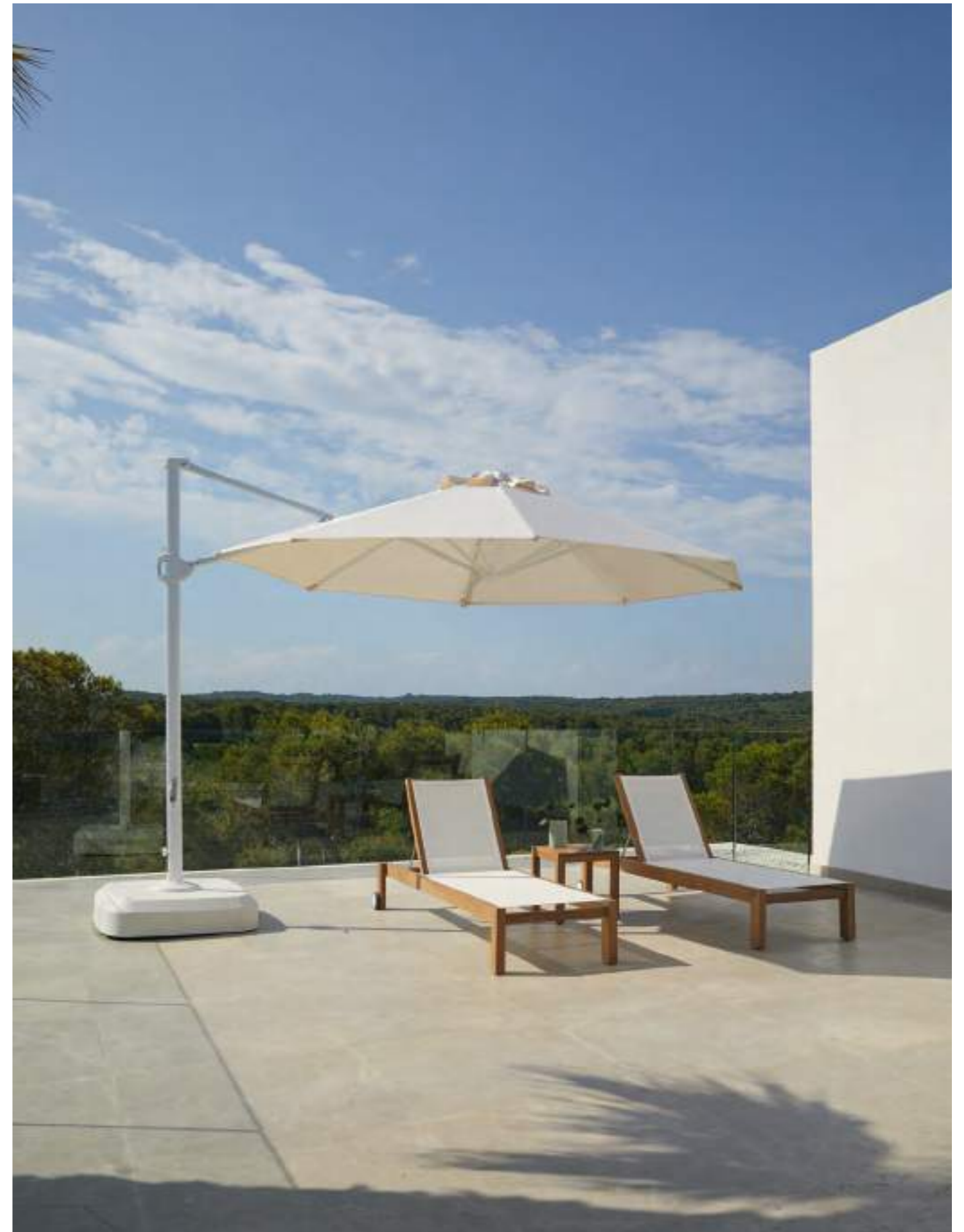











# TECHNICAL DETAILS



# Alga

## SILLÓN COMEDOR ARMCHAIR

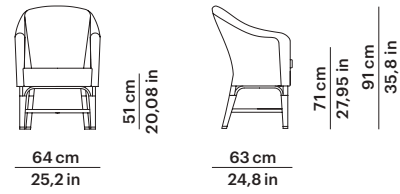

Ref. 71006

Peso Weight 9 Kg 19 lb  
m<sup>3</sup> 0,37 m<sup>3</sup>

## MESA COMEDOR REDONDA ROUND DINING TABLE

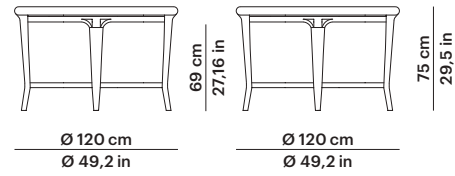

Ref. 71010

Peso Weight 13 Kg s. cristal 28 lb no glass  
28 Kg c. cristal 61 lb w. glass  
m<sup>3</sup> 1,09 m<sup>3</sup> s. cristal no glass  
1,16 m<sup>3</sup> c. cristal w. glass

## MESA COMEDOR REDONDA ROUND DINING TABLE

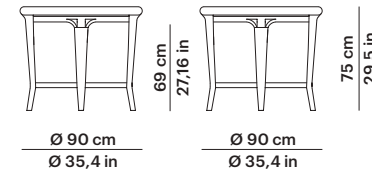

Ref. 71014

Peso Weight 10 Kg s. cristal 22 lb no glass  
23 Kg c. cristal 50 lb w. glass  
m<sup>3</sup> 0,61 m<sup>3</sup> s. cristal no glass  
0,65 m<sup>3</sup> c. cristal w. glass

# Arc

## SILLA SIDE CHAIR

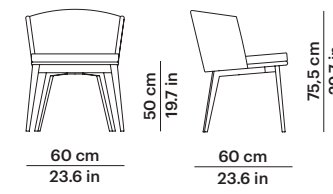

Ref. 76201

Peso Weight 10 Kg 22 lb (1pc)  
22 Kg 48.5 lb (2pcs)  
m<sup>3</sup> 0,39 m<sup>3</sup> (1pc) - 0,64 m<sup>3</sup> (2pcs)

## SILLÓN COMEDOR ARMCHAIR

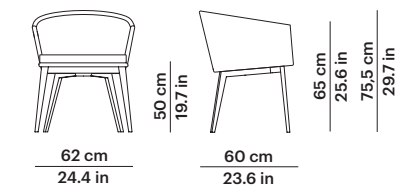

Ref. 76206

Peso Weight 10,5 Kg 23 lb (1pc)  
m<sup>3</sup> 0,42 m<sup>3</sup>

## SILLÓN CLUB CLUB LOUNGE CHAIR

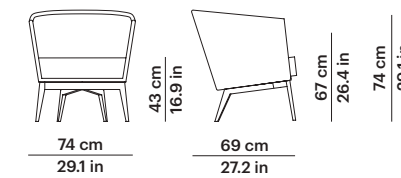

Ref. 76207

Peso Weight 13 Kg 28 lb  
m<sup>3</sup> 0,52 m<sup>3</sup>

## TABURETE BAR STOOL

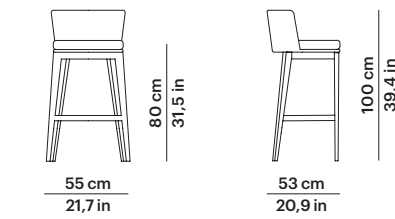

Ref. 76252

Peso Weight 9,9 Kg 21 lb  
m<sup>3</sup> 0,42 m<sup>3</sup>

### Materiales y acabados Materials and finishes

Estructura Frame  
Aluminio lacado  
Lacquered aluminum

Trenzado Weaving  
Round Ø 3 mm - Flat oval 6 mm

#### Acabados Finishes



Marfil 36  
Ivory 36



Tostado 03  
Toasted 03

### Materiales y acabados Materials and finishes

Estructura Frame  
Aluminio lacado  
Lacquered aluminum

Trenzado Weaving  
Flat oval 6 mm

Patas Legs  
Teca Natural  
Natural Teak

#### Acabados trenzado Weaving finishes



Marfil 36  
Ivory 36

#### Acabados patas Legs finishes



Teca Natural  
Natural Teak



# Arc

## SILLÓN LOUNGE CHAIR

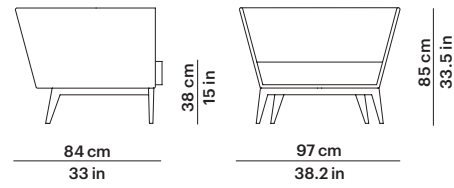

### Ref. 76245

Peso Weight	26 Kg 57 lb
m <sup>3</sup>	0,68 m <sup>3</sup>
Cuadrantes	1 (70x60 cm) (27.5x23.6 in)
Scatter cushions	1 (50x50 cm) (19.7x19.7 in)

## SOFÁ 2 SOFA 2

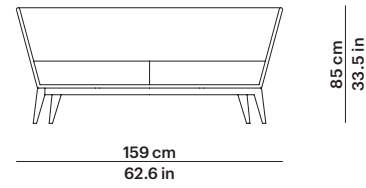

### Ref. 76247

Peso Weight	39,5 Kg 87 lb
m <sup>3</sup>	1,29 m <sup>3</sup>
Cuadrantes	2 (70x60 cm) (27.5x23.6 in)
Scatter cushions	2 (50x50 cm) (19.7x19.7 in)

## SOFÁ 3 SOFA 3

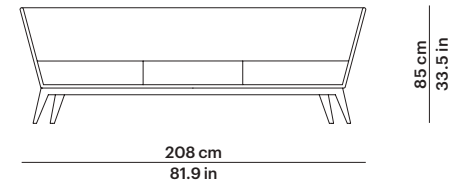

### Ref. 76249

Peso Weight	52 Kg 114 lb
m <sup>3</sup>	1,48 m <sup>3</sup>
Cuadrantes	3 (70x60 cm) (27.5x23.6 in)
Scatter cushions	3 (50x50 cm) (19.7x19.7 in)

## Materiales y acabados Materials and finishes

Estructura Frame  
Aluminio lacado Lacquered aluminum  
Trenzado Weaving  
Flat oval 6 mm  
Patas Legs  
Teca Natual Natural Teak

Acabados trenzado Weaving finishes  
Acabados patas Legs finishes



Marfil 36  
Ivory 36



Teca Natural  
Natural Teak

# Arc

## MESA RINCÓN REDONDA ROUND SIDE TABLE

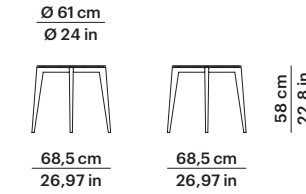

### Ref. 76256

Peso Weight	11 Kg s. cristal 24 lb no glass 14,4 Kg c. cristal 31 lb w. glass 16,87 Kg con tapa porcelánico 37,19 lb with porcelain top 12,49 Kg con tapa compacto 27,54 lb with HPL top 0,31 m <sup>3</sup> s. cristal no glass 0,4 m <sup>3</sup> c. cristal w. glass
-------------	--

## MESA CENTRO RECTANGULAR RECTANGULAR COFFEE TABLE

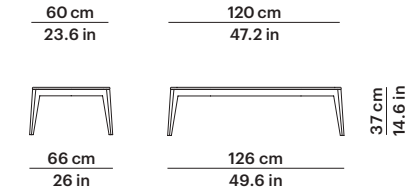

### Ref. 76254

Peso Weight	20 Kg s. cristal 59 lb no glass 26,8 Kg c. cristal 124 lb w. glass 38,82 Kg con tapa porcelánico 85.58 lb with porcelain top 24,05 Kg con tapa compacto 53.02 lb with HPL top 0,39 m <sup>3</sup> s.cristal no glass 0,45 m <sup>3</sup> c.cristal w. glass
-------------	--

## Materiales y acabados Materials and finishes

Estructura Frame  
Aluminio lacado Lacquered aluminum  
Trenzado Weaving  
Flat oval 6 mm  
Patas Legs  
Teca Natual Natural Teak

Acabados trenzado Weaving finishes



Marfil 36  
Ivory 36

Acabados patas Legs finishes



Teca Natural  
Natural Teak

Tapa Top  
Compacto HPL



Beige Beige



Negro Black

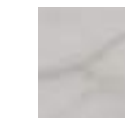

Blanco Marmolizado  
Marbled White



Madera Wood



Taupe Monocolor  
Solid Taupe

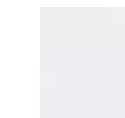

Blanco Monocolor  
Solid White

Tapa Top  
Porcelánico Porcelain



Blanco Natural 81  
Natural White 81



Gris Lava 82  
Lava Grey 82



Blanco Roto  
Veteado 85  
Veined Off White 85



Gris Basalto 86  
Basalt Grey 86

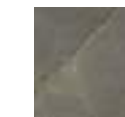

Gris Ocre 87  
Ochre Grey 87



# Arena

## SILLÓN LOUNGE CHAIR

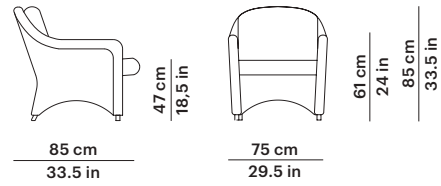

### Ref. 70045

Peso Weight 24 Kg 52 lb  
 m<sup>3</sup> 0,52 m<sup>3</sup>  
 Cuadrantes 1 (40x40 cm) (15.8x15.8 in)  
 Scatter cushions

## SOFÁ 2 SOFA 2

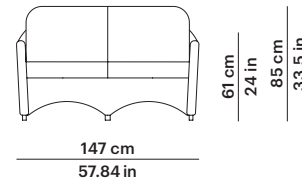

### Ref. 70047

Peso Weight 27 Kg 59 lb  
 m<sup>3</sup> 1,01 m<sup>3</sup>  
 Cuadrantes 2 (40x40 cm) (15.8x15.8 in)  
 Scatter cushions

## SOFÁ 3 SOFA 3

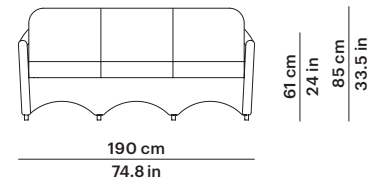

### Ref. 70049

Peso Weight 34 Kg 74 lb  
 m<sup>3</sup> 1,32 m<sup>3</sup>  
 Cuadrantes 2 (40x40 cm) (15.8x15.8 in)  
 Scatter cushions

## PUF OTTOMAN

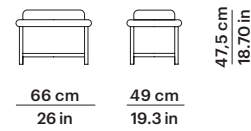

### Ref. 70052

Peso Weight 7 Kg 15 lb  
 m<sup>3</sup> 0,15 m<sup>3</sup>

## MESA CENTRO RECTANGULAR RECTANGULAR COFFEE TABLE

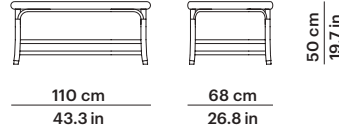

### Ref. 70053

Peso Weight 12,30 Kg s. cristal 27 lb no glass  
 21 Kg c. cristal 46 lb w. glass  
 m<sup>3</sup> 0,36 m<sup>3</sup> s. cristal no glass  
 0,39 m<sup>3</sup> c. cristal w. glass

## MESA RINCÓN CUADRADA SQUARE SIDE TABLE

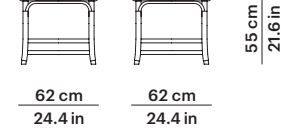

### Ref. 70056

Peso Weight 6 Kg s. cristal 13 lb no glass  
 10 Kg c. cristal 22 lb w. glass  
 m<sup>3</sup> 0,20 m<sup>3</sup> s. cristal no glass  
 0,21 m<sup>3</sup> c. cristal w. glass

### Materiales y acabados Materials and finishes

Estructura Frame  
 Aluminio lacado  
 Lacquered aluminum  
 Trenzado Weaving  
 Round Ø 3 mm - Flat oval 6 mm

#### Acabados Finishes



# Bay

## TUMBONA CHAISE

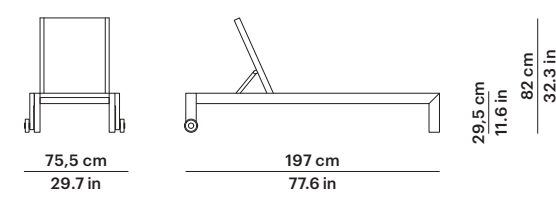

### Ref. 78495

Peso Weight 27,4 Kg 60.4 lb  
 m<sup>3</sup> 1,46 m<sup>3</sup>



## MESA AUXILIAR SIDE TABLE

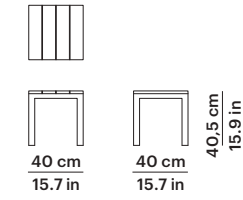

### Ref. 78458

Peso Weight 6,3 Kg 13.9 lb  
 m<sup>3</sup> 0,10 m<sup>3</sup>

### Materiales y acabados Materials and finishes

Estructura Frame  
 Teca natural  
 Natural teak  
 Telas Fabrics  
 Batyline

#### Acabados Finishes

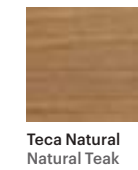

Teca Natural  
 Natural Teak

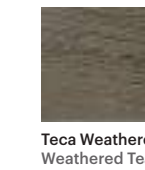

Teca Weathered  
 Weathered Teak

#### Acabados telas Fabric finishes



Batyline 35

# Breda

## TUMBONA CHAISE

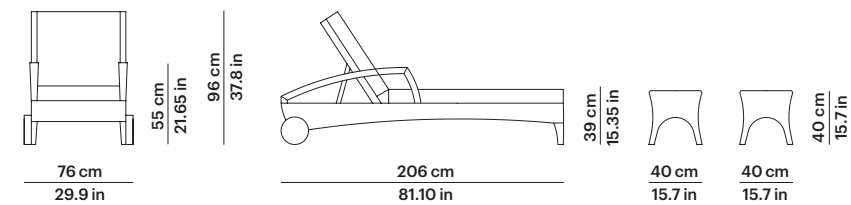

### Ref. 72095

Peso Weight 27 Kg 59 lb  
 m<sup>3</sup> 0,9 m<sup>3</sup>



## MESA AUXILIAR SIDE TABLE

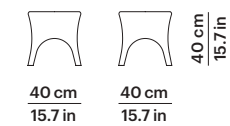

### Ref. 72058

Peso Weight 6 Kg s. cristal 13 lb no glass  
 8 Kg c. cristal 17 lb w. glass  
 m<sup>3</sup> 0,06 m<sup>3</sup> s. cristal no glass  
 0,07 m<sup>3</sup> c. cristal w. glass

### Materiales y acabados Materials and finishes

Estructura Frame  
 Aluminio pintado en polvo  
 Powder coated aluminum  
 Trenzado Weaving  
 Flat oval 6 mm

#### Acabados Finishes

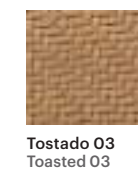

Tostado 03  
 Toasted 03



# Brumas

## SILLÓN LOUNGE CHAIR

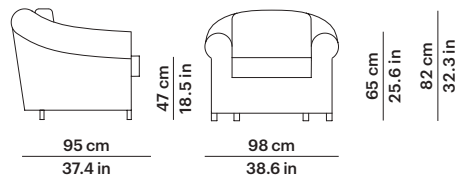

### Ref. 71145

Peso Weight 20 Kg 44 lb  
 m<sup>3</sup> 0,68 m<sup>3</sup>  
 Cuadrantes 1 (40x40 cm) (15.8x15.8 in)  
 Scatter cushions

## SOFÁ 2 SOFA 2

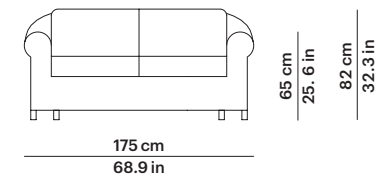

### Ref. 71147

Peso Weight 34 Kg 74 lb  
 m<sup>3</sup> 1,30 m<sup>3</sup>  
 Cuadrantes 2 (40x40 cm) (15.8x15.8 in)  
 Scatter cushions

## SOFÁ 3 SOFA 3

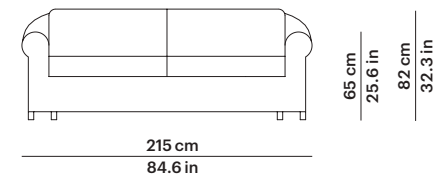

### Ref. 71149

Peso Weight 43 Kg 94 lb  
 m<sup>3</sup> 1,59 m<sup>3</sup>  
 Cuadrantes 3 (40x40 cm) (15.8x15.8 in)  
 Scatter cushions

### Materiales y acabados Materials and finishes

Estructura Frame  
 Aluminio lacado  
 Lacquered aluminum  
 Trenzado Weaving  
 Round Ø 3 mm

### Acabados Finishes



Tostado 03  
Toasted 03

# Bubble

## SILLÓN LOUNGE CHAIR

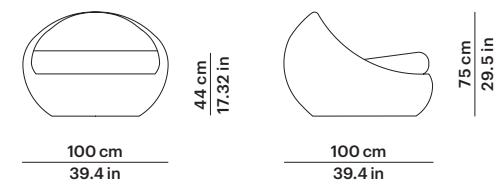

### Ref. 72445

Peso Weight 20 Kg 44 lb  
 m<sup>3</sup> 0,68 m<sup>3</sup>  
 Cuadrantes 1 (40x40 cm) (15.8x15.8 in)  
 Scatter cushions 1 (50x50 cm) (19.7x19.7 in)

## MESA RINCÓN REDONDA ROUND SIDE TABLE

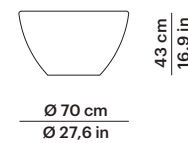

### Ref. 72456

Peso Weight 6,5 Kg s. cristal 14 lb no glass  
 9 Kg c. cristal 19 lb w. glass  
 m<sup>3</sup> 0,25 m<sup>3</sup>s. cristal no glass  
 0,26 m<sup>3</sup>c. cristal w. glass

### Materiales y acabados Materials and finishes

Estructura Frame  
 Aluminio pintado en polvo  
 Powder coated aluminum  
 Trenzado Weaving  
 Round Ø 3 mm

### Acabados Finishes



Marfil 36  
Ivory 36



Tostado 03  
Toasted 03

# Caddie

## SILLÓN COMEDOR ARMCHAIR

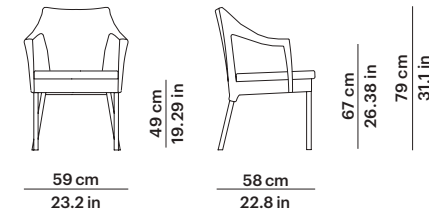

### Ref. 71207

Peso Weight 8 Kg (1pc) 17 lb (1pc)  
 23 Kg (4pc) 50 lb (4pc)  
 m<sup>3</sup> 0,31 m<sup>3</sup>(1pc) - 0,5 m<sup>3</sup>(4pc)

### Materiales Materials

Estructura Frame  
 Aluminio lacado  
 Lacquered aluminum  
 Trenzado Weaving  
 Flat oval 6 mm

### Acabados Finishes



Marfil 36  
Ivory 36



Tostado 03  
Toasted 03



Dark 59  
Dark 59

# Charleston

## SILLÓN COMEDOR ARMCHAIR

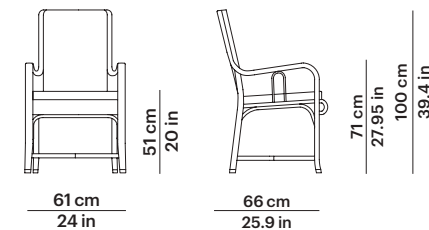

### Ref. 73306

Peso Weight 8,5 Kg 18 lb  
 m<sup>3</sup> 0,4 m<sup>3</sup>

### Materiales y acabados Materials and finishes

Estructura Frame  
 Aluminio lacado  
 Lacquered aluminum  
 Trenzado Weaving  
 Flat oval 6 mm

### Acabados Finishes



Tostado 03  
Toasted 03



# City

## SILLÓN LOUNGE CHAIR

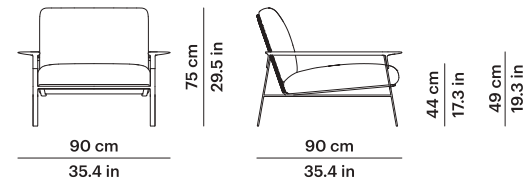

### Ref. 78345

Peso Weight **26,6 Kg 58.6 lb**  
 m<sup>3</sup> **0,85 m<sup>3</sup>**  
 Cuadrantes **1 (60x35 cm) (23.6x13.7 in)**  
 Scatter cushions

## SOFÁ 2 SOFA 2

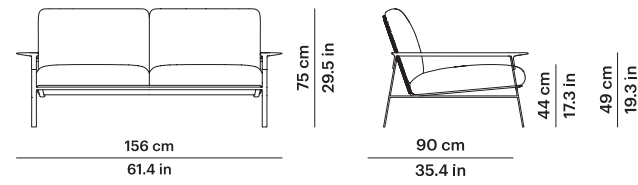

### Ref. 78347

Peso Weight **45,5 Kg 100 lb**  
 m<sup>3</sup> **1,41 m<sup>3</sup>**  
 Cuadrantes **2 (60x35 cm) (23.6x13.7 in)**  
 Scatter cushions

## SOFÁ 3 SOFA 3

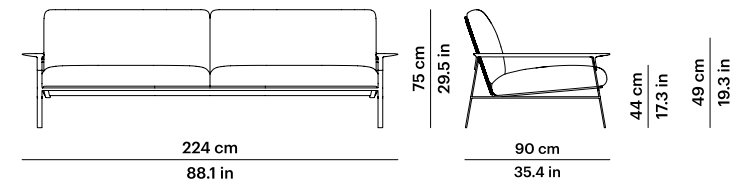

### Ref. 78349

Peso Weight **57,8 Kg 127.4 lb**  
 m<sup>3</sup> **2 m<sup>3</sup>**  
 Cuadrantes **2 (60x35 cm) (23.6x13.7 in)**  
 Scatter cushions **2 (40x40 cm) (15.8x15.8 in)**

## Materiales y acabados Materials and finishes

<b>Estructura</b> Frame	<b>Aluminio pintado en polvo</b> Powder coated aluminium Cuerda Ø4 mm Rope Ø4 mm		
			
<b>Teca Natural</b> Natural Teak	<b>Crema 34</b> Cream 34 <b>Beige</b> Beige	<b>Arena 74</b> Sand 74 <b>Gris Perlado</b> Pearl Grey	<b>Gris Metalizado 56</b> Gunmetal Grey 56 <b>Grafito</b> Graphite

# City

## MESA CENTRO CUADRADA SQUARE COFFEE TABLE

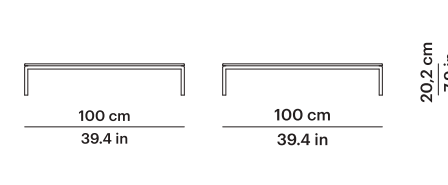

### Ref. 78353

Peso Weight **39,2 Kg con tapa porcelánico**  
 86.4 lb with porcelain top  
**28,2 Kg con tapa compacto**  
 62.2 lb with HPL top  
 m<sup>3</sup> **0,42 m<sup>3</sup>**

## MESA CENTRO RECTANGULAR RECTANGULAR COFFEE TABLE

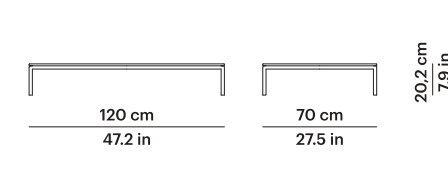

### Ref. 78354

Peso Weight **37,1 Kg con tapa porcelánico**  
 81.8 lb with porcelain top  
**28,7 Kg con tapa compacto**  
 61.3 lb with HPL top  
 m<sup>3</sup> **0,36 m<sup>3</sup>**

## MESA RINCÓN CUADRADA SQUARE SIDE TABLE

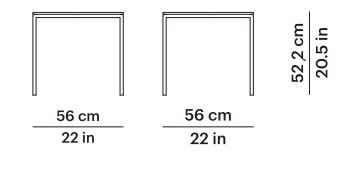

### Ref. 78356

Peso Weight **16,7 Kg con tapa porcelánico**  
 36.8 lb with porcelain top  
**13,3 Kg con tapa compacto**  
 29.3 lb with HPL top  
 m<sup>3</sup> **0,28 m<sup>3</sup>**



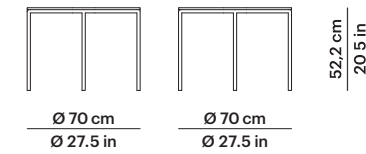





## MESA RINCÓN REDONDA ROUND SIDE TABLE

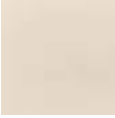
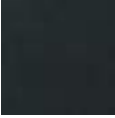

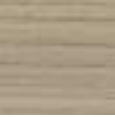
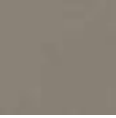
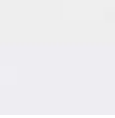
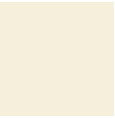
### Ref. 78357

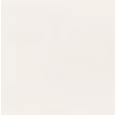
Peso Weight **20,8 Kg con tapa porcelánico**  
 45.8 lb with porcelain top  
**15,4 Kg con tapa compacto**  
 34 lb with HPL top  
 m<sup>3</sup> **0,41 m<sup>3</sup>**

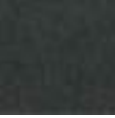
## Materiales y acabados Materials and finishes

<b>Estructura</b> Frame	<b>Tapa Top Compacto HPL</b>					
<b>Aluminio pintado en polvo</b> Powder coated aluminium						
	<b>Beige Beige</b>	<b>Negro Black</b>	<b>Blanco Marmolizado</b> Marbled White	<b>Madera Wood</b>	<b>Taupe Monocolor</b> Solid Taupe	<b>Blanco Monocolor</b> Solid White
<b>Crema 34</b> Cream 34	<b>Tapa Top Porcelánico Porcelain</b>					
						
<b>Arena 74</b> Sand 74	<b>Gris Metalizado 56</b> Gunmetal Grey 56	<b>Blanco Natural 81</b> Natural White 81	<b>Gris Lava 82</b> Lava Grey 82	<b>Blanco Roto Veteado 85</b> Veined Off White 85	<b>Gris Basalto 86</b> Basalt Grey 86	<b>Gris Ocre 87</b> Ochre Grey 87



# Colors

## PIE DE MESA TABLE BASE

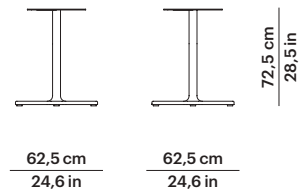

### Ref. 74214

Peso Weight 13,5 Kg 29 lb  
 m<sup>3</sup> 0,37 m<sup>3</sup>  
 Medida tapa Ø 70 - Ø 80 - Ø 90 cm  
 Top size 70x70 - 80x80 - 90x90 cm  
 Ø 27.6 - Ø 31.5 - Ø 35.4 In  
 27.6x27.6 - 31.5x31.5 - 35.4x35.4 In

## PIE DE MESA DOBLE DOUBLE TABLE BASE

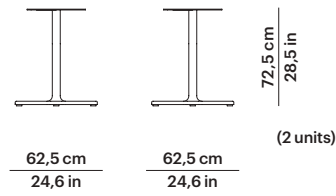

### Ref. 74208

Peso Weight 13,5 Kg 29 lb  
 m<sup>3</sup> 0,37 m<sup>3</sup>  
 Medida tapa 160x90 cm  
 Top size 63x35.4 In

# Fup

## PUF OTTOMAN

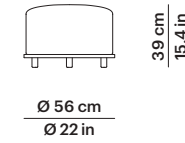

### Ref. 77751

Peso Weight 8,4 Kg 18.5 lb  
 m<sup>3</sup> 0,18 m<sup>3</sup>

## PUF OTTOMAN

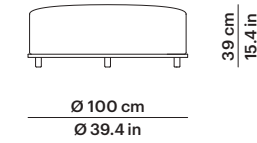

### Ref. 77752

Peso Weight 25,8 Kg 56.9 lb  
 m<sup>3</sup> 0,46 m<sup>3</sup>

## Materiales y acabados Materials and finishes

Estructura Frame  
 Aluminio pintado en polvo  
 Powder coated aluminum

### Acabados Finishes



Blanco Nieve 70  
 White Snow 70



Crema 34  
 Cream 34



Tostado 03  
 Toasted 03



Arena 74  
 Sand 74



Óxido 75  
 Oxide 75



Taupe 60  
 Taupe 60



Gris Metalizado 56  
 Gunmetal Grey 56



Negro 59  
 Black 59



Terracota 72  
 Terracotta 72



Verde Ficus 73  
 Green Ficus 73



Azul Cielo 71  
 Blue Sky 71

## Materiales y acabados Materials and finishes

Estructura Frame



Teca Natural  
 Natural Teak



# Hamp

## SILLÓN COMEDOR ARMCHAIR

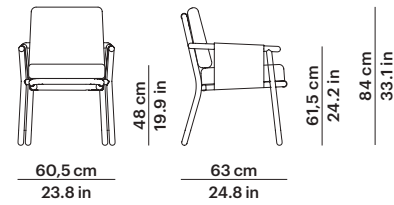

Ref. 76706

Peso Weight  
m<sup>3</sup> 10 Kg 22 lb  
0,4 m<sup>3</sup>

## SILLÓN LOUNGE CHAIR

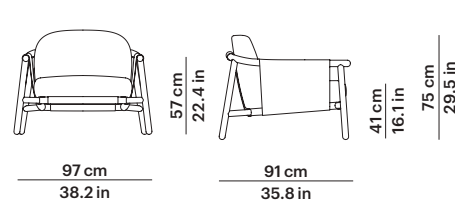

Ref. 76745

Peso Weight  
m<sup>3</sup> 21 Kg 46 lb  
0,86 m<sup>3</sup>  
Cuadrantes  
Scatter cushions  
1 (50x50 cm) (19.7x19.7 in)

## SOFÁ 2 SOFA 2

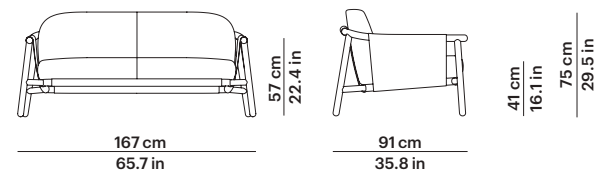

Ref. 76747

Peso Weight  
m<sup>3</sup> 32 Kg 70 lb  
1,44 m<sup>3</sup>  
Cuadrantes Scatter cushions  
2 (50x50 cm) (19.7x19.7 in)

### Materiales y acabados Materials and finishes

#### Estructura Frame

Teca natural  
Natural teak  
Telas Fabrics  
Batyline

#### Acabados telas Fabric finishes



Batyline 13



Batyline 09



Batyline 10



Batyline 11

#### Acabado estructura Frame finishes



Teca Natural  
Natural Teak

# Havana

## SILLÓN COMEDOR ARMCHAIR

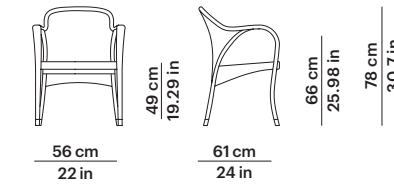

Ref. 73307

Peso Weight  
m<sup>3</sup> 5,5 Kg 12 lb  
0,27 m<sup>3</sup>

### Materiales y acabados Materials and finishes

#### Estructura Frame

Aluminio Lacquered aluminum  
Trenzado Weaving  
Round Ø 2 mm - Flat oval 6 mm

#### Acabados trenzado Weaving finishes



Marfil 36  
Ivory 36

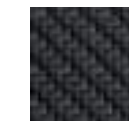

Dark 59  
Dark 59

# Heritage

## SILLA SIDE CHAIR

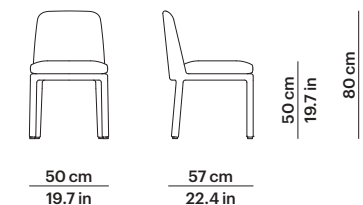

Ref. 78601

Peso Weight  
m<sup>3</sup> 8,7 Kg 19.2 lb  
0,30 m<sup>3</sup>

## SILLÓN COMEDOR ARMCHAIR

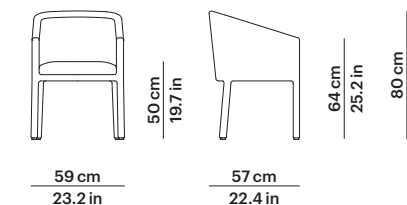

Ref. 78606

Peso Weight  
m<sup>3</sup> 11,3 Kg 24,9 lb  
0,35 m<sup>3</sup>

## SILLÓN COMEDOR ARMCHAIR

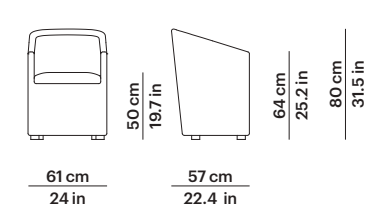

Ref. 78506

Peso Weight  
m<sup>3</sup> 14,9 Kg 32.8 lb  
0,36 m<sup>3</sup>

### Materiales y acabados Materials and finishes

#### Estructura Frame

Aluminio Lacquered aluminum  
Trenzado Weaving  
Round Ø 6 mm

#### Acabados trenzado Weaving finishes

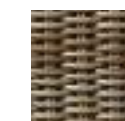

Moss Brown



Ash Grey



# Heritage

## SILLÓN LOUNGE CHAIR

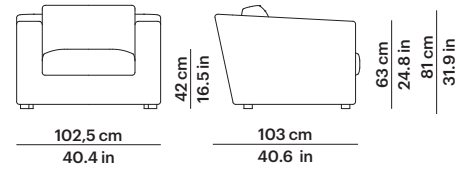

Ref. 78545

Peso Weight 33,7 Kg 74.3 lb  
 m<sup>3</sup> 1,03 m<sup>3</sup>  
 Cuadrantes Scatter cushions 1 (40x40 cm) (15.8x15.8 in)

## SOFÁ 2 SOFA 2

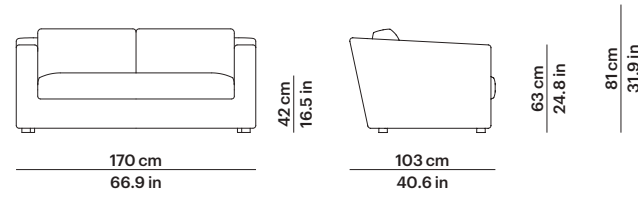

Ref. 78547

Peso Weight 48,6 Kg 107.1 lb  
 m<sup>3</sup> 1,67 m<sup>3</sup>  
 Cuadrantes Scatter cushions 2 (40x40 cm) (15.8x15.8 in)

## SOFÁ 2 MODULAR BRAZO DERECHO RIGTH ARM SECTIONAL SOFA 2

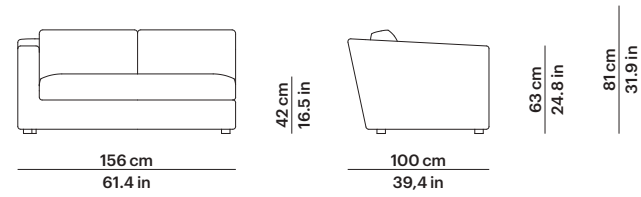

Ref. 78544

Peso Weight 49,6 Kg 109,3 lb  
 m<sup>3</sup> 1,48 m<sup>3</sup>  
 Cuadrantes Scatter cushions 1 (40x40 cm) (15.8x15.8 in)

## SOFÁ 2 MODULAR BRAZO IZQUIERDO LEFT ARM SECTIONAL SOFA 2

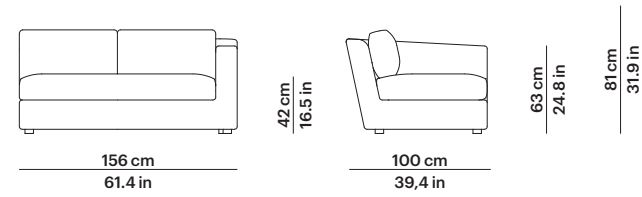

Ref. 78546

Peso Weight 49,6 Kg 109,3 lb  
 m<sup>3</sup> 1,48 m<sup>3</sup>  
 Cuadrantes Scatter cushions 1 (40x40 cm) (15.8x15.8 in)

## RINCONERA CORNER

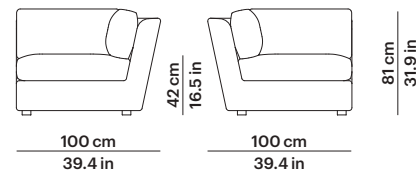

Ref. 78551

Peso Weight 33,7 Kg 74.3 lb  
 m<sup>3</sup> 0,98 m<sup>3</sup>

### Materiales y acabados Materials and finishes

Estructura Frame  
 Aluminio Lacquered aluminum  
 Trenzado Weaving  
 Round Ø 6 mm

Acabados trenzado Weaving finishes

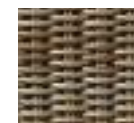

Moss Brown



Ash Grey

# Heritage

## SOFÁ 3 SOFA 3

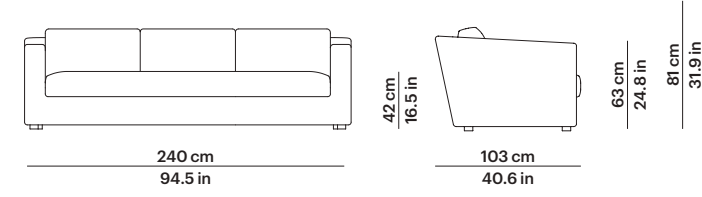

Ref. 78549

Peso Weight 72,8 Kg 160.5 lb  
 m<sup>3</sup> 2,33 m<sup>3</sup>  
 Cuadrantes Scatter cushions 2 (40x40 cm) (15.8x15.8 in)

## SOFÁ 3 MODULAR BRAZO DERECHO RIGTH ARM SECTIONAL SOFA 3

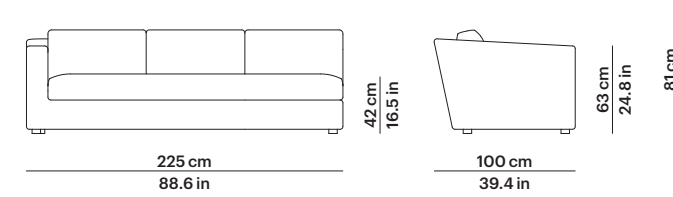

Ref. 78542

Peso Weight 64.4 Kg 142 lb  
 m<sup>3</sup> 2,13 m<sup>3</sup>  
 Cuadrantes Scatter cushions 1 (40x40 cm) (15.8x15.8 in)

## SOFÁ 3 MODULAR BRAZO IZQUIERDO LEFT ARM SECTIONAL SOFA 3

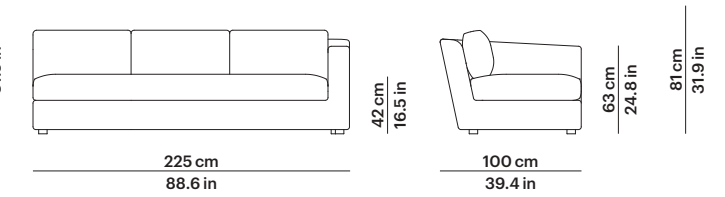

Ref. 78543

Peso Weight 64.4 Kg 142 lb  
 m<sup>3</sup> 2,13 m<sup>3</sup>  
 Cuadrantes Scatter cushions 1 (40x40 cm) (15.8x15.8 in)

### Materiales y acabados Materials and finishes

Estructura Frame  
 Aluminio Lacquered aluminum  
 Trenzado Weaving  
 Round Ø 6 mm

Acabados trenzado Weaving finishes

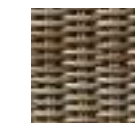

Moss Brown



Ash Grey



# Heritage

## SILLÓN CLUB CURVO CURVED CLUB LOUNGE CHAIR

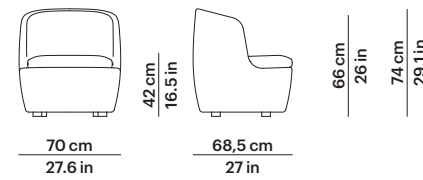

Ref. 78705

Peso Weight 19,5 Kg 43 lb  
m<sup>3</sup> 0,45 m<sup>3</sup>

## SILLÓN CURVO CURVED LOUNGE CHAIR

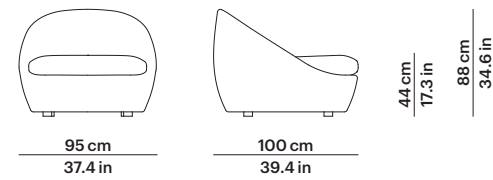

Ref. 78745

Peso Weight 28,3 Kg 62.4 lb  
m<sup>3</sup> 1,01 m<sup>3</sup>  
Cuadrantes Scatter cushions 1 (50x50 cm) (19.7x19.7 in)  
1 (40x40 cm) (15.8x15.8 in)

## SOFÁ 2 CURVO CURVED SOFA 2

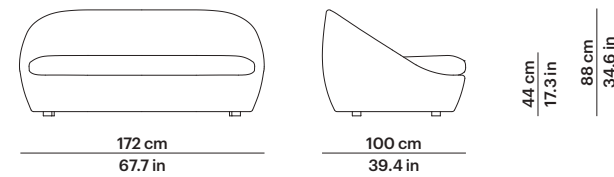

Ref. 78747

Peso Weight 50,6 Kg 111.6 lb  
m<sup>3</sup> 1,77 m<sup>3</sup>  
Cuadrantes Scatter cushions 2 (70x50 cm) (23.6x19.7 in)  
2 (40x40 cm) (15.8x15.8 in)

## SOFÁ 3 CURVO CURVED SOFA 3

Moss Brown

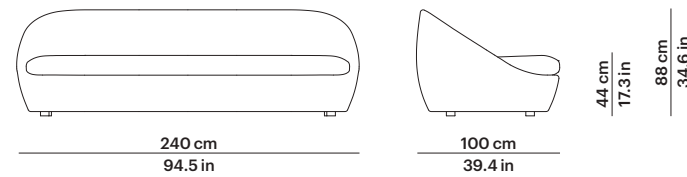

Ref. 78749

Peso Weight 66,6 Kg 146.8 lb  
m<sup>3</sup> 2,45 m<sup>3</sup>  
Cuadrantes Scatter cushions 3 (70x50 cm) (23.6x19.7 in)  
2 (40x40 cm) (15.8x15.8 in)

### Materiales y acabados Materials and finishes

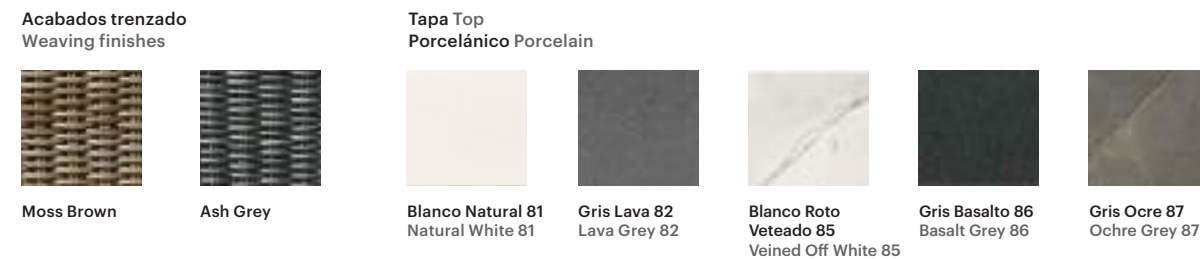
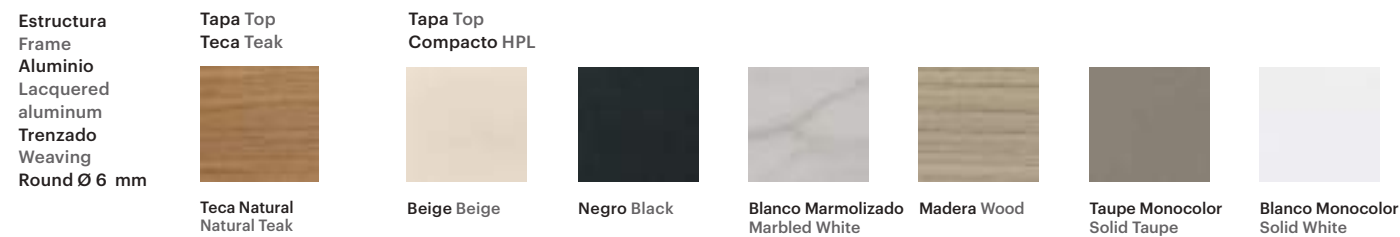

# Heritage

## TUMBONA CHAISE

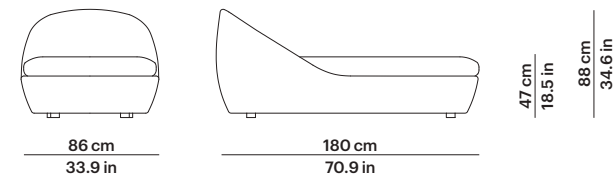

Ref. 78795

Peso Weight 39,4 Kg 86.9 lb  
m<sup>3</sup> 1,61 m<sup>3</sup>  
Cuadrantes Scatter cushions 1 (50x50 cm) (19.7x19.7 in)  
1 (40x40 cm) (15.8x15.8 in)

## TUMBONA CHAISE

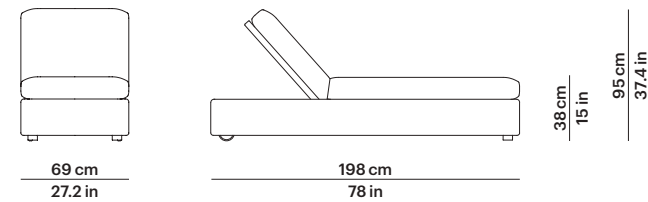

Ref. 78595

Peso Weight 38,6 Kg 85.1 lb  
m<sup>3</sup> 0,65 m<sup>3</sup>

## TUMBONA DAYBED

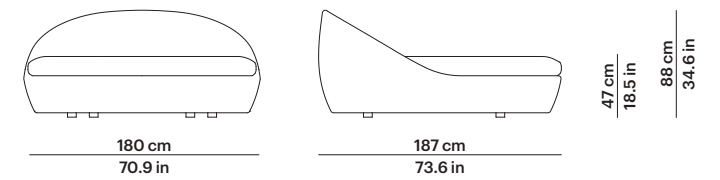

Ref. 78796

Peso Weight 66,1 Kg 145.7 lb  
m<sup>3</sup> 3,37 m<sup>3</sup>  
Cuadrantes Scatter cushions 2 (70x50 cm) (23.6x19.7 in)  
3 (40x40 cm) (15.8x15.8 in)

## TUMBONA CON BRAZOS CHAISE WITH ARMS

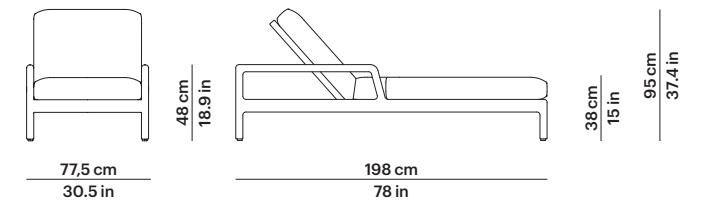

Ref. 78696

Peso Weight 38,8 Kg 85.5 lb  
m<sup>3</sup> 0,80 m<sup>3</sup>

### Materiales y acabados Materials and finishes





# Heritage

## MESA RINCÓN CUADRADA SQUARE SIDE TABLE

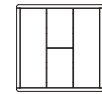
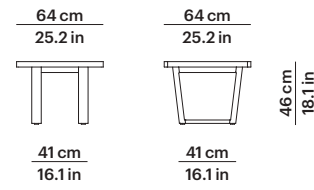

Tapa teca  
Teak top

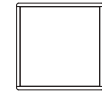

Tapa porcelánico y compacto  
Porcelain and HPL top

### Ref. 78556

**Peso Weight** 15,6 Kg con tapa teca  
34.39 lb with teak top  
27,86 Kg con tapa porcelánico  
61.41 lb with porcelain top  
22,76 Kg con tapa compacto  
50.17 lb with HPL top  
0,25 m<sup>3</sup>

## MESA AUXILIAR SIDE TABLE

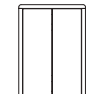
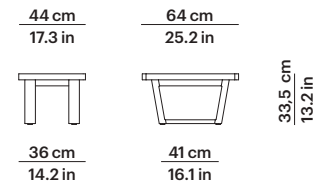

Tapa teca  
Teak top

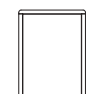

Tapa porcelánico y compacto  
Porcelain and HPL top

### Ref. 78555

**Peso Weight** 13,4 Kg con tapa teca  
29.54 lb with teak top  
22,54 Kg con tapa porcelánico  
49.70 lb with porcelain top  
19,16 Kg con tapa compacto  
42.24 lb with HPL top  
0,14 m<sup>3</sup>

## Materiales y acabados Materials and finishes

### Estructura Frame



Teca Natural  
Natural Teak

### Tapa Top Compacto HPL



Beige Beige



Negro Black



Blanco Marmolizado  
Marbled White



Madera Wood



Taupe Monocolor  
Solid Taupe

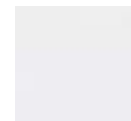

Blanco Monocolor  
Solid White

### Tapa Top Porcelánico Porcelain



Blanco Natural 81  
Natural White 81



Gris Lava 82  
Lava Grey 82



Blanco Roto  
Veteado 85  
Veined Off White 85

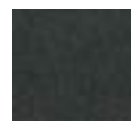

Gris Basalto 86  
Basalt Grey 86

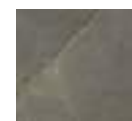

Gris Ocre 87  
Ochre Grey 87

# Heritage

## MESA CENTRO RECTANGULAR RECTANGULAR COFFEE TABLE

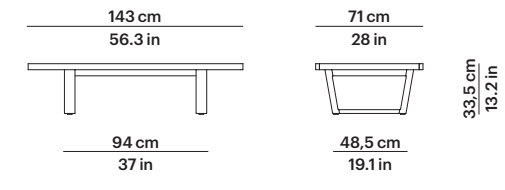

Tapa teca  
Teak top

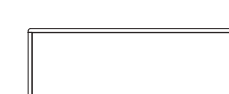

Tapa porcelánico y compacto  
Porcelain and HPL top

### Ref. 78554

**Peso Weight** 26,4 Kg con tapa teca  
58.20 lb with teak top  
53,01 Kg con tapa porcelánico  
116.86 lb with porcelain top  
39,56 Kg con tapa compacto  
87.20 lb with HPL top  
0,45 m<sup>3</sup>

## MESA CENTRO CUADRADA SQUARE COFFEE TABLE

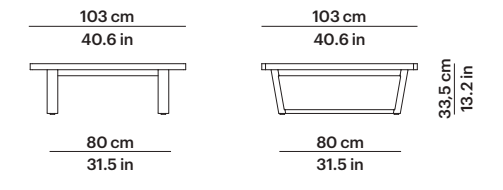

Tapa teca  
Teak top



Tapa porcelánico y compacto  
Porcelain and HPL top

### Ref. 78553

**Peso Weight** 33,6 Kg con tapa teca  
74.08 lb with teak top  
51,57 Kg con tapa porcelánico  
113.69 lb with porcelain top  
37,31 Kg con tapa compacto  
82.25 lb with HPL top  
0,47 m<sup>3</sup>

## Materiales y acabados Materials and finishes

### Estructura Frame



Teca Natural  
Natural Teak

### Tapa Top Compacto HPL



Beige Beige



Negro Black

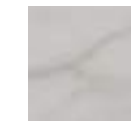

Blanco Marmolizado  
Marbled White



Madera Wood



Taupe Monocolor  
Solid Taupe

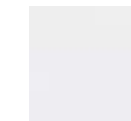

Blanco Monocolor  
Solid White

### Tapa Top Porcelánico Porcelain



Blanco Natural 81  
Natural White 81



Gris Lava 82  
Lava Grey 82



Blanco Roto  
Veteado 85  
Veined Off White 85

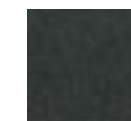

Gris Basalto 86  
Basalt Grey 86

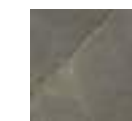

Gris Ocre 87  
Ochre Grey 87



# Heritage

## MESA COMEDOR REDONDA ROUND DINING TABLE

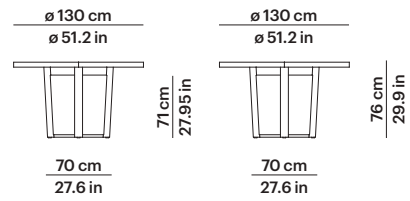

Ref. 78511

Peso Weight 43,4 Kg con tapa teca  
95.68 lb with teak top  
74,87 Kg con tapa porcelánico  
165.07 lb with porcelain top  
56,32 Kg con tapa compacto  
124.16 lb with HPL top  
m<sup>3</sup> 1,22 m<sup>3</sup>

## MESA COMEDOR CUADRADA SQUARE DINING TABLE

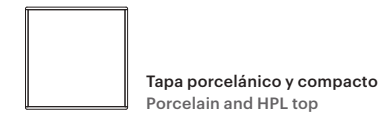
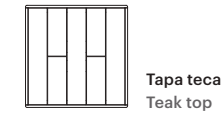
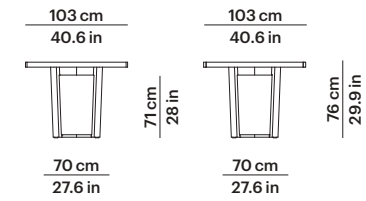

Ref. 78510

Peso Weight 41,4 Kg con tapa teca  
91.27 lb with teak top  
55,57 Kg con tapa porcelánico  
122.51 lb with porcelain top  
41,31 Kg con tapa compacto  
91.07 lb with HPL top  
m<sup>3</sup> 0,97 m<sup>3</sup>

### Materiales y acabados Materials and finishes

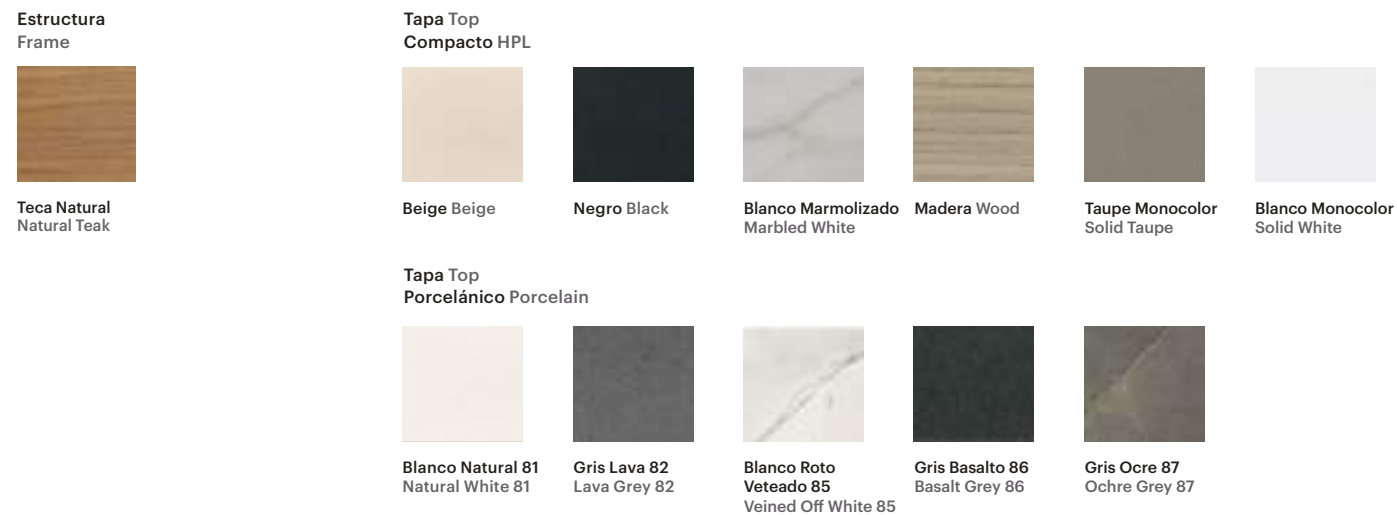

# Heritage

## MESA COMEDOR RECTANGULAR RECTANGULAR DINING TABLE

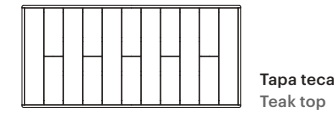
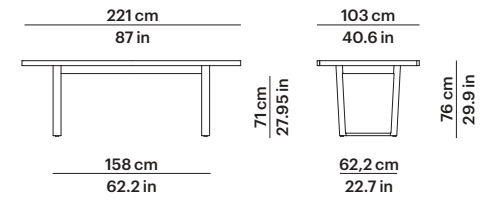

Ref. 78508

Peso Weight 78,2 Kg con tapa teca  
172.40 lb with teak top  
125,82 Kg con tapa porcelánico  
277.38 lb with porcelain top  
94,36 Kg con tapa compacto  
208.03 lb with HPL top  
m<sup>3</sup> 2,03 m<sup>3</sup>

## MESA COMEDOR RECTANGULAR RECTANGULAR DINING TABLE

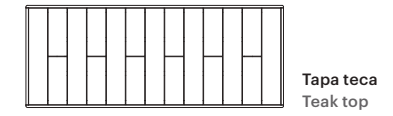
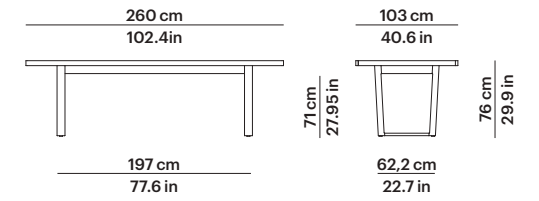

Ref. 78509

Peso Weight 84,8 Kg con tapa teca  
186.95 lb with teak top  
143,9 Kg con tapa porcelánico  
317.25 lb with porcelain top  
106,71 Kg con tapa compacto  
235.26 lb with HPL top  
m<sup>3</sup> 2,38 m<sup>3</sup>

### Materiales y acabados Materials and finishes

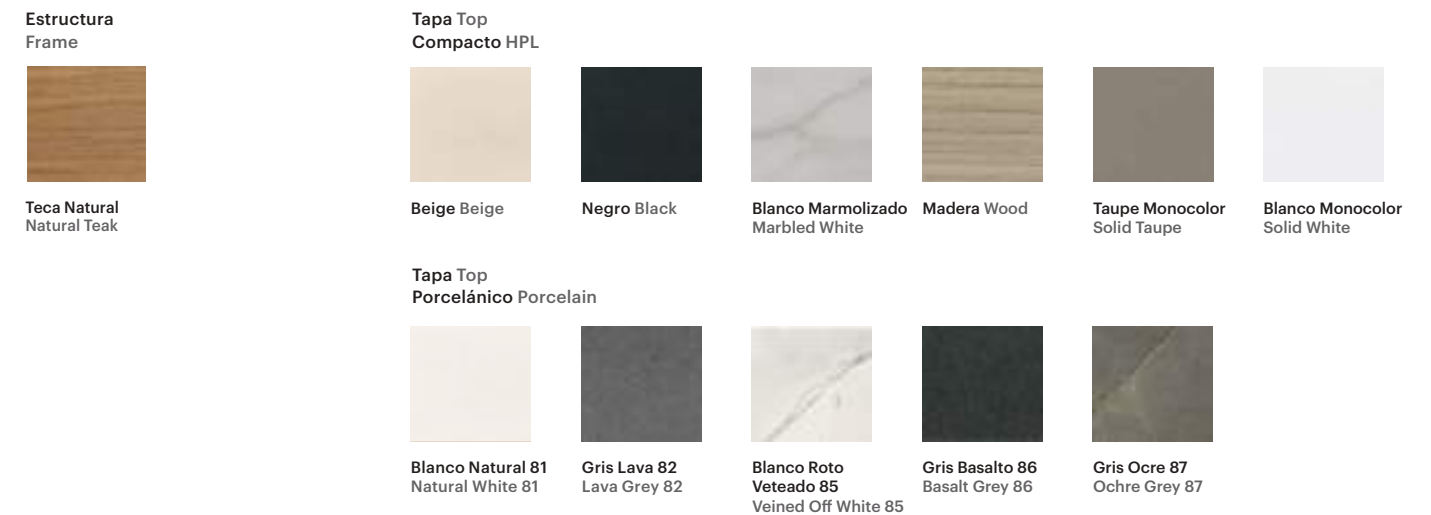



# Heritage

## MESA AUXILIAR TEJIDA WOVEN SIDE TABLE

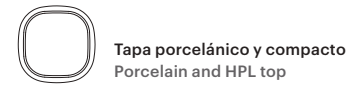
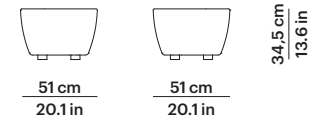

## MESA CENTRO RECTANGULAR TEJIDA RECTANGULAR WOVEN COFFEE TABLE

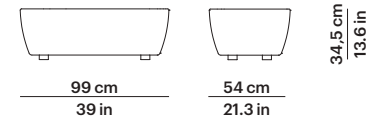

## MESA CENTRO CUADRADA TEJIDA SQUARE WOVEN COFFEE TABLE

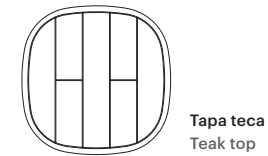
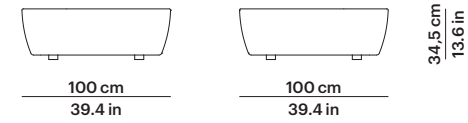

### Ref. 78756

Peso Weight **10,4 Kg** tapa teca  
22.93 lb teak top  
**11,47 Kg** tapa porcelánico  
25.28 lb porcelain top  
**9,16 Kg** tapa compacto  
20.19 lb HPL top

m<sup>3</sup> 0,13 m<sup>3</sup>

### Ref. 78755

Peso Weight **17 Kg** tapa teca  
37.48 lb teak top  
**21,63 Kg** tapa porcelánico  
47.68 lb porcelain top  
**16,23 Kg** tapa compacto  
35.79 lb HPL top











m<sup>3</sup> 0,26 m<sup>3</sup>

### Ref. 78753

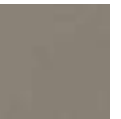
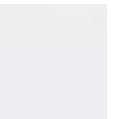
Peso Weight **29,6 Kg** tapa teca  
65.26 lb teak top  
**38,64 Kg** tapa porcelánico  
85.18 lb porcelain top  
**28,07 Kg** tapa compacto  
61.88 lb HPL top

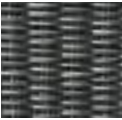
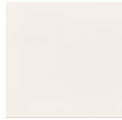
m<sup>3</sup> 0,46 m<sup>3</sup>

## Materiales y acabados Materials and finishes

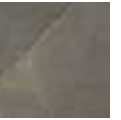
<b>Estructura</b> Frame Aluminio Lacquered aluminum <b>Trenzado</b> Weaving Round Ø 6 mm	<b>Tapa Top</b> Teca Teak  Teca Natural Natural Teak	<b>Tapa Top</b> Compacto HPL      				
	<b>Acabados trenzado</b> Weaving finishes  	<b>Tapa Top</b> Porcelánico Porcelain     				

# Jazz

## TUMBONA CHAISE

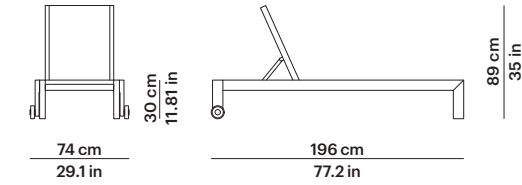

### Ref. 73995

Peso Weight **17,4 Kg** 38.4 lb  
**29,6 Kg** 65.3 lb (2 pcs)

m<sup>3</sup> 0,75 m<sup>3</sup>

## MESA AUXILIAR SIDE TABLE

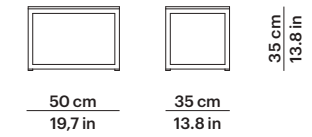

### Ref. 73958







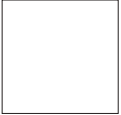
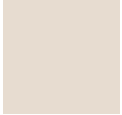

Peso Weight **12 Kg** 26 lb

m<sup>3</sup> 0,08 m<sup>3</sup>



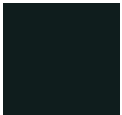

## Materiales y acabados Materials and finishes

**Estructura** Frame  
Aluminio pintado en polvo  
Powder coated aluminum

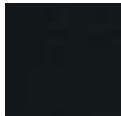

### Acabados estructuras Frame finishes

 Blanco Nieve 70 White Snow 70	 Crema 34 Cream 34	 Arena 74 Sand 74	 Óxido 75 Oxide 75	 Gris Metalizado 56 Gunmetal Grey 56
 Terracota 72 Terracotta 72	 Verde Ficus 73 Green Ficus 73	 Azul Cielo 71 Blue Sky 71	 Gris 49 Grey 49	 Negro 59 Black 59

### Acabados telas Fabrics finishes

 Batylne 35	 Batylne 37	 Batylne 38
 Batylne 57	 Batylne 39	 Batylne 40

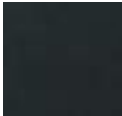
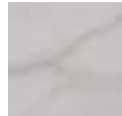
### Tapa Top Compacto HPL

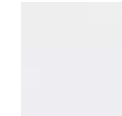
 Beige Beige	 Negro Black	 Blanco Marmolizado Marbled White	 Madera Wood	 Taupe Monocolor Solid Taupe	 Blanco Monocolor Solid White
--	--	--	--	---	--



# Khai

## SILLÓN COMEDOR ARMCHAIR

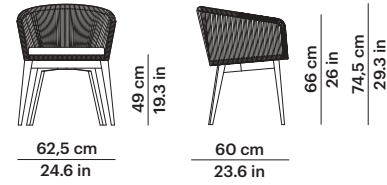

Ref. 78806

Peso Weight 12,7 Kg 28 lb  
m<sup>3</sup> 0,36 m<sup>3</sup>

### Materiales y acabados Materials and finishes

Estructura Frame  
Aluminio Lacquered aluminum  
Trenzado Weaving  
Round Ø 8 mm  
Patas Legs  
Teca natural Natural teak

Tapa Top  
Teca Teak

Acabados trenzado  
Weaving finishes



Teca Natural  
Natural Teak



Turrón  
Nougat



Taupe  
Taupe



Negro  
Black

# Lis

## PIE MESA TABLE BASE

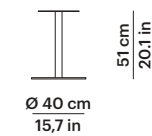

Ref. 78253

Peso Weight 12,8 Kg 28,2 lb  
m<sup>3</sup> 0,12 m<sup>3</sup>  
Medida tapa Top size  
Ø 50 - Ø 60 cm  
Ø 19.6 - Ø 23.6 in

## PIE MESA TABLE BASE

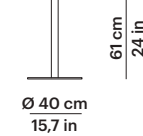

Ref. 78254

Peso Weight 13 Kg 28,7 lb  
m<sup>3</sup> 0,14 m<sup>3</sup>  
Medida tapa Top size  
Ø 50 - Ø 60 cm  
Ø 19.6 - Ø 23.6 in

### Materiales y acabados Materials and finishes

Estructura Frame  
Aluminio pintado en polvo  
Powder coated aluminum

Acabados Finishes



Blanco Nieve 70  
White Snow 70



Crema 34  
Cream 34



Arena 74  
Sand 74



Óxido 75  
Oxide 75



Taupe 60  
Taupe 60



Gris Metalizado 56  
Gunmetal Grey 56



Negro 59  
Black 59



Terracota 72  
Terracotta 72

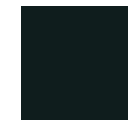

Verde Ficus 73  
Green Ficus 73



Azul Cielo 71  
Blue Sky 71

# Long Island

## SILLÓN LOUNGE CHAIR

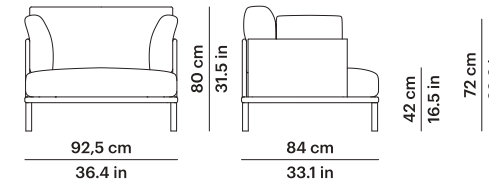

Ref. 77845

Peso Weight 29 Kg 63.9 lb  
m<sup>3</sup> 0,63 m<sup>3</sup>  
Cuadrantes Scatter cushions  
1 (55x30 cm) (21.6x11.8 in)

## SOFÁ 2 SOFA 2

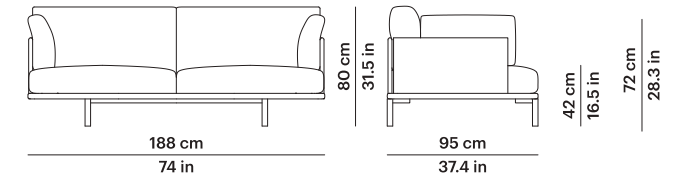

Ref. 77847

Peso Weight 52,2 Kg 115.1 lb  
m<sup>3</sup> 1,35 m<sup>3</sup>  
Cuadrantes Scatter cushions  
1 (60x35 cm) (23.6x13.7 in)  
2 (40x40 cm) (15.8x15.8 in)  
1 (50x50 cm) (19.7x19.7 in)

## SOFÁ 3 SOFA 3

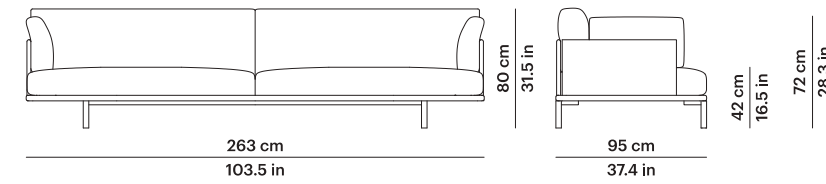

Ref. 77849

Peso Weight 83,2 Kg 183.4 lb  
m<sup>3</sup> 1,86 m<sup>3</sup>  
Cuadrantes Scatter cushions  
1 (60x35 cm) (23.6x13.7 in)  
2 (40x40 cm) (15.8x15.8 in)  
1 (50x50 cm) (19.7x19.7 in)  
1 (60x60 cm) (23.6x23.6 in)

## PUF OTTOMAN

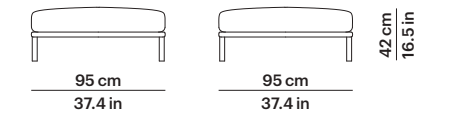

Ref. 77852

Peso Weight 23,8 Kg 52.5 lb  
m<sup>3</sup> 0,49 m<sup>3</sup>

### Materiales y acabados Materials and finishes

Estructura Frame  
Aluminio pintado en polvo  
Powder coated aluminum



Gris Metalizado 56  
Gunmetal Grey 56



Crema 34  
Cream 34



# Long Island

## SOFÁ 2 MOD. BRAZO DCHO. RIGHT ARM SECTIONAL SOFA 2

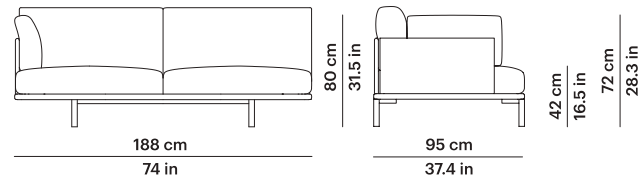

### Ref. 77840

Peso Weight	49,8 Kg 109.8 lb
m <sup>3</sup>	1,35 m <sup>3</sup>
Cuadrantes Scatter cushions	1 (60x35 cm) (23.6x13.7 in) 1 (40x40 cm) (15.8x15.8 in)

## SOFÁ 2 MOD. BRAZO IZQDO. LEFT ARM SECTIONAL SOFA 2

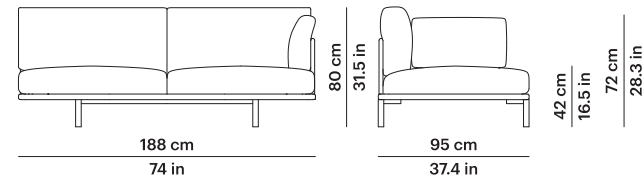

### Ref. 77841

Peso Weight	49,8 Kg 109.8 lb
m <sup>3</sup>	1,35 m <sup>3</sup>
Cuadrantes Scatter cushions	1 (60x35 cm) (23.6x13.7 in) 1 (40x40 cm) (15.8x15.8 in)

## SOFÁ 2 MOD. SIN BRAZOS ARMLESS SECTIONAL SOFA 2

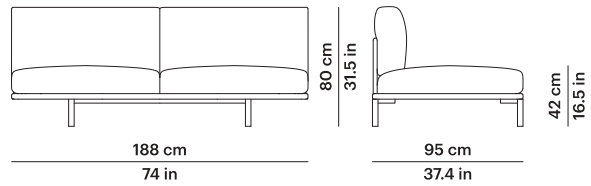

### Ref. 77846

Peso Weight	47,4 Kg 104.5 lb
m <sup>3</sup>	1,35 m <sup>3</sup>
Cuadrantes Scatter cushions	1 (60x35 cm) (23.6x13.7 in) 1 (40x40 cm) (15.8x15.8 in)

### Materiales y acabados Materials and finishes

Estructura Frame  
Aluminio pintado en polvo  
Powder coated aluminium

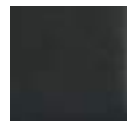

Gris Metalizado 56  
Gunmetal Grey 56



Crema 34  
Cream 34

# Long Island

## SOFÁ 3 MOD. BRAZO DCHO. RIGHT ARM SECTIONAL SOFA 3

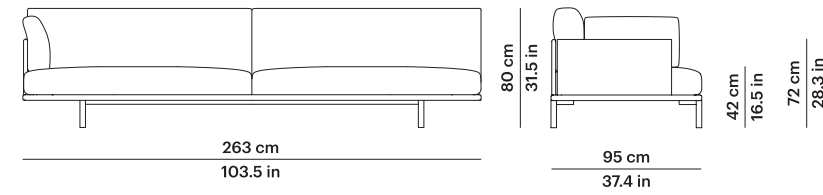

### Ref. 77842

Peso Weight	80,8 Kg 178.1 lb
m <sup>3</sup>	1,86 m <sup>3</sup>
Cuadrantes Scatter cushions	1 (60x35 cm) (23.6x13.7 in) 1 (40x40 cm) (15.8x15.8 in) 1 (50x50 cm) (19.7x19.7 in)

## SOFÁ 3 MOD. BRAZO IZQDO. LEFT ARM SECTIONAL SOFA 3

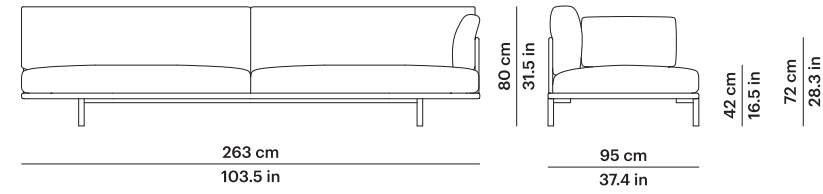

### Ref. 77843

Peso Weight	80,8 Kg 178.1 lb
m <sup>3</sup>	1,86 m <sup>3</sup>
Cuadrantes Scatter cushions	1 (60x35 cm) (23.6x13.7 in) 1 (40x40 cm) (15.8x15.8 in) 1 (50x50 cm) (19.7x19.7 in)

### Materiales y acabados Materials and finishes

Estructura Frame  
Aluminio pintado en polvo  
Powder coated aluminium



Gris Metalizado 56  
Gunmetal Grey 56



Crema 34  
Cream 34



# Long Island

## SOFÁ 3 MOD. SIN BRAZOS ARMLESS SECTIONAL SOFA 3

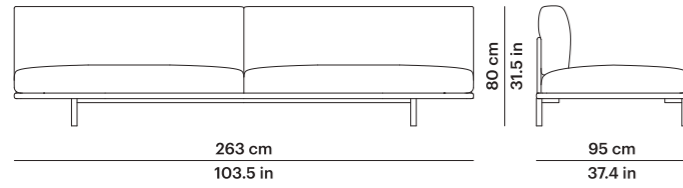

### Ref. 77848

Peso Weight 78,4 Kg 172.8 lb  
 m<sup>3</sup> 1,86 m<sup>3</sup>  
 Cuadrantes Scatter cushions  
 1 (60x35 cm) (23.6x13.7 in)  
 1 (40x40 cm) (15.8x15.8 in)  
 1 (50x50 cm) (19.7x19.7 in)

## RINCONERA CORNER

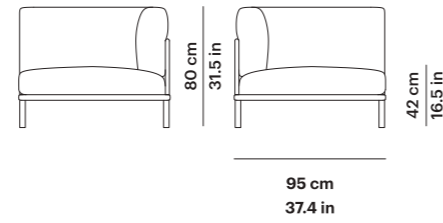

### Ref. 77844

Peso Weight 30 Kg 66.1 lb  
 m<sup>3</sup> 0,72 m<sup>3</sup>

## CHAISE LONGUE BRAZO DCHO. CHAISE LONGUE RIGHT ARM

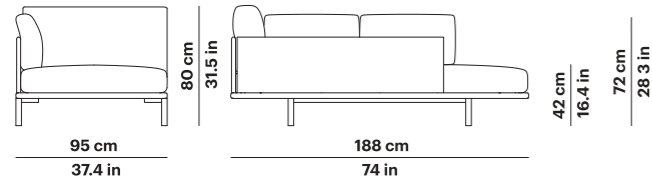

### Ref. 77896

Peso Weight 48,8 Kg 107.6 lb  
 m<sup>3</sup> 1,35 m<sup>3</sup>  
 Cuadrantes Scatter cushions  
 1 (50x50 cm) (19.7x19.7 in)  
 1 (60x60 cm) (23.6x23.6 in)

## CHAISE LONGUE BRAZO IZQDO. CHAISE LONGUE LEFT ARM

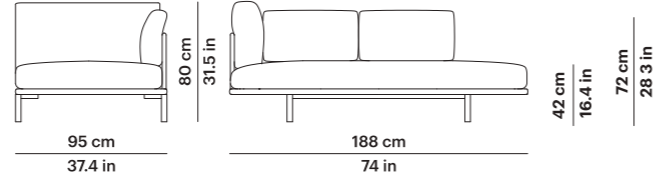

### Ref. 77897

Peso Weight 48,8 Kg 107.6 lb  
 m<sup>3</sup> 1,35 m<sup>3</sup>  
 Cuadrantes Scatter cushions  
 1 (50x50 cm) (19.7x19.7 in)  
 1 (60x60 cm) (23.6x23.6 in)

### Materiales y acabados Materials and finishes

Estructura Frame  
 Aluminio pintado en polvo  
 Powder coated aluminium

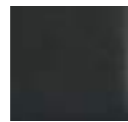

Gris Metalizado 56  
 Gunmetal Grey 56



Crema 34  
 Cream 34

# Long Island

## MESA CENTRO CUADRADA SQUARE COFFEE TABLE

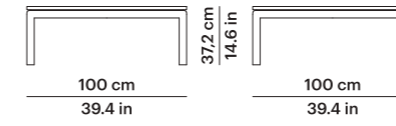

### Ref. 77853

Peso Weight 43,4 Kg con tapa porcelánico  
 95.7 lb with porcelain top  
 25 Kg con tapa compacto  
 55.1 lb with HPL top  
 m<sup>3</sup> 0,46 m<sup>3</sup>

## MESA CENTRO RECTANGULAR RECTANGULAR COFFEE TABLE

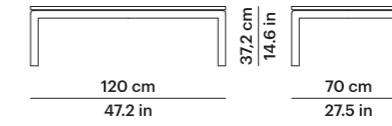

### Ref. 77854

Peso Weight 39,9 Kg con tapa porcelánico  
 88 lb with porcelain top  
 25 Kg con tapa compacto  
 55.1 lb with HPL top  
 m<sup>3</sup> 0,49 m<sup>3</sup>

## MESA RINCÓN CUADRADA SQUARE SIDE TABLE

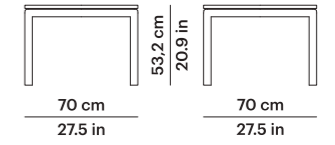

### Ref. 77856

Peso Weight 24,6 Kg con tapa porcelánico  
 54.2 lb with porcelain top  
 14,8 Kg con tapa compacto  
 32.6 lb with HPL top  
 m<sup>3</sup> 0,4 m<sup>3</sup>

### Materiales y acabados Materials and finishes

Estructura Frame  
 Aluminio pintado en polvo  
 Powder coated aluminium



Gris Metalizado 56  
 Gunmetal Grey 56



Crema 34  
 Cream 34

Tapa Top  
 Compacto HPL



Beige Beige



Negro Black

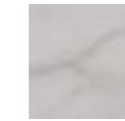

Blanco Marmolizado  
 Marbled White



Madera Wood



Taupe Monocolor  
 Solid Taupe



Blanco Monocolor  
 Solid White

Tapa Top  
 Porcelánico Porcelain



Blanco Natural 81  
 Natural White 81



Gris Lava 82  
 Lava Grey 82



Blanco Roto  
 Veteado 85  
 Veined Off White 85



Gris Basalto 86  
 Basalt Grey 86



Gris Ocre 87  
 Ochre Grey 87



# Min

## SILLÓN COMEDOR ARMCHAIR

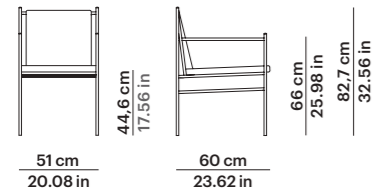

Ref. 77306

Peso Weight 10 Kg 22 lb  
m<sup>3</sup> 0,33 m<sup>3</sup>

## SILLÓN LOUNGE CHAIR

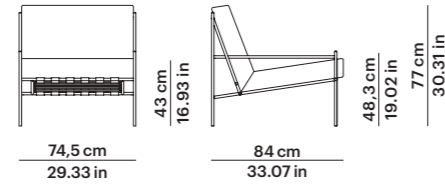

Ref. 77345

Peso Weight 16,4 Kg 36,2 lb  
m<sup>3</sup> 0,86 m<sup>3</sup>  
Cuadrantes Scatter cushions  
1 (40x40 cm) (15.8x15.8 in)

## SOFÁ 2 SOFA 2

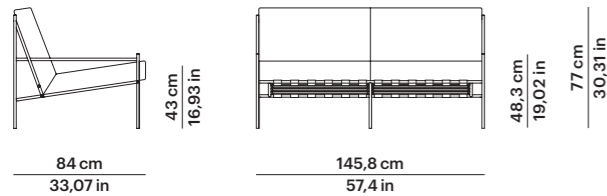

Ref. 77347

Peso Weight 27,1 Kg 59,7 lb  
m<sup>3</sup> 1,29 m<sup>3</sup>  
Cuadrantes Scatter cushions  
2 (40x40 cm) (15.8x15.8 in)

## SOFÁ 3 SOFA 3

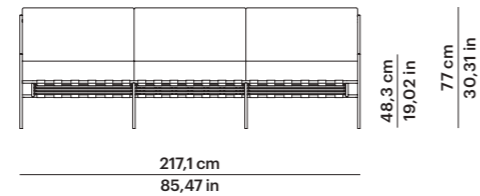

Ref. 77349

Peso Weight 36,8 Kg 81,1 lb  
m<sup>3</sup> 1,66 m<sup>3</sup>  
Cuadrantes Scatter cushions  
3 (40x40 cm) (15.8x15.8 in)

### Materiales y acabados Materials and finishes

Estructura Frame  
Aluminio pintado en polvo  
Powder coated aluminum



Blanco Nieve 70  
White Snow 70



Crema 34  
Cream 34



Arena 74  
Sand 74



Óxido 75  
Oxide 75



Negro 59  
Black 56



Gris Metalizado 56  
Gunmetal Grey 56



Terracota 72  
Terracotta 72



Verde Ficus 73  
Green Ficus 73



Azul Cielo 71  
Blue Sky 71

# Pal

## PUF OTTOMAN

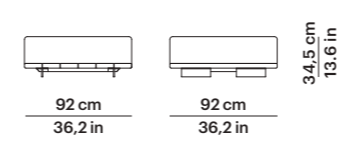

Ref. 7704400

Peso Weight 46 Kg 101.4 lb  
m<sup>3</sup> 0,39 m<sup>3</sup>

## MÓDULO CENTRO CENTRAL MODULE

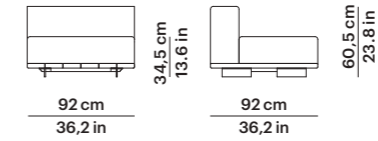

Ref. 7704500

Peso Weight 52 Kg 114.6 lb  
m<sup>3</sup> 0,64 m<sup>3</sup>

## SOFÁ 2 SOFA 2

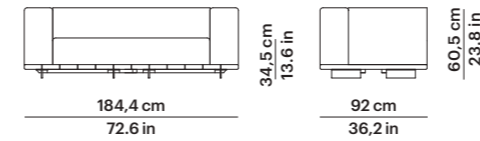

Ref. 7704700

Peso Weight 107,5 Kg 237 lb  
m<sup>3</sup> 1,24 m<sup>3</sup>  
Cuadrantes Scatter cushions  
2 (50x50 cm) (19.7x19.7 in)

## SOFÁ 3 SOFA 3

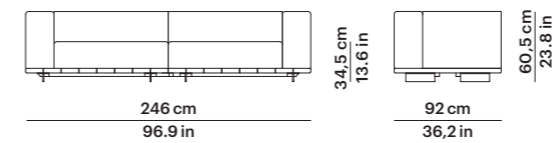

Ref. 7704900

Peso Weight 142,5 Kg 314.2 lb  
m<sup>3</sup> 1,64 m<sup>3</sup>  
Cuadrantes Scatter cushions  
2 (50x50 cm) (19.7x19.7 in)

### Materiales y acabados Materials and finishes

Estructura Frame  
Teca natural  
Natural teak  
Patas Legs  
Aluminio pintado en polvo  
Powder coated aluminum

Acabado estructura Frame finish



Teca Natural  
Natural Teak

Acabado patas Legs finish



Gris Metalizado 56  
Gunmetal Grey 56



# Pal

## BASE 92X92 + ASIENTO SINGLE SINGLE SEAT

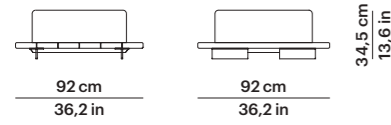

Ref. 7704505

Peso Weight 41,5 Kg 91 lb  
m<sup>3</sup> 0,64 m<sup>3</sup>

## BASE 92X92 + ASIENTO SINGLE + RESP.SINGLE + BRAZO DERECHO SINGLE SEAT & BACK + RIGHT ARM

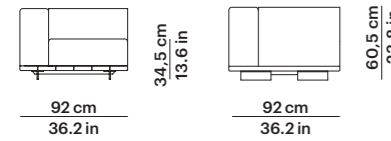

Ref. 7704504

Peso Weight 55,5 Kg 122 lb  
m<sup>3</sup> 0,64 m<sup>3</sup>

## BASE 184X92 + ASIENTO SINGLE + RESP. SINGLE + BRAZO IZQUIERDO SINGLE SEAT & BACK + LEFT ARM

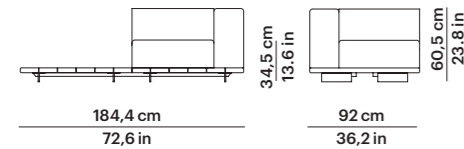

Ref. 7704705

Peso Weight 88 Kg 194 lb  
m<sup>3</sup> 0,84 m<sup>3</sup>

## BASE 92X92 + ASIENTO SINGLE + RESP. SINGLE IZQUIERDO LEFT SINGLE SEAT & BACK

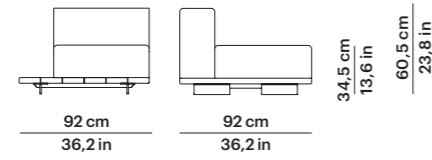

Ref. 7704502

Peso Weight 48,5 Kg 106 lb  
m<sup>3</sup> 0,64 m<sup>3</sup>

## BASE 92X92 + ASIENTO SINGLE + RESP.SINGLE + BRAZO IZQUIERDO SINGLE SEAT & BACK + LEFT ARM

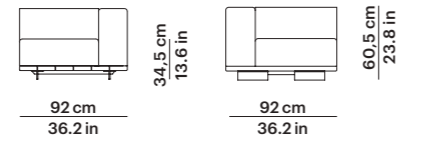

Ref. 7704503

Peso Weight 55,5 Kg 122 lb  
m<sup>3</sup> 0,64 m<sup>3</sup>

## BASE 184X92 + ASIENTO SINGLE + RESP. DOBLE DERECHA RIGHT DOUBLE SEAT & BACK

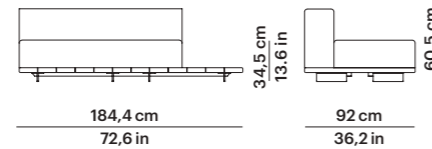

Ref. 7704701

Peso Weight 93,5 Kg 206 lb  
m<sup>3</sup> 1,26 m<sup>3</sup>  
Cuadrantes 1 (50x50 cm) (19.7x19.7 in)  
Scatter cushions

## BASE 92X92 + ASIENTO SINGLE + RESP. SINGLE DERECHO RIGHT SINGLE SEAT & BACK

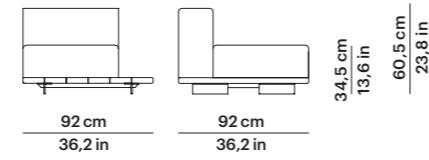

Ref. 7704501

Peso Weight 48,5 Kg 106 lb  
m<sup>3</sup> 0,64 m<sup>3</sup>

## BASE 184X92 + ASIENTO SINGLE + RESP. SINGLE + BRAZO DERECHO SINGLE SEAT & BACK + RIGHT ARM

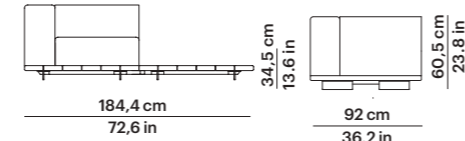

Ref. 7704706

Peso Weight 88 Kg 194 lb  
m<sup>3</sup> 0,84 m<sup>3</sup>

## BASE 184X92 + ASIENTO SINGLE + RESP. DOBLE IZQUIERDA LEFT DOUBLE SEAT & BACK

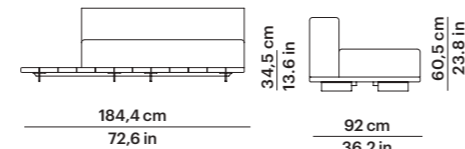

Ref. 7704702

Peso Weight 93,5 Kg 206 lb  
m<sup>3</sup> 1,26 m<sup>3</sup>  
Cuadrantes 1 (50x50 cm) (19.7x19.7 in)  
Scatter cushions

# Pal

## BASE 184X92 + ASIENTO DOBLE + RESP.DOBLE CENTRO CENTER SEAT & BACK

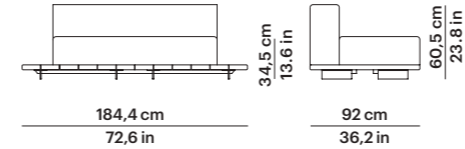

Ref. 7704709

Peso Weight 90,5 Kg 199 lb  
m<sup>3</sup> 1,26 m<sup>3</sup>  
Cuadrantes 1 (50x50 cm) (19.7x19.7 in)  
Scatter cushions

## BASE 184X92 + ASIENTO DOBLE + RESP. DOBLE + BRAZO IZQUIERDO DOUBLE SEAT & BACK + LEFT ARM

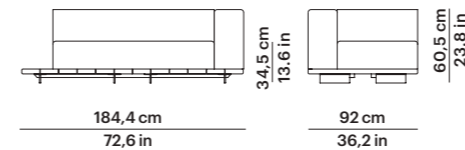

Ref. 7704707

Peso Weight 100,5 Kg 221 lb  
m<sup>3</sup> 1,26 m<sup>3</sup>  
Cuadrantes 1 (50x50 cm) (19.7x19.7 in)  
Scatter cushions

## BASE 184X92 + ASIENTO Y RESP. DOBLE + BRAZO IZQ. A LA DERECHA DOUBLE SEAT & BACK + LEFT ARM TO RIGHT

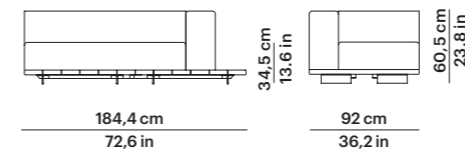

Ref. 7704710

Peso Weight 100,5 Kg 221 lb  
m<sup>3</sup> 1,26 m<sup>3</sup>  
Cuadrantes 1 (50x50 cm) (19.7x19.7 in)  
Scatter cushions

## BASE 184X92 + ASIENTO DOBLE + RESP. SINGLE + BRAZO IZQUIERDO DOUBLE SEAT + SINGLE BACK + LEFT ARM

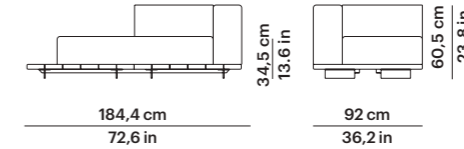

Ref. 7704703

Peso Weight 93,5 Kg 206 lb  
m<sup>3</sup> 1,26 m<sup>3</sup>  
Cuadrantes 1 (50x50 cm) (19.7x19.7 in)  
Scatter cushions

## BASE 184X92 + ASIENTO DOBLE + RESP. DOBLE + BRAZO DERECHO DOUBLE SEAT & BACK + RIGHT ARM

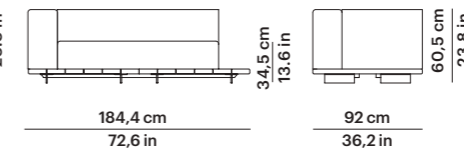

Ref. 7704708

Peso Weight 100,5 Kg 221 lb  
m<sup>3</sup> 1,26 m<sup>3</sup>  
Cuadrantes 1 (50x50 cm) (19.7x19.7 in)  
Scatter cushions

## BASE 184X92 + ASIENTO Y RESP. DOBLE + BRAZO DER. A LA IZQUIERDA DOUBLE SEAT & BACK + RIGHT ARM TO LEFT

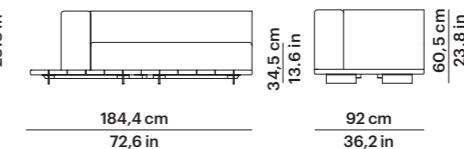

Ref. 7704711

Peso Weight 100,5 Kg 221 lb  
m<sup>3</sup> 1,26 m<sup>3</sup>  
Cuadrantes 1 (50x50 cm) (19.7x19.7 in)  
Scatter cushions

## Materiales y acabados Materials and finishes

Estructura Frame  
Teca natural  
Natural teak  
Patas Legs  
Aluminio pintado en polvo  
Powder coated aluminum

Acabado estructura Frame finish



Teca Natural  
Natural Teak

Acabado patas Legs finish

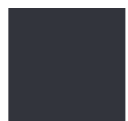

Gris Metalizado 56  
Gunmetal Grey 56



# Pal

## BASE 246X92 + ASIENTO DOBLE + RESP. DOBLE IZQUIERDO LEFT DOUBLE SEAT & BACK

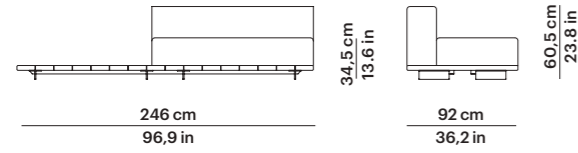

Ref. 7704902

Peso Weight 111,5 Kg 245 lb  
 m<sup>3</sup> 1,38 m<sup>3</sup>  
 Cuadrantes Scatter cushions 1 (50x50 cm) (19.7x19.7 in)

## BASE 246X92 + ASIENTO DOBLE + RESP. DOBLE DERECHO RIGHT DOUBLE SEAT & BACK

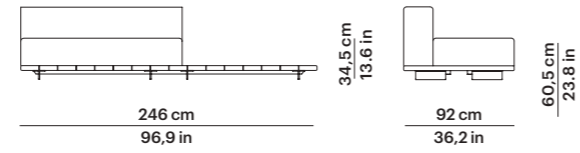

Ref. 7704901

Peso Weight 111,5 Kg 245 lb  
 m<sup>3</sup> 1,38 m<sup>3</sup>  
 Cuadrantes Scatter cushions 1 (50x50 cm) (19.7x19.7 in)

## BASE 246X92 + ASIENTO DOBLE + RESP. DOBLE + BRAZO IZQUIERDO DOUBLE SEAT & BACK + LEFT ARM

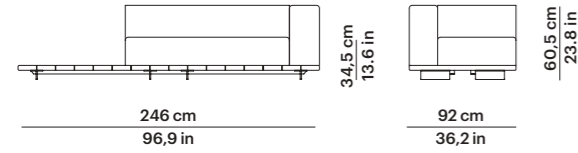

Ref. 7704904

Peso Weight 118,5 Kg 261 lb  
 m<sup>3</sup> 1,38 m<sup>3</sup>  
 Cuadrantes Scatter cushions 1 (50x50 cm) (19.7x19.7 in)

## BASE 246X92 + ASIENTO DOBLE + RESP. DOBLE + BRAZO DERECHO DOUBLE SEAT & BACK + RIGHT ARM

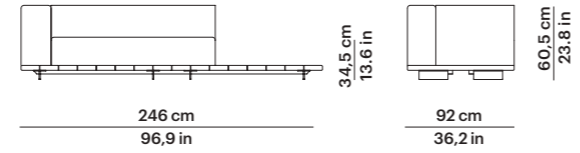

Ref. 7704903

Peso Weight 118,5 Kg 261 lb  
 m<sup>3</sup> 1,38 m<sup>3</sup>  
 Cuadrantes Scatter cushions 1 (50x50 cm) (19.7x19.7 in)

## BASE 246X92 + ASIENTO Y RESPALDO DOBLE + ASIENTO Y RESPALDO SINGLE IZQUIERDO LEFT DOUBLE SEAT & BACK + SINGLE SEAT & BACK

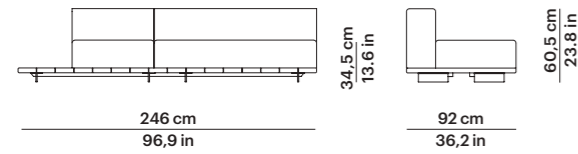

Ref. 7704907

Peso Weight 128,5 Kg 283 lb  
 m<sup>3</sup> 1,84 m<sup>3</sup>  
 Cuadrantes Scatter cushions 1 (50x50 cm) (19.7x19.7 in)

## BASE 246X92 + ASIENTO Y RESPALDO DOBLE + ASIENTO Y RESPALDO SINGLE DERECHO RIGHT DOUBLE SEAT & BACK + SINGLE SEAT & BACK

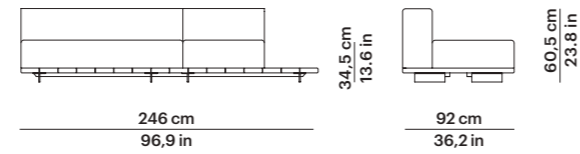

Ref. 7704908

Peso Weight 128,5 Kg 283 lb  
 m<sup>3</sup> 1,84 m<sup>3</sup>  
 Cuadrantes Scatter cushions 1 (50x50 cm) (19.7x19.7 in)

### Materiales y acabados Materials and finishes

Estructura Frame  
 Teca natural  
 Natural teak  
 Patas Legs  
 Aluminio pintado en polvo  
 Powder coated aluminum

Acabado estructura Frame finish



Teca Natural  
 Natural Teak

Acabado patas Legs finish



Gris Metalizado 56  
 Gunmetal Grey 56

# Pal

## BASE 246X92 + ASIENTO Y RESPALDO DOBLE + ASIENTO SINGLE + BRAZO IZQUIERDO DOUBLE SEAT & BACK + SINGLE SEAT + LEFT ARM

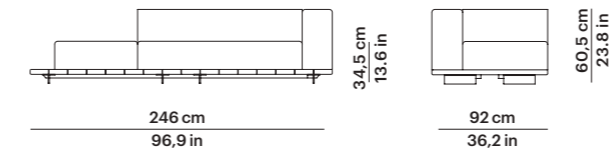

Ref. 7704909

Peso Weight 128,5 Kg 283 lb  
 m<sup>3</sup> 1,84 m<sup>3</sup>  
 Cuadrantes Scatter cushions 1 (50x50 cm) (19.7x19.7 in)

## BASE 246X92 + ASIENTO Y RESP. DOBLE + ASIENTO Y RESP. SINGLE + BRAZO IZQUIERDO DOUBLE SEAT & BACK + SINGLE SEAT & BACK + LEFT ARM

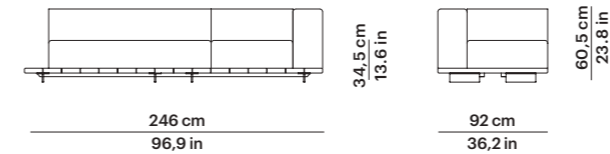

Ref. 7704905

Peso Weight 135,5 Kg 298 lb  
 m<sup>3</sup> 1,84 m<sup>3</sup>  
 Cuadrantes Scatter cushions 1 (50x50 cm) (19.7x19.7 in)

## BASE 246X92 + SOFÁ 2 COMPLETO DERECHA RIGHT COMPLETE SOFA 2

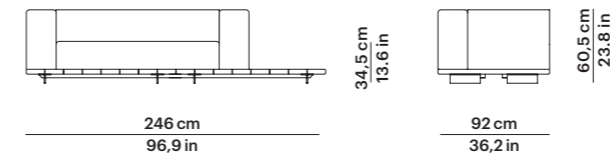

Ref. 7704911

Peso Weight 120 Kg 264 lb  
 m<sup>3</sup> 1,35 m<sup>3</sup>  
 Cuadrantes Scatter cushions 1 (50x50 cm) (19.7x19.7 in)

## BASE 246X92 + ASIENTO Y RESPALDO DOBLE + ASIENTO SINGLE + BRAZO DERECHO DOUBLE SEAT & BACK + SINGLE SEAT + RIGHT ARM

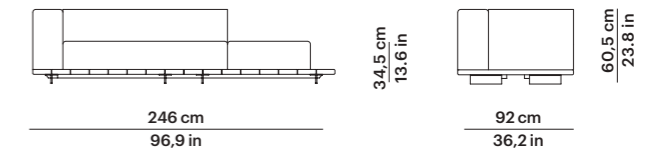

Ref. 7704910

Peso Weight 128,5 Kg 283 lb  
 m<sup>3</sup> 1,84 m<sup>3</sup>  
 Cuadrantes Scatter cushions 1 (50x50 cm) (19.7x19.7 in)

## BASE 246X92 + ASIENTO DOBLE + RESP. DOBLE + BRAZO DERECHO DOUBLE SEAT & BACK + RIGHT ARM

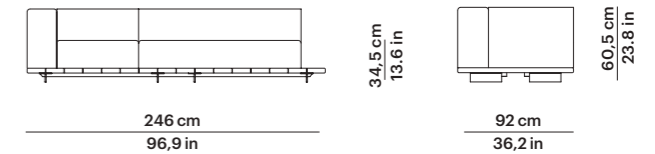

Ref. 7704906

Peso Weight 135,5 Kg 298 lb  
 m<sup>3</sup> 1,84 m<sup>3</sup>  
 Cuadrantes Scatter cushions 1 (50x50 cm) (19.7x19.7 in)

## BASE 246X92 + SOFÁ 2 COMPLETO IZQUIERDA LEFT COMPLETE SOFA 2

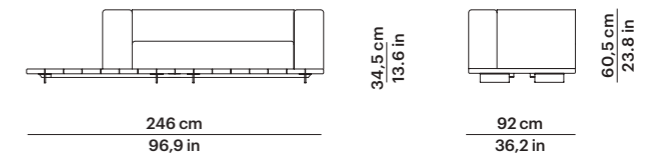

Ref. 7704912

Peso Weight 120 Kg 264 lb  
 m<sup>3</sup> 1,35 m<sup>3</sup>  
 Cuadrantes Scatter cushions 1 (50x50 cm) (19.7x19.7 in)

### Materiales y acabados Materials and finishes

Estructura Frame  
 Teca natural  
 Natural teak  
 Patas Legs  
 Aluminio pintado en polvo  
 Powder coated aluminum

Acabado estructura Frame finish



Teca Natural  
 Natural Teak

Acabado patas Legs finish



Gris Metalizado 56  
 Gunmetal Grey 56



# Pal

## BASE 246X92 + ASIENTO Y RESPALDO SINGLE IZQUIERDA + ASIENTO DOBLE BASE 246X92 + RIGHT SINGLE SEAT & BACK + DOUBLE SEAT

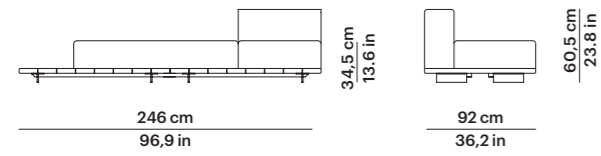

Ref. 7704913

Peso Weight	107 Kg 235 lb
m <sup>3</sup>	1,35 m <sup>3</sup>
Cuadrantes Scatter cushions	1 (50x50 cm) (19.7x19.7 in)

## BASE 246X92 + ASIENTO Y RESP. DOBLE + ASIENTO Y RESP. SIMPLE + BRAZO IZQ. A LA DERECHA DOUBLE SEAT & BACK + SINGLE SEAT & BACK + LEFT ARM TO RIGHT

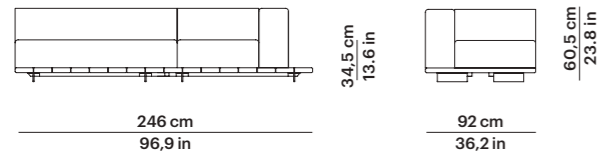

Ref. 7704915

Peso Weight	135,5 Kg 298 lb
m <sup>3</sup>	1,35 m <sup>3</sup>
Cuadrantes Scatter cushions	1 (50x50 cm) (19.7x19.7 in)

## BASE 246X92 + ASIENTO Y RESPALDO DOBLE DERECHA + ASIENTO SINGLE RIGHT DOUBLE SEAT & BACK + SINGLE SEAT

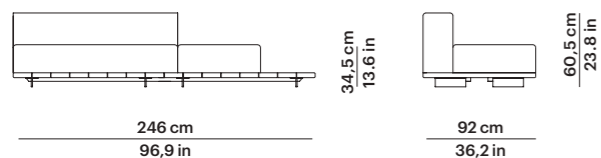

Ref. 7704917

Peso Weight	115 Kg 253 lb
m <sup>3</sup>	1,35 m <sup>3</sup>
Cuadrantes Scatter cushions	1 (50x50 cm) (19.7x19.7 in)

## BASE 246X92 + ASIENTO Y RESPALDO SINGLE DERECHA + ASIENTO DOBLE BASE 246X92 + LEFT SINGLE SEAT & BACK + DOUBLE SEAT

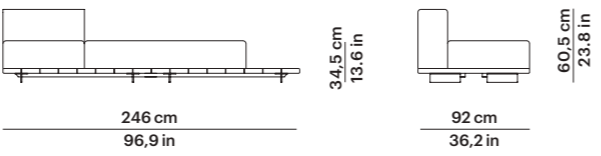

Ref. 7704914

Peso Weight	107 Kg 235 lb
m <sup>3</sup>	1,35 m <sup>3</sup>
Cuadrantes Scatter cushions	1 (50x50 cm) (19.7x19.7 in)

## BASE 246X92 + ASIENTO Y RESP. DOBLE + ASIENTO Y RESP. SIMPLE + BRAZO DCHO. A LA IZQUIERDA DOUBLE SEAT & BACK + SINGLE SEAT & BACK + RIGHT ARM TO LEFT

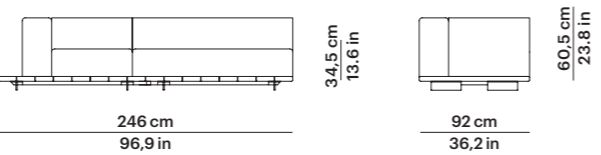

Ref. 7704916

Peso Weight	135,5 Kg 298 lb
m <sup>3</sup>	1,35 m <sup>3</sup>
Cuadrantes Scatter cushions	1 (50x50 cm) (19.7x19.7 in)

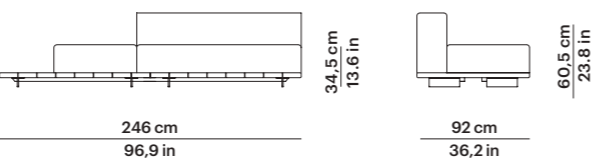

## BASE 246X92 + ASIENTO Y RESPALDO DOBLE IZQUIERDA + ASIENTO SINGLE LEFT DOUBLE SEAT & BACK + SINGLE SEAT



Ref. 7704918

Peso Weight	115 Kg 253 lb
m <sup>3</sup>	1,35 m <sup>3</sup>
Cuadrantes Scatter cushions	1 (50x50 cm) (19.7x19.7 in)

### Materiales y acabados Materials and finishes

Estructura Frame Teca natural Natural teak	Acabado estructura Frame finish		Acabado patas Legs finish	
Patas Legs Aluminio pintado en polvo Powder coated aluminum		Teca Natural Natural Teak		Gris Metalizado 56 Gunmetal Grey 56

# Pal

## BASE 185X185 + ASIENTO TUMBONA SUNBED SEAT

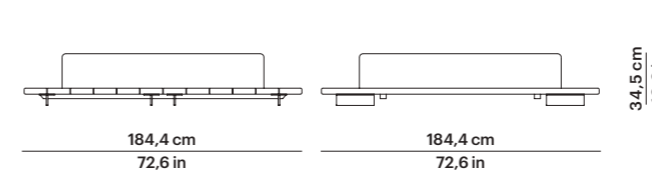

Ref. 7709502

Peso Weight	150,5 Kg 331 lb
m <sup>3</sup>	2,1 m <sup>3</sup>

## BASE 185X185 + ASIENTO TUMBONA + RESP. DOBLE + BRAZO IZQUIERDO SUNBED SEAT + DOUBLE BACK + LEFT ARM

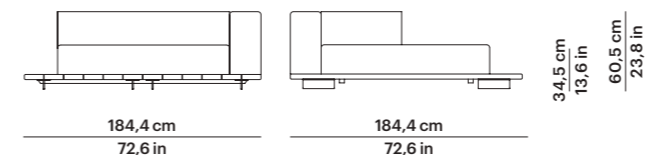

Ref. 7709503

Peso Weight	170,5 Kg 375 lb
m <sup>3</sup>	2,1 m <sup>3</sup>

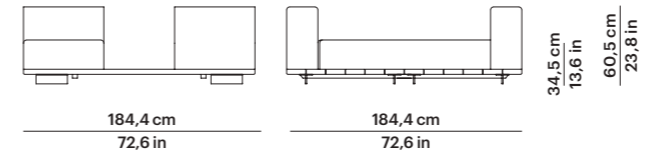

## BASE 185X185 + 2 ASIENTO DOBLE + 2 RESPALDO SINGLE VIS A VIS 2 VIS A VIS DOUBLE SEAT + SINGLE BACK



Ref. 7709505

Peso Weight	162 Kg 357 lb
m <sup>3</sup>	2,5 m <sup>3</sup>

### Materiales y acabados Materials and finishes

Estructura Frame Teca natural Natural teak	Acabado estructura Frame finish		Acabado patas Legs finish	
Patas Legs Aluminio pintado en polvo Powder coated aluminum		Teca Natural Natural Teak		Gris Metalizado 56 Gunmetal Grey 56

## BASE 185X185 + ASIENTO TUMBONA + RESP. DOBLE SUNBED SEAT + DOUBLE BACK

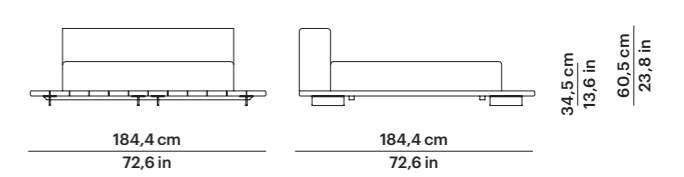

Ref. 7709501

Peso Weight	166,5 Kg 367 lb
m <sup>3</sup>	2,1 m <sup>3</sup>

## BASE 185X185 + ASIENTO TUMBONA + RESP. DOBLE + BRAZO DERECHO SUNBED SEAT + DOUBLE BACK + RIGHT ARM

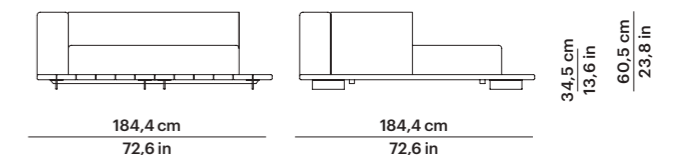

Ref. 7709504

Peso Weight	170,5 Kg 375 lb
m <sup>3</sup>	2,1 m <sup>3</sup>

## BASE 185X185 + ASIENTO DOBLE + 2 RESPALDO SINGLE PARALELOS 2 PARALLEL DOUBLE SEAT + 2 SINGLE BACK

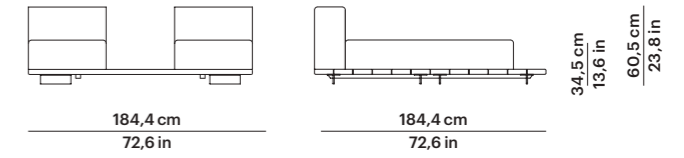

Ref. 7709506

Peso Weight	162 Kg 357 lb
m <sup>3</sup>	2,5 m <sup>3</sup>



# Pal

## MESA REDONDA 28 ROUND TABLE 28

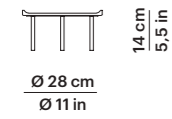

Ref. 77015

Peso Weight 4,3 Kg 9 lb  
m<sup>3</sup> 0,03 m<sup>3</sup>

## MESA REDONDA 42 ROUND TABLE 42

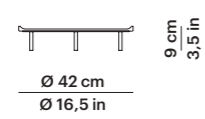

Ref. 77014

Peso Weight 7,2 Kg 15 lb  
m<sup>3</sup> 0,03 m<sup>3</sup>

## MESA RECTANGULAR 50 RECTANGULAR TABLE 50

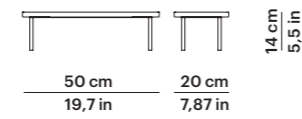

Ref. 77017

Peso Weight 5 Kg 11 lb  
m<sup>3</sup> 0,03 m<sup>3</sup>

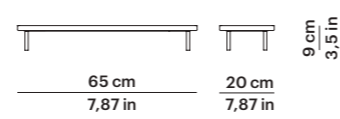

## MESA RECTANGULAR 65 RECTANGULAR TABLE 65



Ref. 77016

Peso Weight 6,8 Kg 14 lb  
m<sup>3</sup> 0,03 m<sup>3</sup>

### Materiales y acabados Materials and finishes

Tapa Top Granito Granite	Acabado tapa Top finish		Acabado patas Legs finish	
Patas Legs Aluminio pintado en polvo Powder coated aluminum		Granito Granite		Gris Metalizado 56 Gunmetal Grey 56

## MESA TAPA TECA TEAK TOP TABLE

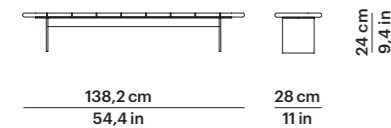

Ref. 77054

Peso Weight 16,5 Kg 36 lb  
m<sup>3</sup> 0,16 m<sup>3</sup>

## MESA TAPA TECA TEAK TOP TABLE

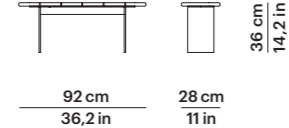

Ref. 77055

Peso Weight 14 Kg 30 lb  
m<sup>3</sup> 0,15 m<sup>3</sup>

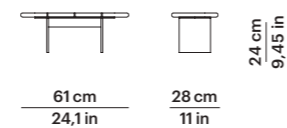

## MESA TAPA TECA TEAK TOP TABLE



Ref. 77056

Peso Weight 9 Kg 19 lb  
m<sup>3</sup> 0,11 m<sup>3</sup>

### Materiales y acabados Materials and finishes

Estructura Frame Teca natural Natural teak	Acabado estructura Frame finish		Acabado patas Legs finish	
Patas Legs Aluminio pintado en polvo Powder coated aluminum		Teca Natural Natural Teak		Gris Metalizado 56 Gunmetal Grey 56

# Pal

## MESA TAPA TECA TEAK TOP TABLE

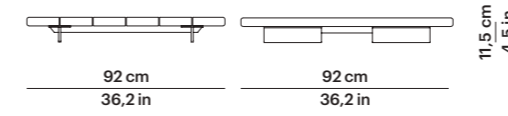

Ref. 77050

Peso Weight 31,5 Kg 69 lb  
m<sup>3</sup> 0,18 m<sup>3</sup>

## MESA TAPA TECA TEAK TOP TABLE

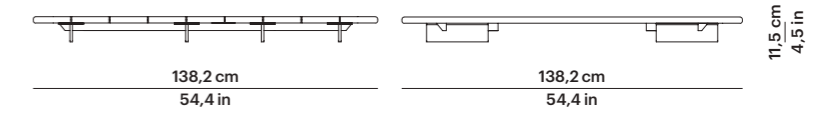

Ref. 77053

Peso Weight 51 Kg 112 lb  
m<sup>3</sup> 0,44 m<sup>3</sup>

## MESA TAPA TECA TEAK TOP TABLE

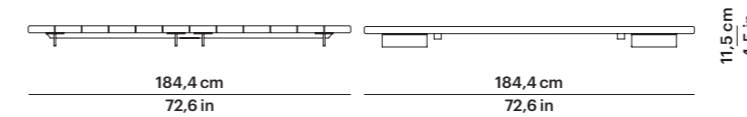

Ref. 77057

Peso Weight 115 Kg 253 lb  
m<sup>3</sup> 0,74 m<sup>3</sup>

## MESA TAPA TECA TEAK TOP TABLE

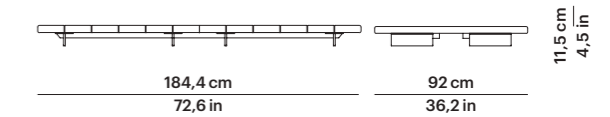

Ref. 77051

Peso Weight 64 Kg 141 lb  
m<sup>3</sup> 0,38 m<sup>3</sup>

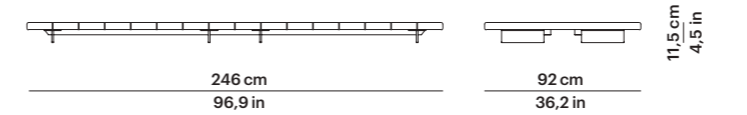

## MESA TAPA TECA TEAK TOP TABLE



Ref. 77052

Peso Weight 82 Kg 180 lb  
m<sup>3</sup> 0,5 m<sup>3</sup>

### Materiales y acabados Materials and finishes

Estructura Frame Teca natural Natural teak	Acabado estructura Frame finish		Acabado patas Legs finish	
Patas Legs Aluminio pintado en polvo Powder coated aluminum		Teca Natural Natural Teak		Gris Metalizado 56 Gunmetal Grey 56



# Paralel

## SILLA SIDE CHAIR

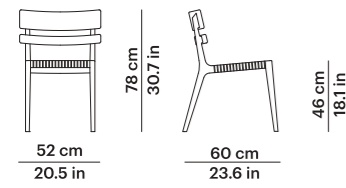

### Ref. 77601

Peso Weight 8 Kg 17.6 lb (1 pc)  
18 Kg 39.7 lb (2 pcs)  
m<sup>3</sup> 0,29 m<sup>3</sup> (1 pc) - 0,39 m<sup>3</sup> (2 pcs)

## SILLÓN COMEDOR ARMCHAIR

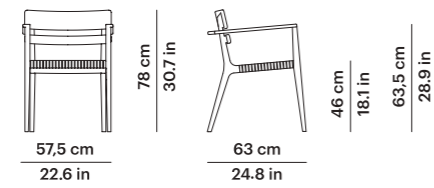

### Ref. 77606

Peso Weight 9,7 Kg 21.4 lb (1 pc)  
21 Kg 46.3 lb (2 pcs)  
m<sup>3</sup> 0,35 m<sup>3</sup> (1 pc) - 0,58 m<sup>3</sup> (2 pcs)

## TABURETE BAR STOOL

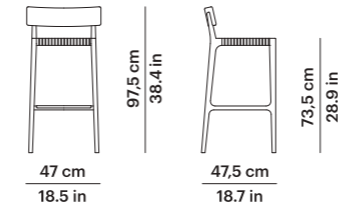

### Ref. 77652

Peso Weight 8 Kg 17.6 lb  
m<sup>3</sup> 0,26 m<sup>3</sup>

## SILLÓN CLUB CLUB SMALL LOUNGE CHAIR

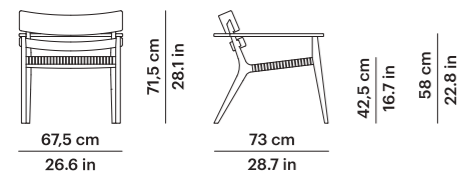

### Ref. 77605

Peso Weight 11 Kg 24.3 lb (1 pc)  
24 Kg 52.9 lb (2 pcs)  
m<sup>3</sup> 0,36 m<sup>3</sup> (1 pc) - 0,73 m<sup>3</sup> (2 pcs)

# Paralel

## SILLÓN LOUNGE CHAIR

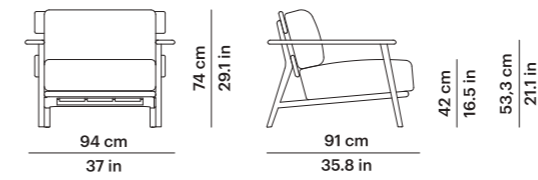

### Ref. 77645

Peso Weight 32,8 Kg 72.3 lb  
m<sup>3</sup> 0,71 m<sup>3</sup>  
Cuadrantes Scatter cushions 1 (40x40 cm) (15.8x15.8 in)

## SOFÁ 2 SOFA 2

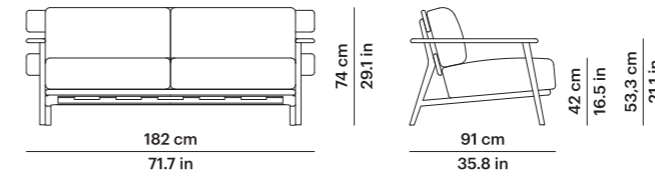

### Ref. 77647

Peso Weight 49 Kg 108 lb  
m<sup>3</sup> 1,36 m<sup>3</sup>  
Cuadrantes Scatter cushions 2 (40x40 cm) (15.8x15.8 in)

## SOFÁ 3 SOFA 3

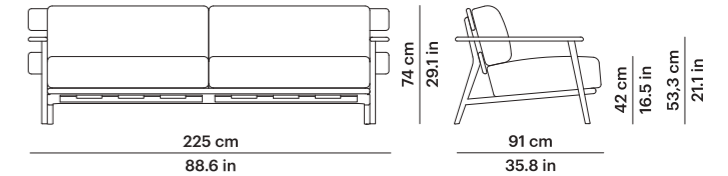

### Ref. 77649

Peso Weight 74,4 Kg 164 lb  
m<sup>3</sup> 1,67 m<sup>3</sup>  
Cuadrantes Scatter cushions 3 (40x40 cm) (15.8x15.8 in)

## Materiales y acabados Materials and finishes

### Estructura Frame



Teca Natural  
Natural Teak



Teca Weathered  
Weathered Teak

### Trenzado Weave

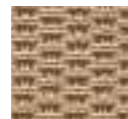

Cuerda Sintética Ø 4 mm  
Synthetic Cord Ø 4 mm

## Materiales y acabados Materials and finishes

### Estructura Frame



Teca Natural  
Natural Teak



Teca Weathered  
Weathered Teak



# Paralel

## TUMBONA CHAISE

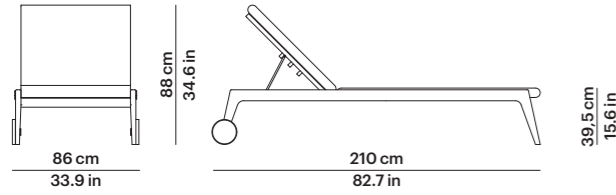

Ref. 77695

Peso Weight 36 Kg 79,4 lb  
m<sup>3</sup> 0,64 m<sup>3</sup>



## BRAZO TUMBONA ARM FOR CHAISE

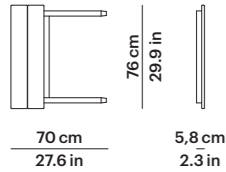

Ref. 77694

Peso Weight 5,4 Kg 11.9 lb  
m<sup>3</sup> 0,05 m<sup>3</sup>

## TUMBONA CON BRAZO CHAISE WITH ARM

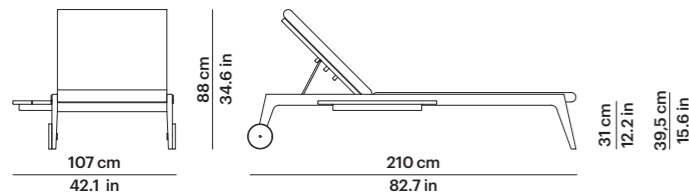

### Materiales y acabados Materials and finishes

#### Estructura Frame



Teca Natural  
Natural Teak

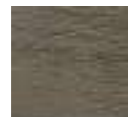

Teca Weathered  
Weathered Teak

# Paralel

## MESA CENTRO RECTANGULAR RECTANGULAR COFFEE TABLE

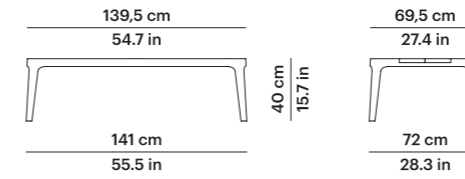

Ref. 77654

Peso Weight 25 Kg 55.1 lb  
m<sup>3</sup> 0,25 m<sup>3</sup>



## MESA RINCÓN REDONDA ROUND SIDE TABLE

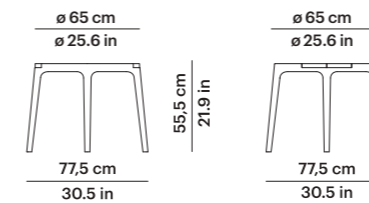

Ref. 77615

Peso Weight 13,5 Kg 29.8 lb  
m<sup>3</sup> 0,10 m<sup>3</sup>



## MESA AUXILIAR SIDE TABLE

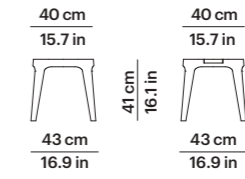

Ref. 77658

Peso Weight 7,1 Kg 0.11 lb  
m<sup>3</sup> 0,09 m<sup>3</sup>



## MESA RINCÓN CUADRADA SQUARE SIDE TABLE

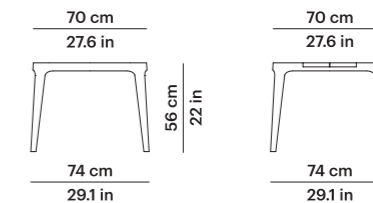

Ref. 77656

Peso Weight 17 Kg 37.5 lb  
m<sup>3</sup> 0,14 m<sup>3</sup>



### Materiales y acabados Materials and finishes

#### Estructura Frame



Teca Natural  
Natural Teak



Teca Weathered  
Weathered Teak



# Paralel

## MESA COMEDOR CUADRADA SQUARE DINING TABLE

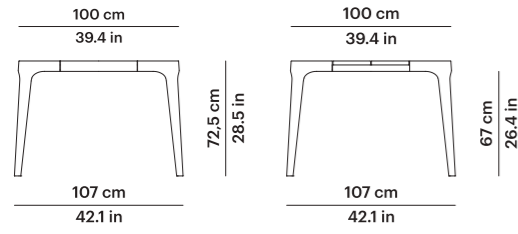

Ref. 77610

Peso Weight 37 Kg 81.6 lb  
m<sup>3</sup> 0,33 m<sup>3</sup>

## MESA COMEDOR REDONDA ROUND DINING TABLE

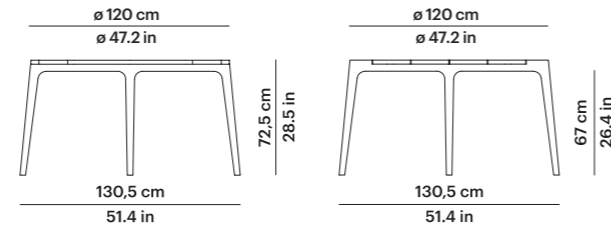

Ref. 77611

Peso Weight 37 Kg 81.6 lb  
m<sup>3</sup> 0,55 m<sup>3</sup>

### Materiales y acabados Materials and finishes

#### Estructura Frame



Teca Natural  
Natural Teak



Teca Weathered  
Weathered Teak

# Paralel

## MESA COMEDOR RECTANGULAR RECTANGULAR DINING TABLE

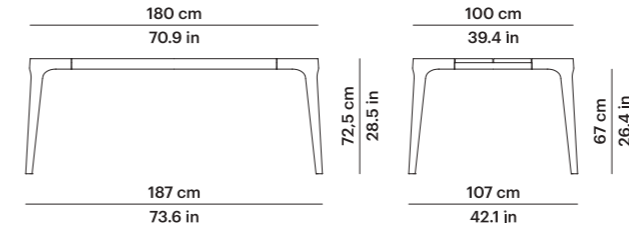

Ref. 77609

Peso Weight 58 Kg 127.9 lb  
m<sup>3</sup> 0,59 m<sup>3</sup>

## MESA COMEDOR RECTANGULAR RECTANGULAR DINING TABLE

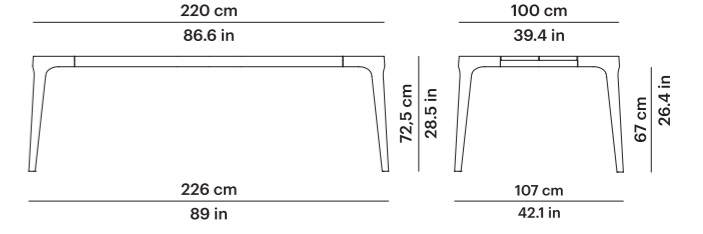

Ref. 77608

Peso Weight 66 Kg 145.5 lb  
m<sup>3</sup> 0,73 m<sup>3</sup>

## MESA COMEDOR EXTENSIBLE EXTENDABLE SQUARE DINING TABLE

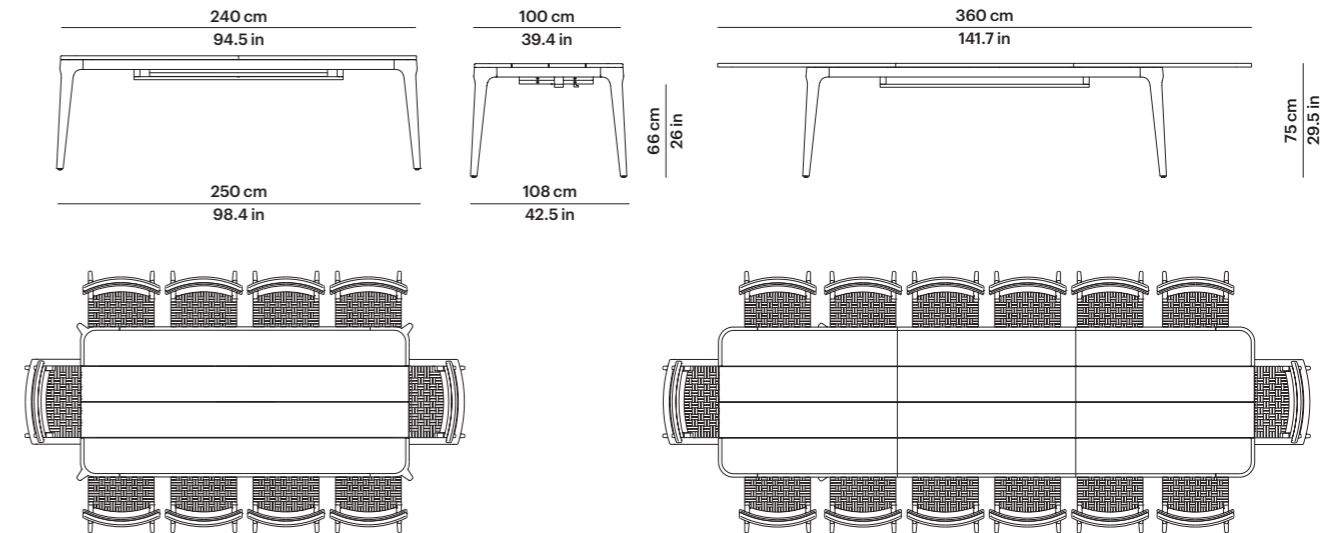

Ref. 77607

Peso Weight 120,3 Kg 265.2 lb  
m<sup>3</sup> 0,50 m<sup>3</sup>

### Materiales y acabados Materials and finishes

#### Estructura Frame



Teca Natural  
Natural Teak



Teca Weathered  
Weathered Teak



# Romantic

## TUMBONA CHAISE

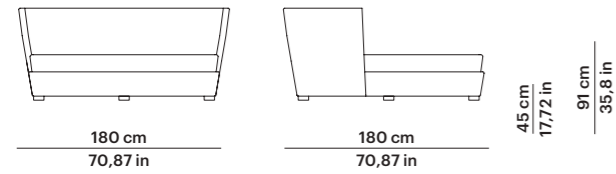

### Ref. 71697

Peso Weight	63 Kg 138 lb
m <sup>3</sup>	2,96 m <sup>3</sup>
Cuadrantes Scatter cushions	4 (60x60 cm) (23.6x23.6 in)
	3 (50x50 cm) (19.7x19.7 in)
	2 (40x40 cm) (15.8x15.8 in)

## TUMBONA CON CAPOTA CHAISE WITH CANOPY

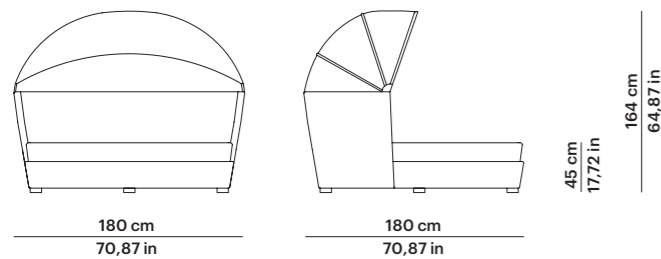

### Ref. 71698

Peso Weight	70 Kg 154 lb
m <sup>3</sup>	2,96 m <sup>3</sup>
Cuadrantes Scatter cushions	4 (60x60 cm) (23.6x23.6 in)
	3 (50x50 cm) (19.7x19.7 in)
	2 (40x40 cm) (15.8x15.8 in)

### Materiales y acabados Materials and finishes

Estructura Frame  
Aluminio lacado  
Lacquered aluminum

Trenzado Weaving  
Flat oval 6 mm

Patas Legs  
Aluminio anodizado  
Anodized aluminum

#### Acabados Finishes



Marfil 36  
Ivory 36



Tostado 03  
Toasted 03

# Round

## MESA AUXILIAR REDONDA ROUND SIDE TABLE

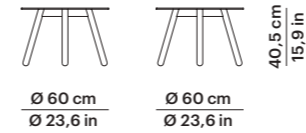

### Ref. 76557

Peso con tapa porcelánico	10,41 Kg
Weight with porcelanic top	22 lb
Peso con tapa compact	7,3 Kg
Weight with HPL top	16 lb
m <sup>3</sup>	0,22 m <sup>3</sup>

## MESA CENTRO REDONDA ROUND COFFEE TABLE

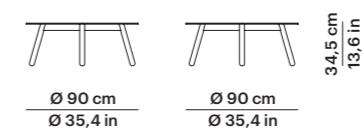

### Ref. 76555

Peso con tapa porcelánico	20,7 Kg
Weight with porcelanic top	45 lb
Peso con tapa compact	13,6 Kg
Weight with HPL top	29 lb
m <sup>3</sup>	0,35 m <sup>3</sup>

## MESA CENTRO REDONDA ROUND COFFEE TABLE

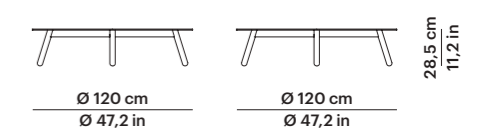

### Ref. 76553

Peso con tapa porcelánico	40 Kg
Weight with porcelanic top	88 lb
Peso con tapa compact	27,5 Kg
Weight with HPL top	60 lb
m <sup>3</sup>	0,6 m <sup>3</sup>

### Materiales y acabados Materials and finishes

Tapa Top  
Porcelánico Porcelanic  
Compacto HPL

Patas Legs  
Teca Teak

Tapa Top  
Compacto HPL



Beige Beige



Negro Black



Blanco Marmolizado  
Marbled White



Madera Wood



Taupe Monocolor  
Solid Taupe

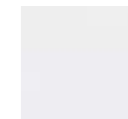

Blanco Monocolor  
Solid White

Acabado patas Legs finish



Teca Natural  
Natural Teak

Tapa Top  
Porcelánico Porcelain



Blanco Natural 81  
Natural White 81



Gris Lava 82  
Lava Grey 82



Blanco Roto 85  
Veteado  
Veined Off White

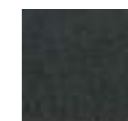

Gris Basalto 86  
Basalt Grey

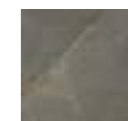

Gris Ocre 87  
Ochre Grey



# Sagra

## SILLÓN COMEDOR ARMCHAIR

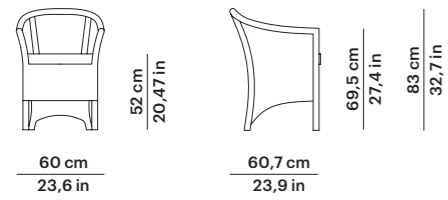

Ref. 70106

Peso Weight 11,5 Kg 25 lb  
m<sup>3</sup> 0,39 m<sup>3</sup>

### Materiales y acabados Materials and finishes

Estructura Frame  
Aluminio lacado Lacquered aluminum  
Trenzado Weaving  
Round Ø 3 mm

Acabados Finishes



Tostado O3  
Toasted O3

# Summer

## SILLA SIDE CHAIR

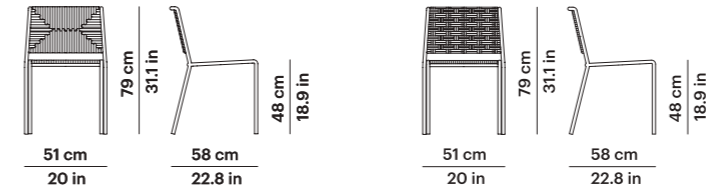

Ref. 77901

Peso Weight 11 Kg 24.2 lb (1 pc)  
36,4 Kg 80.2 lb (4 pcs)  
m<sup>3</sup> 0,34 m<sup>3</sup> (1pc)  
0,38 m<sup>3</sup> (4pcs)



## SILLÓN COMEDOR ARMCHAIR

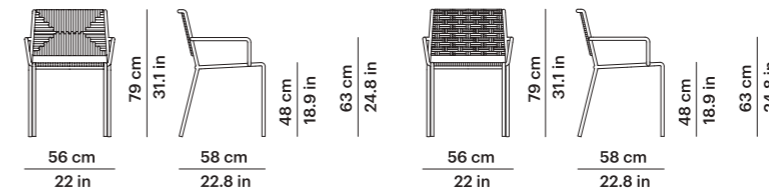

Ref. 77906

Peso Weight 11,4 Kg 25.1 lb (1 pc)  
38 Kg 83.8 lb (4 pcs)  
m<sup>3</sup> 0,32 m<sup>3</sup> (1pc)  
0,36 m<sup>3</sup> (4pcs)



### Materiales y acabados Materials and finishes

Estructura Frame  
Aluminio pintado en polvo  
Powder coated aluminium



Crema 34  
Cream 34



Gris Metalizado 56  
Gunmetal Grey 56

Trenzado Weave  
Cuerda Ø4mm  
Rope Ø4mm



Beige Beige



Gris Perlado  
Pearl Grey

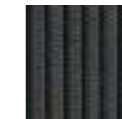

Grafito Graphite

Trenzado Weave  
Shintotex®  
Shintotex®



Blanco  
White



Gris Plata  
Silver Grey

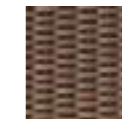

Marrón Castaño  
Chestnut Brown



Gris Oscuro  
Dark Grey



# Summer

## MESA COMEDOR CUADRADA SQUARE DINING TABLE

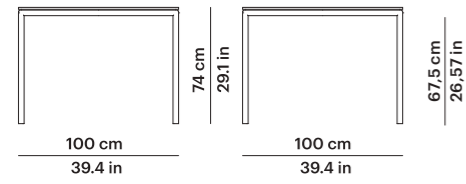

Ref. 77910

**Peso Weight** 52 Kg con tapa porcelánico  
114.6 lb with porcelain top  
41 Kg con tapa compacto  
90.4 lb with HPL top

**m³** 1,03 m³



## MESA COMEDOR RECTANGULAR RECTANGULAR DINING TABLE

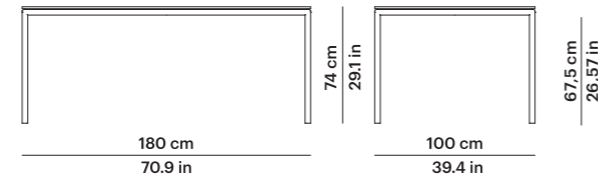

Ref. 77908

**Peso Weight** 111,7 Kg con tapa porcelánico  
246.4 lb with porcelain top  
92 Kg con tapa compacto  
202.8 lb with HPL top

**m³** 1,78 m³



## MESA COMEDOR RECTANGULAR RECTANGULAR DINING TABLE

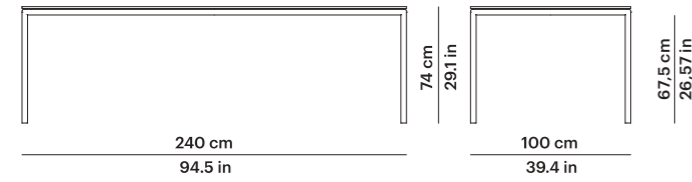

Ref. 77909

**Peso Weight** 149 Kg con tapa porcelánico  
328.5 lb with porcelain top  
122,6 Kg con tapa compacto  
270.3 lb with HPL top

**m³** 2,34 m³



### Materiales y acabados Materials and finishes

**Estructura**  
Frame

Aluminio pintado en polvo  
Powder coated aluminium

**Tapa Top**  
Compacto HPL

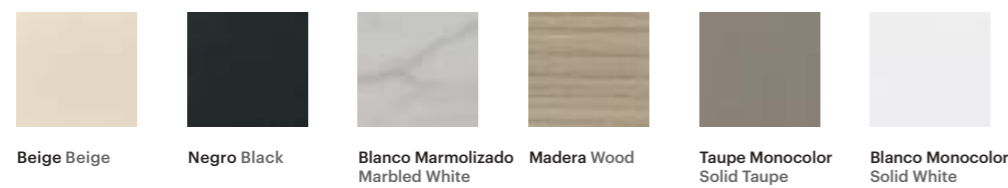

**Tapa Top**  
Porcelánico Porcelain

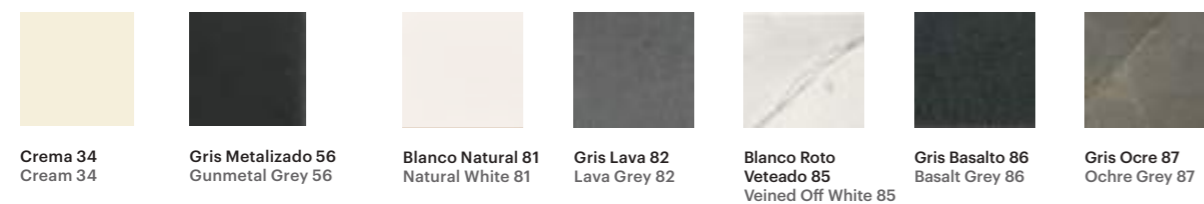

# Sunset

## TUMBONA DOBLE SIN CORTINAS DOUBLE CHAISE WITH NO CURTAINS

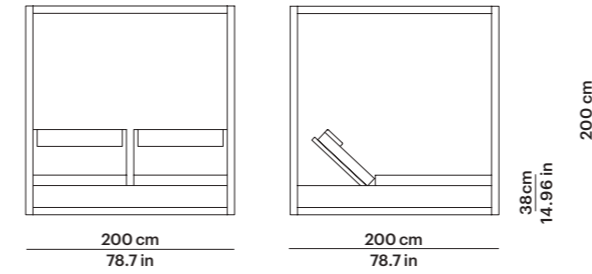

Ref. 74495

**Peso Weight** 106,5 Kg 234,8 lb

**m³** 2,57 m³

## TUMBONA DOBLE CON CORTINAS DOUBLE CHAISE WITH CURTAINS

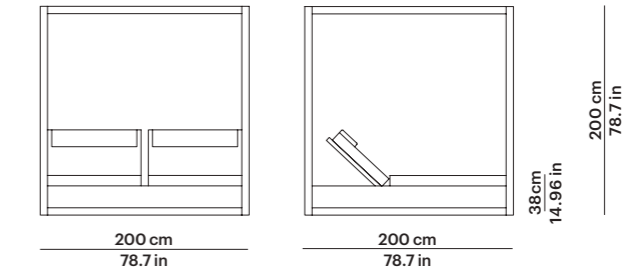

Ref. 74496

**Peso Weight** 113,5 Kg 250,2 lb

**m³** 2,57 m³

### Materiales y acabados Materials and finishes

**Estructura** Frame  
Aluminio lacado  
Lacquered aluminum

**Trenzado** Weaving  
Round ø4 mm

**Patas** Legs  
Aluminio anodizado  
Anodized aluminum

**Acabados** Finishes





# U

## SILLA SIDE CHAIR

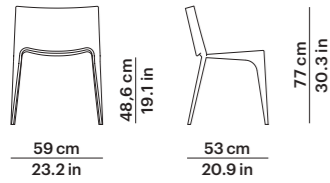

Ref. 74101

Peso Weight 8,5 Kg 18 lb (1pc)  
36 Kg 79 lb (4pc)  
m<sup>3</sup> 0,28 m<sup>3</sup> (1pc) - 0,44 m<sup>3</sup> (4pc)

## SILLÓN COMEDOR ARMCHAIR

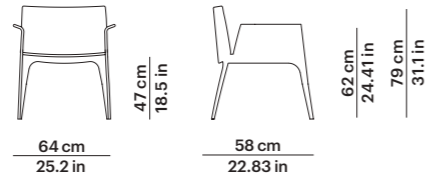

Ref. 74106

Peso Weight 9 Kg 19 lb  
m<sup>3</sup> 0,24 m<sup>3</sup>

## TUMBONA CHAISE

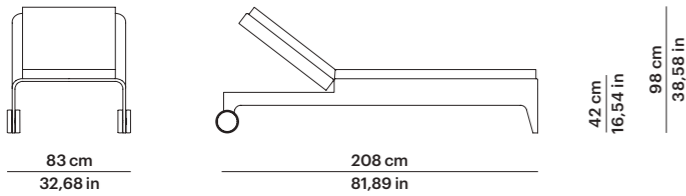

Ref. 74195

Peso Weight 25 Kg 55 lb  
m<sup>3</sup> 0,73 m<sup>3</sup>

## Materiales y acabados Materials and finishes

Estructura Frame  
Aluminio lacado Lacquered aluminum

Trenzado Weaving  
Flat oval 6 mm

Acabados Finishes

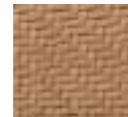

Tostado 03  
Toasted 03

# Weave

## SILLA SIDE CHAIR

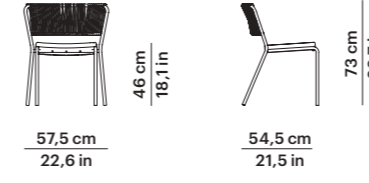

Ref. 77101

Peso Weight 7,7 Kg (1pc) 17 lb (1pc)  
24,5 Kg (4pc) 54 lb (4pc)  
m<sup>3</sup> 0,34 m<sup>3</sup> (1pc) - 0,36 m<sup>3</sup> (4pc)

## SILLÓN COMEDOR ARMCHAIR

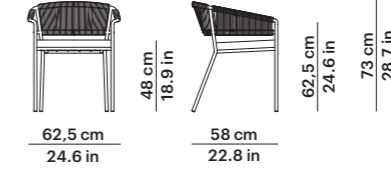

Ref. 77105

Peso Weight 10,1 Kg 22,3 lb  
24,5 Kg (4pc) 54 lb (4pc)  
m<sup>3</sup> 0,35 m<sup>3</sup>

## SILLÓN COMEDOR ARMCHAIR

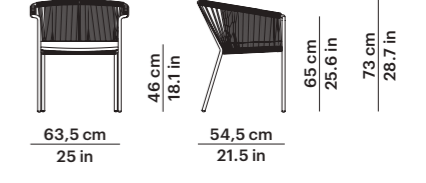

Ref. 77107

Peso Weight 12 Kg 26 lb  
m<sup>3</sup> 0,33 m<sup>3</sup>

## SILLÓN CLUB CLUB LOUNGE CHAIR

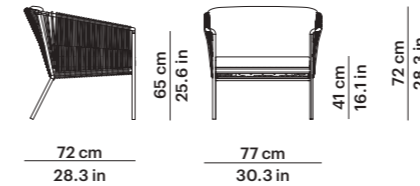

Ref. 77108

Peso Weight 16,5 Kg 36 lb  
m<sup>3</sup> 0,47 m<sup>3</sup>

## SOFÁ 2 CLUB CLUB SOFA 2

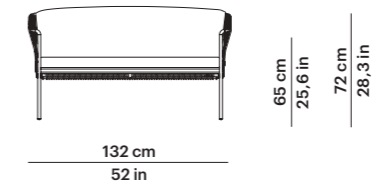

Ref. 77167

Peso Weight 23 Kg 50 lb  
m<sup>3</sup> 0,78 m<sup>3</sup>

## TABURETE BAR BAR STOOL

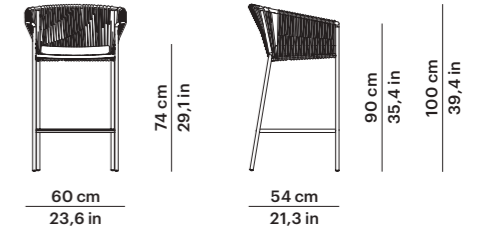

Ref. 77152

Peso Weight 13 Kg 28,7 lb  
m<sup>3</sup> 0,78 m<sup>3</sup>

## SILLÓN LOUNGE CHAIR

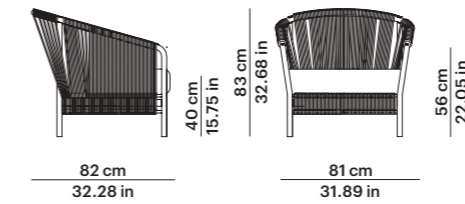

Ref. 78145

Peso Weight 23 Kg 50,6 lb  
m<sup>3</sup> 0,62 m<sup>3</sup>  
Cuadrantes 1 (40x40 cm) (15.8x15.8 in)  
Scatter cushions 1 (60x60 cm) (23.6x23.6 in)

## SOFÁ 2 SOFA 2

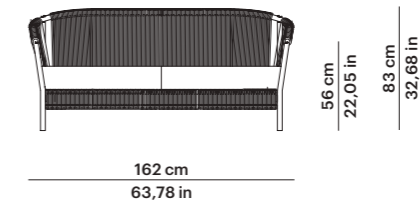

Ref. 78147

Peso Weight 44,8 Kg 98,7 lb  
m<sup>3</sup> 1,21 m<sup>3</sup>  
Cuadrantes 4 (40x40 cm) (15.8x15.8 in)  
Scatter cushions 2 (60x60 cm) (23.6x23.6 in)

## SOFÁ 3 SOFA 3

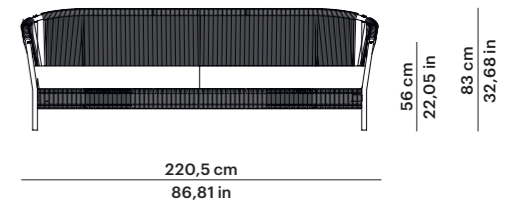

Ref. 78149

Peso Weight 48,5 Kg 106,9 lb  
m<sup>3</sup> 1,62 m<sup>3</sup>  
Cuadrantes 5 (40x40 cm) (15.8x15.8 in)  
Scatter cushions 3 (60x60 cm) (23.6x23.6 in)



# Weave

## TUMBONA REDONDA ROUND DAYBED

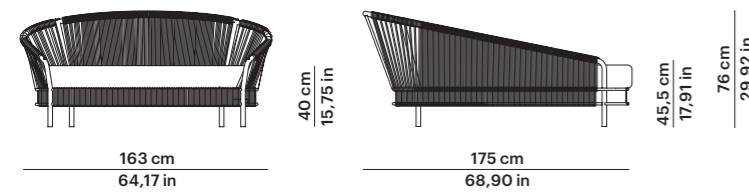

Ref. 78195

Peso Weight 72,7 Kg 160,3 lb  
m<sup>3</sup> 2,51 m<sup>3</sup>  
Cuadrantes Scatter cushions  
2 (40x40 cm) (15.8x15.8 in)  
3 (50x50 cm) (19.7x19.7 in)  
4 (60x60 cm) (23.6x23.6 in)

## SILLÓN RECLINABLE RECLINING ARMCHAIR

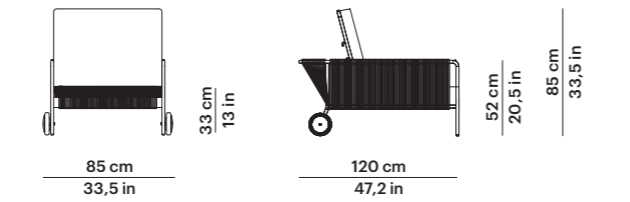

Ref. 77198

Peso Weight 30,5 Kg 67 lb  
m<sup>3</sup> 0,653 m<sup>3</sup>  
Cuadrantes Scatter cushions  
1 (40x40 cm) (15.8x15.8 in)



## PUF OTTOMAN

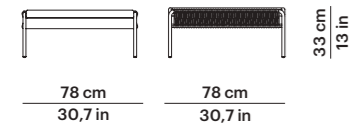

Ref. 77155

Peso Weight 15,2 Kg 33 lb  
m<sup>3</sup> 0,25 m<sup>3</sup>

## TUMBONA SUNBED

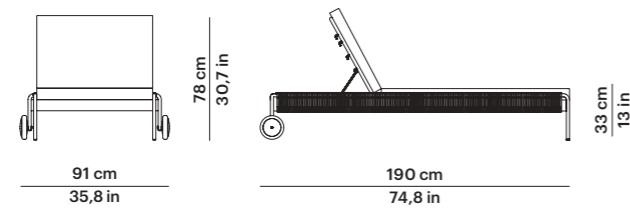

Ref. 77195

Peso Weight 42,5 Kg 93 lb  
m<sup>3</sup> 0,66 m<sup>3</sup>



## BRAZO TUMBONA CHAISE ARM

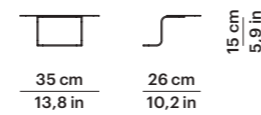

Ref. 77194

Peso Weight 2,5 Kg 5 lb  
m<sup>3</sup> 0,01 m<sup>3</sup>

# Weave

## PIE DE MESA TABLE BASE

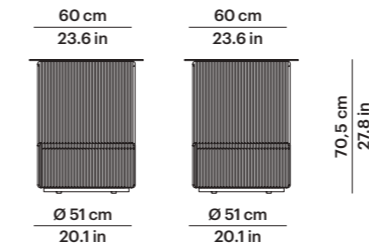

Ref. 78114

Peso Weight 37,4 Kg 82,5 lb  
m<sup>3</sup> 0,33 m<sup>3</sup>  
Medida tapa  
Top size Ø 120 - Ø 130 cm  
Ø 47,2 - Ø 51,1 in

## PIE MESA ALTO 4 PATAS HIGHT TABLE BASE 4 LEGS

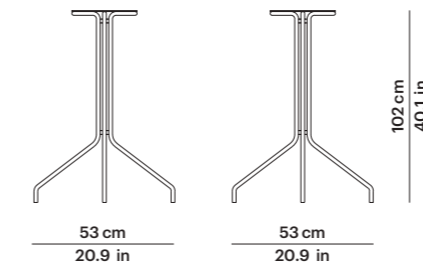

Ref. 77112

Peso Weight 12 Kg 26 lb  
m<sup>3</sup> 0,34 m<sup>3</sup>  
Medida tapa  
Top size Ø 70 - Ø 80 - Ø 90 cm  
Ø 70x70 - 80x80 - 90x90 cm  
Ø 27,6 - Ø 31,5 - Ø 35,4 in  
27,6x27,6 - 31,5x31,5 - 35,4x35,4 in

## PIE MESA 4 PATAS TABLE BASE 4 LEGS

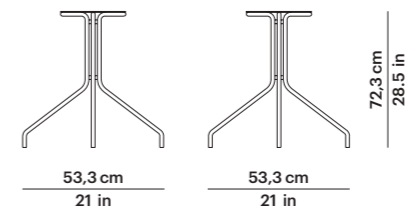

Ref. 77115

Peso Weight 10,5 Kg 23 lb  
m<sup>3</sup> 0,28 m<sup>3</sup>  
Medida tapa  
Top size Ø 70 - Ø 80 - Ø 90 cm  
Ø 70x70 - 80x80 - 90x90 cm  
Ø 27,6 - Ø 31,5 - Ø 35,4 in  
27,6x27,6 - 31,5x31,5 - 35,4x35,4 in

## PIE MESA DOBLE 4 PATAS DOUBLE TABLE BASE TOP 4 LEGS

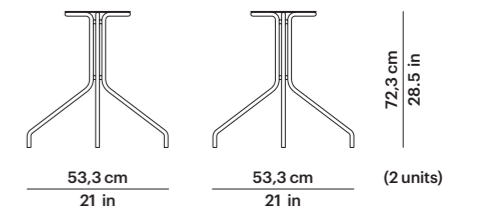

Ref. 77109

Peso Weight 21 Kg 46 lb  
m<sup>3</sup> 0,56 m<sup>3</sup>  
Medida tapa  
Top size 160x90 cm  
63x35,4 in

## Materiales y acabados Materials and finishes

Estructura Frame  
Aluminio pintado en polvo  
Powder coated aluminum  
Trenzado Weaving  
Cuerda Ø 8 mm  
Rope Ø 8 mm

### Acabados Finishes

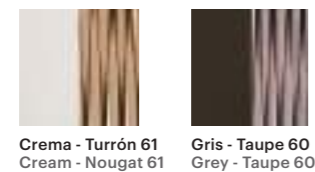

### Acabados brazo tumbona Sunbed arm finishes

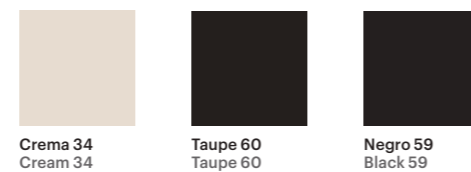

## Materiales y acabados Materials and finishes

Estructura Frame  
Aluminio pintado en polvo  
Powder coated aluminum

### Acabados Finishes

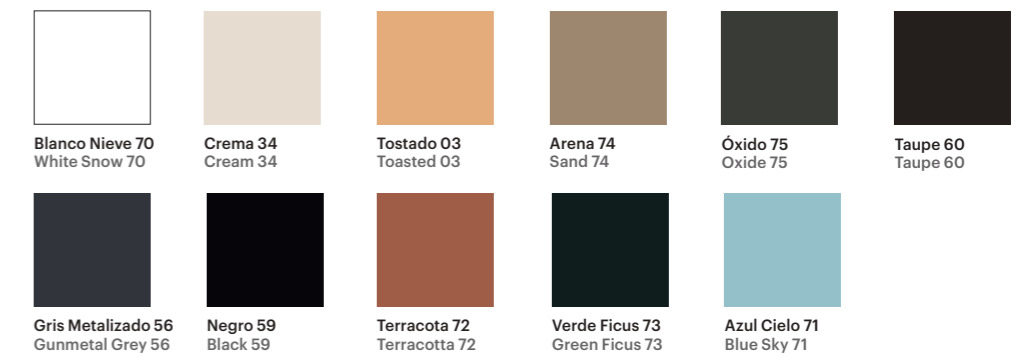



# Weave

## COLUMPIO SWING

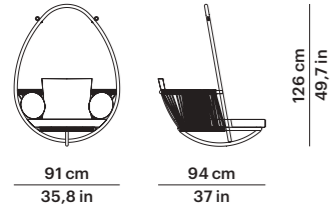

Ref. 77192

Peso Weight 16,5 Kg 36 lb  
m<sup>3</sup> 1,21 m<sup>3</sup>  
Cuadrantes 2 (Ø 32 cm) (Ø 12.6 in)  
Scatter cushions 1 (60x45 cm) (23.6x17.7 in)

## COLUMPIO CON BASE SWING WITH BASE

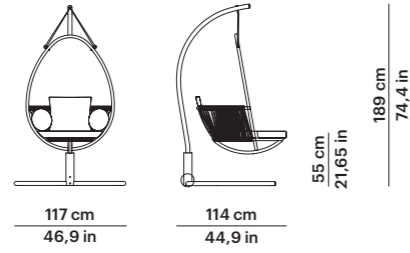

Ref. 77193

Peso Weight 32 Kg 70 lb  
m<sup>3</sup> 1,50 m<sup>3</sup>  
Cuadrantes 2 (Ø 32 cm) (Ø 12.6 in)  
Scatter cushions 1 (60x45 cm) (23.6x17.7 in)

## PUF OTTOMAN

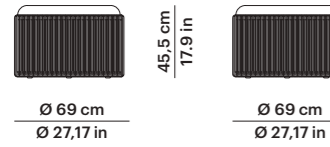

Ref. 78152

Peso Weight 14,8 Kg 32.6 lb  
m<sup>3</sup> 0,29 m<sup>3</sup>

## PUF OTTOMAN

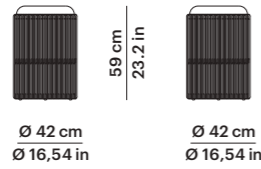

Ref. 78155

Peso Weight 9,3 Kg 20.5 lb  
m<sup>3</sup> 0,15 m<sup>3</sup>

## PUF OTTOMAN

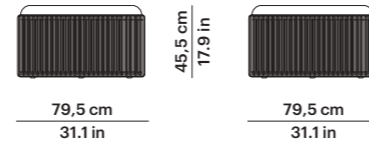

Ref. 78158

Peso Weight 20,3 Kg 44.8 lb  
m<sup>3</sup> 0,38 m<sup>3</sup>

### Materiales y acabados Materials and finishes

Estructura Frame  
Aluminio pintado en polvo  
Powder coated aluminum

Trenzado Weaving  
Cuerda Ø 8 mm  
Rope Ø 8 mm

#### Acabados Finishes



Crema - Turrón 61  
Cream - Nougat 61

Gris - Taupe 60  
Grey - Taupe 60

Negro 59  
Black 59

# Weave

## MESA CENTRO REDONDA ROUND COFFEE TABLE

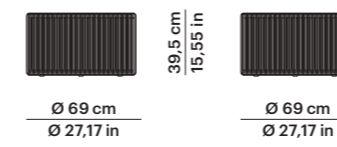

Ref. 78153

Peso Weight 21 Kg con tapa porcelánico  
46.3 lb with porcelain top  
16 Kg con tapa compacto  
35.2 lb with HPL top  
m<sup>3</sup> 0,25 m<sup>3</sup>

## MESA RINCÓN REDONDA ROUND SIDE TABLE

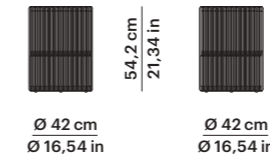

Ref. 78156

Peso Weight 10,4 Kg con tapa porcelánico  
23 lb with porcelain top  
9 Kg con tapa compacto  
19.8 lb with HPL top  
m<sup>3</sup> 0,13 m<sup>3</sup>

## MESA DE CENTRO CUADRADA SQUARE COFFEE TABLE

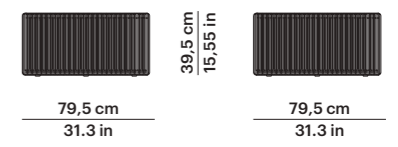

Ref. 78159

Peso Weight 30,6 Kg con tapa porcelánico  
67.5 lb with porcelain top  
22,9 Kg con tapa compacto  
50.5 lb with HPL top  
m<sup>3</sup> 0,33 m<sup>3</sup>

### Materiales y acabados Materials and finishes

Estructura Frame  
Aluminio pintado en polvo  
Powder coated aluminum

Trenzado Weaving  
Cuerda Ø 8 mm  
Rope Ø 8 mm

#### Acabados Finishes

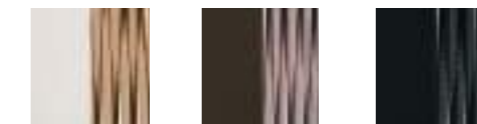

Crema - Turrón 61  
Cream - Nougat 61

Gris - Taupe 60  
Grey - Taupe 60

Negro 59  
Black 59

#### Tapa Top Compacto HPL



Beige Beige

Negro Black

Blanco Marmolizado  
Marbled White

Madera Wood

Taupe Monocolor  
Solid Taupe

Blanco Monocolor  
Solid White

#### Tapa Top Porcelánico Porcelain



Blanco Natural 81  
Natural White 81

Gris Lava 82  
Lava Grey 82

Blanco Roto  
Veteado 85  
Veined Off White 85

Gris Basalto 86  
Basalt Grey 86

Gris Ocre 87  
Ochre Grey 87



# Weave

## JARDINERA PLANTER

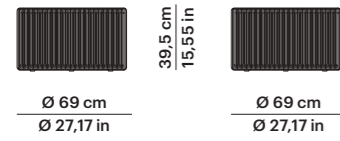

Ref. 78151

Peso Weight 13,4 Kg con cubeta  
29.5 lb with tray  
11,8 Kg sin cubeta  
26 lb without tray  
m³ 0,25 m³

## CUBETA PARA JARDINERA TRAY FOR PLANTER

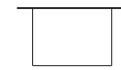

## JARDINERA PLANTER

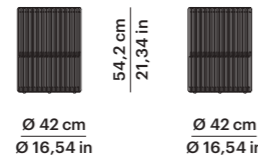

Ref. 78154

8,9 Kg con cubeta  
19.6 lb with tray  
8,3 Kg sin cubeta  
18.3 lb without tray  
0,13 m³

## CUBETA PARA JARDINERA TRAY FOR PLANTER



## JARDINERA PLANTER

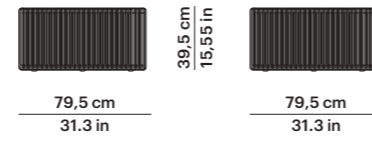

Ref. 78157

18,3 Kg con cubeta  
40.3 lb with tray  
15,7 Kg sin cubeta  
34.5 lb without tray  
0,33 m³

## CUBETA PARA JARDINERA TRAY FOR PLANTER



### Materiales y acabados Materials and finishes

Estructura Frame  
Aluminio pintado en polvo  
Powder coated aluminum

Trenzado Weaving  
Cuerda Ø 8 mm  
Rope Ø 8 mm

#### Acabados Finishes



Crema - Turrón 61  
Cream - Nougat 61

Gris - Taupe 60  
Grey - Taupe 60

Negro 59  
Black 59

#### Tapa Top Compacto HPL



Beige Beige

Negro Black

Blanco Marmolizado  
Marbled White

Madera Wood

Taupe Monocolor  
Solid Taupe

Blanco Monocolor  
Solid White

#### Tapa Top Porcelánico Porcelain



Blanco Natural 81  
Natural White 81

Gris Lava 82  
Lava Grey 82

Blanco Roto  
Veteado 85  
Veined Off White 85

Gris Basalto 86  
Basalt Grey 86

Gris Ocre 87  
Ochre Grey 87

# Tops TAPAS COMPACTOS HPL TOPS

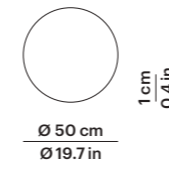

Ref. 74304

Peso Weight 3,7 Kg 8.3 lb  
m³ 0,03 m³

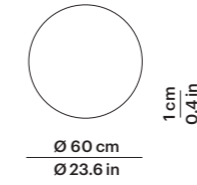

Ref. 74305

Peso Weight 5 Kg 10.9 lb  
m³ 0,04 m³

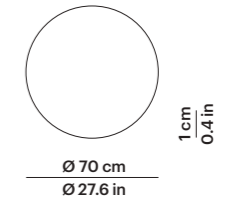

Ref. 74314

Peso Weight 6,6 Kg 14.5 lb  
m³ 0,04 m³

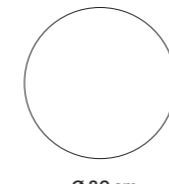

Ref. 74309

Peso Weight 8,5 Kg 18.8 lb  
m³ 0,05 m³

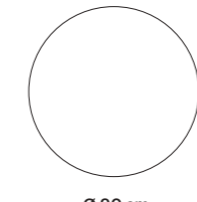

Ref. 74307

Peso Weight 10,6 Kg 23.3 lb  
m³ 0,06 m³

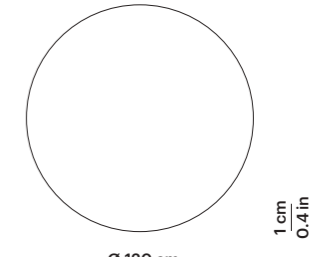

Ref. 74317

Peso Weight 17,8 Kg 39.3 lb  
m³ 0,12 m³

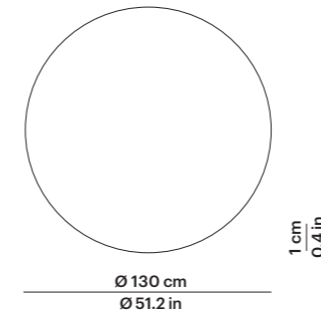

Ref. 74316

Peso Weight 20,6 Kg 45.4 lb  
m³ 0,14 m³

### Materiales y acabados Materials and finishes

#### Tapa Top Compacto HPL



Beige Beige

Negro Black

Blanco Marmolizado  
Marbled White



Madera Wood

Taupe Monocolor  
Solid Taupe

Blanco Monocolor  
Solid White



# Tops TAPAS COMPACTOS HPL TOPS

 70 cm 27.6 in 1 cm 0.4 in 70 cm 27.6 in	 80 cm 31.5 in 1 cm 0.4 in 80 cm 31.5 in	 90 cm 35.4 in 1 cm 0.4 in 90 cm 35.4 in
<b>Ref. 74315</b> Peso Weight m <sup>3</sup> 8,1 Kg 17.8 lb 0,04 m <sup>3</sup>	<b>Ref. 74310</b> Peso Weight m <sup>3</sup> 10,5 Kg 23.1 lb 0,05 m <sup>3</sup>	<b>Ref. 74311</b> Peso Weight m <sup>3</sup> 13 Kg 28.7 lb 0,06 m <sup>3</sup>

 160 cm 63 in 1 cm 0.4 in 90 cm 35.4 in
<b>Ref. 74308</b> Peso Weight m <sup>3</sup> 22,2 Kg 48.9 lb 0,11 m <sup>3</sup>

## Materiales y acabados Materials and finishes

Tapa Top  
Compacto HPL

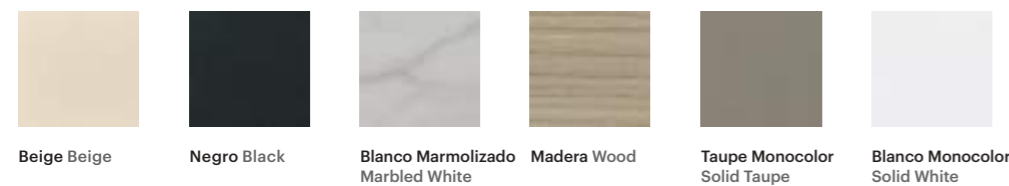

# Tops TAPAS PORCELÁNICOS PORCELAIN TOPS

 Ø 50 cm Ø 19.7 in 1,2 cm 0.5 in	 Ø 60 cm Ø 23.6 in 1,2 cm 0.5 in	 Ø 70 cm Ø 27.6 in 1,2 cm 0.5 in
<b>Ref. 74304</b> Peso Weight m <sup>3</sup> 6,7 Kg 14.8 lb 0,03 m <sup>3</sup>	<b>Ref. 74305</b> Peso Weight m <sup>3</sup> 9,2 Kg 23.6 lb 0,04 m <sup>3</sup>	<b>Ref. 74314</b> Peso Weight m <sup>3</sup> 12,4 Kg 27.2 lb 0,04 m <sup>3</sup>
 Ø 80 cm Ø 31.5 in 1,2 cm 0.5 in	 Ø 90 cm Ø 35.4 in 1,2 cm 0.5 in	 Ø 120 cm Ø 47.2 in 1,2 cm 0.5 in
<b>Ref. 74309</b> Peso Weight m <sup>3</sup> 16,1 Kg 35.4 lb 0,05 m <sup>3</sup>	<b>Ref. 74307</b> Peso Weight m <sup>3</sup> 20,1 Kg 44.2 lb 0,06 m <sup>3</sup>	<b>Ref. 74317</b> Peso Weight m <sup>3</sup> 34,8 Kg 76.7 lb 0,12 m <sup>3</sup>
 Ø 130 cm Ø 51.2 in 1,2 cm 0.5 in		
<b>Ref. 74316</b> Peso Weight m <sup>3</sup> 40,5 Kg 89.3 lb 0,14 m <sup>3</sup>		

## Materiales y acabados Materials and finishes

Tapa Top  
Porcelánico Porcelain

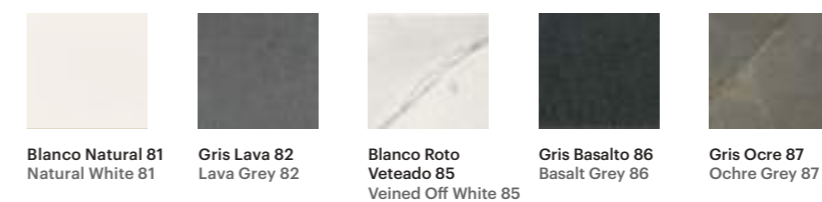



# Tops TAPAS PORCELÁNICOS PORCELAIN TOPS

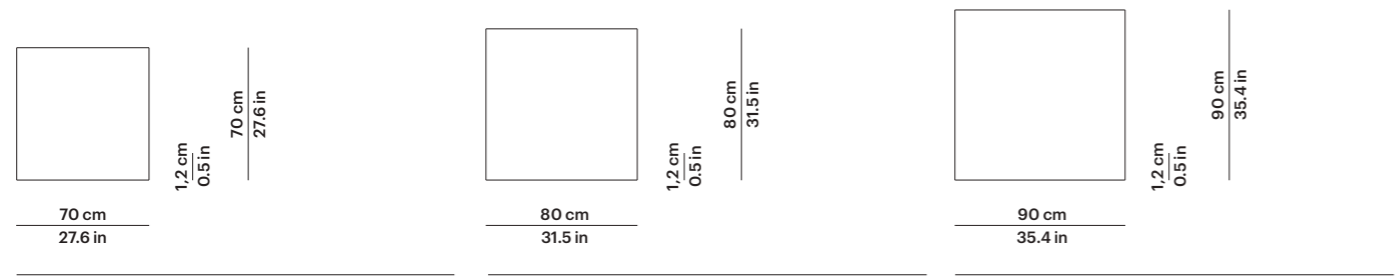

**Ref. 74315**  
 Peso Weight m<sup>3</sup> 15,4 Kg 34 lb  
 0,04 m<sup>3</sup>

**Ref. 74310**  
 Peso Weight m<sup>3</sup> 20,1 Kg 44.2 lb  
 0,05 m<sup>3</sup>

**Ref. 74311**  
 Peso Weight m<sup>3</sup> 25,2 Kg 55.4 lb  
 0,06 m<sup>3</sup>

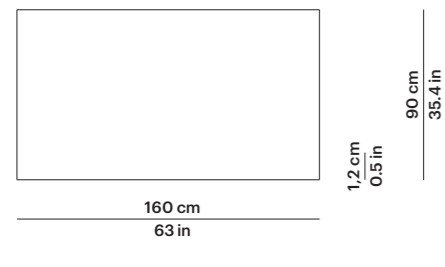

**Ref. 74308**  
 Peso Weight m<sup>3</sup> 43,8 Kg 96.5 lb  
 0,11 m<sup>3</sup>

## Materiales y acabados Materials and finishes

Tapa Top  
 Porcelánico Porcelain



# Tops TAPAS TECA TEAK TOPS

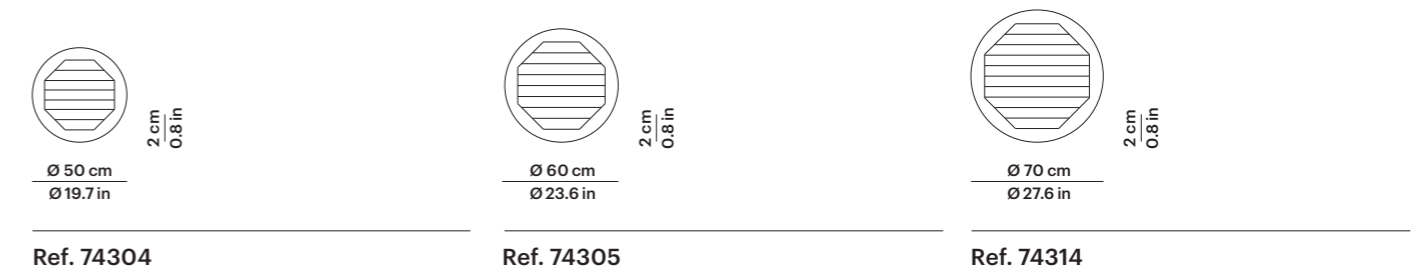

**Ref. 74304**  
 Peso Weight m<sup>3</sup> 1,8 Kg 6.3 lb  
 0,03 m<sup>3</sup>

**Ref. 74305**  
 Peso Weight m<sup>3</sup> 2,7 Kg 8 lb  
 0,04 m<sup>3</sup>

**Ref. 74314**  
 Peso Weight m<sup>3</sup> 3,6 Kg 10.6 lb  
 0,04 m<sup>3</sup>

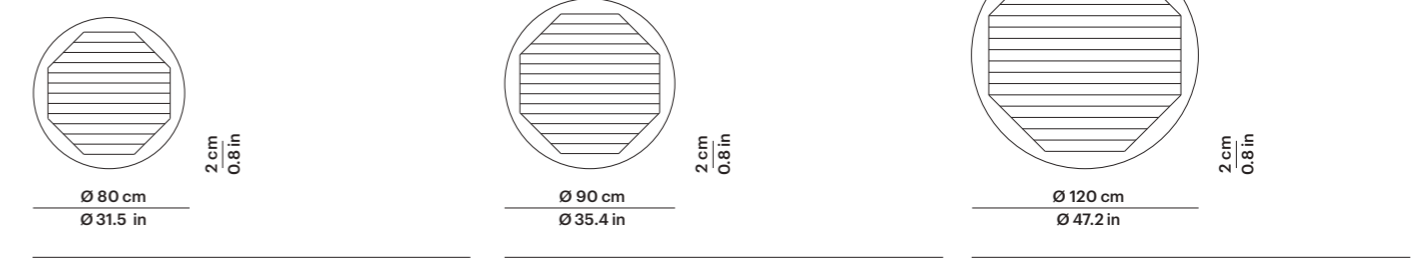

**Ref. 74309**  
 Peso Weight m<sup>3</sup> 4,6 Kg 13.4 lb  
 0,05 m<sup>3</sup>

**Ref. 74307**  
 Peso Weight m<sup>3</sup> 5,6 Kg 16 lb  
 0,06 m<sup>3</sup>

**Ref. 74317**  
 Peso Weight m<sup>3</sup> 10,1 Kg 26.6 lb  
 0,12 m<sup>3</sup>

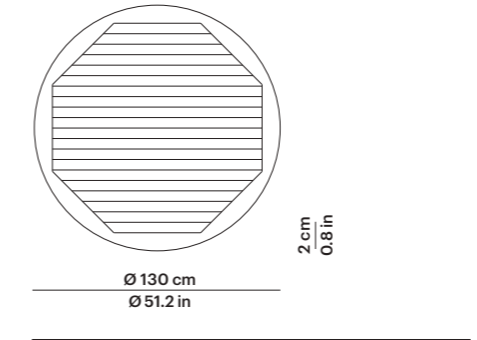

**Ref. 74316**  
 Peso Weight m<sup>3</sup> 10,4 Kg 27.6 lb  
 0,14 m<sup>3</sup>

## Materiales y acabados Materials and finishes

Estructura Frame





# Tops TAPAS TECA TEAK TOPS

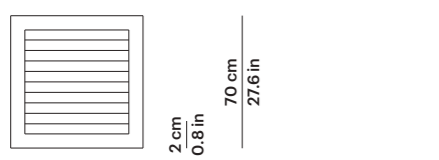

70 cm  
27.6 in

2 cm  
0.8 in

70 cm  
27.6 in

**Ref. 74314**

Peso Weight 4,6 Kg 12.8 lb  
m<sup>3</sup> 0,04 m<sup>3</sup>

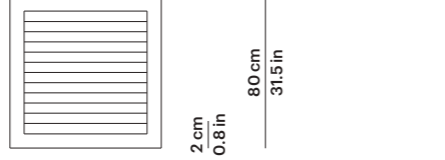

80 cm  
31.5 in

2 cm  
0.8 in

80 cm  
31.5 in

**Ref. 74309**

Peso Weight 5,9 Kg 16.2 lb  
m<sup>3</sup> 0,05 m<sup>3</sup>

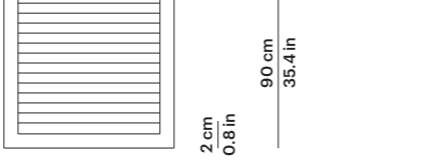

90 cm  
35.4 in

2 cm  
0.8 in

90 cm  
35.4 in

**Ref. 74307**

Peso Weight 7,2 Kg 19.5 lb  
m<sup>3</sup> 0,06 m<sup>3</sup>

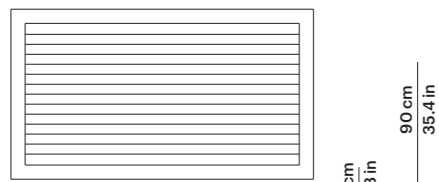

160 cm  
63 in

2 cm  
0.8 in

90 cm  
35.4 in

**Ref. 74314**

Peso Weight 12,8 Kg 32.6 lb  
m<sup>3</sup> 0,11 m<sup>3</sup>

## Materiales y acabados Materials and finishes

### Estructura Frame

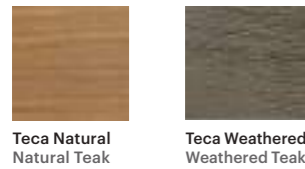

# Covers

## FUNDA ADAPTADA PARA CADA MODELO COVER ADAPTED TO EACH MODEL



**MATERIAL DE TEJIDO BASE**  
Hilo 370/540 dtex din en iso 2060  
Tejido 1/1  
Acabado Finish tratamiento fungicida, repelente a la suciedad

Peso Weight 240g/m<sup>2</sup> en iso 2286-2  
Resist. al frío Cold resist. -25°C en 1876-1  
Resist. al calor Heat resist. +70°C pa 07.04 (intern)  
Resist. a la interperie 6-8 note, value en iso 105 b04

## SÍMBOLOS SIMBOLS

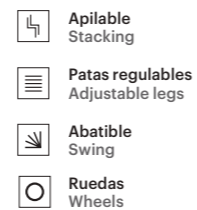

# Beach

## PARASOL UMBRELLA

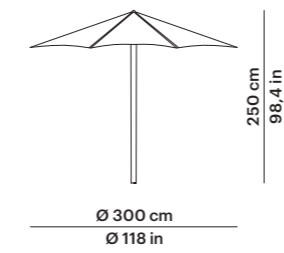

### Ref. 84602

Peso Weight 13,4 Kg 29,5 lb  
m<sup>3</sup> 0,20 m<sup>3</sup>

### Materiales Materials

**Estructura Frame**  
Aluminio lacado  
Lacquered aluminum

**Telas Fabrics**  
Grupo 1-21 Group 1-21  
Batyline

## PARASOL UMBRELLA

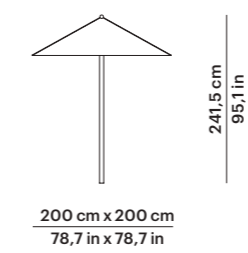

### Ref. 84601

Peso Weight 6,4 Kg 14,1 lb  
m<sup>3</sup> 0,14 m<sup>3</sup>

**Estructura Frame**  
Aluminio + varillas fibra de vidrio  
Aluminum + glass fiber ribs

**Telas Fabrics**  
Grupo 1-21 Group 1-21  
Batyline

## Materiales y acabados Materials and finishes

### Acabado estructura Frame finish



Aluminio Lacado  
Blanco  
White Lacquered  
Aluminum

### Acabados telas Fabrics finishes



Grupo 1-21  
Group 1-21



Batyline 35



Batyline 37



Batyline 38



Batyline 57



Batyline 39



Batyline 40

## BASE DE PARASOL UMBRELLA BASE

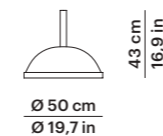

### Ref. 84603

Peso Weight 39 Kg 85 lb  
m<sup>3</sup> 0,15 m<sup>3</sup>

## BASE DE PARASOL UMBRELLA BASE



### Ref. 84604

Peso Weight 31 Kg 68 lb  
m<sup>3</sup> 0,11 m<sup>3</sup>

## Materiales y acabados Materials and finishes

**Estructura Frame**  
Aluminio lacado + hormigón  
Lacquered aluminum + concrete

**Estructura Frame**  
Base metal  
Metal base

### Acabado estructura Frame finish



Aluminio Lacado Blanco  
White Lacquered Aluminum



# Ombra

## PARASOL UMBRELLA

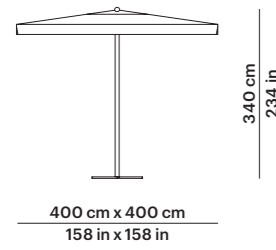

## BASE DE PARASOL UMBRELLA BASE

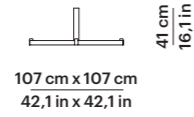

Ref. 84804

Peso Weight 194 Kg 427 lb  
m<sup>3</sup> 0,40 m<sup>3</sup>

Peso Weight 168,5 Kg 371 lb  
m<sup>3</sup> 0,16 m<sup>3</sup>

### Materiales y acabados Materials and finishes

Estructura Frame  
Aluminio lacado  
Lacquered aluminum

Acabado estructura  
Frame finish

Acabados telas  
Fabrics finishes

Telas Fabrics  
Grupo 1-21 Group 1-21  
Batylne



Aluminio Lacado Blanco  
White Lacquered Aluminum



Grupo 1-21  
Group 1-21



Batylne 35

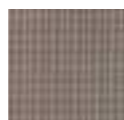

Batylne 37

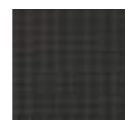

Batylne 38

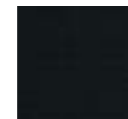

Batylne 57



Batylne 39



Batylne 40

Estructura Frame  
Aluminio lacado  
Lacquered aluminum

Materiales Materials  
4 baldosas de cerámica de 35 kg cada una  
4 ceramic tiles 77 lb each one

# Roma

## PARASOL UMBRELLA

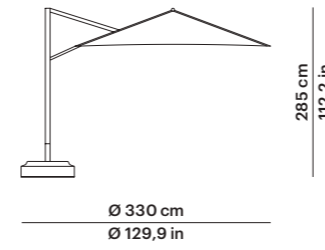

Ref. 84701

Peso Weight 56,3 Kg 124,2 lb  
m<sup>3</sup> 0,40 m<sup>3</sup>

## PARASOL UMBRELLA

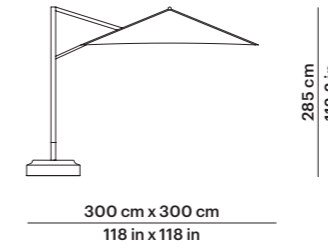

Ref. 84703

Peso Weight 64,5 Kg 142,2 lb  
m<sup>3</sup> 0,40 m<sup>3</sup>

## PARASOL UMBRELLA

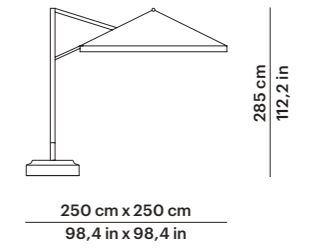

Ref. 84702

Peso Weight 58 Kg 127,9 lb  
m<sup>3</sup> 0,40 m<sup>3</sup>

### Materiales y acabados Materials and finishes

Estructura Frame  
Aluminio lacado  
Lacquered aluminum

Acabado estructura  
Frame finish

Acabados telas  
Fabrics finishes

Telas Fabrics  
Grupo 1-21 Group 1-21  
Batylne



Aluminio Lacado Blanco  
White Lacquered Aluminum



Grupo 1-21  
Group 1-21



Batylne 35



Batylne 37



Batylne 38



Batylne 57



Batylne 39



Batylne 40

# Roma

## BASE DE PARASOLES UMBRELLA BASE

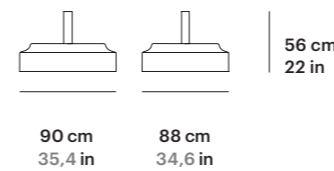

Peso Weight 33 Kg sin arena 72 lb without sand  
132 Kg con arena 291 lb with sand  
m<sup>3</sup> 0,16 m<sup>3</sup>

### Materiales y acabados Materials and finishes

Estructura Frame  
Aluminio lacado  
Lacquered aluminum

Patas Legs  
Pvc con ruedas  
Pvc with wheels



# City Long island

## Método de suspensión con lamas Slatted support system

Método de suspensión con lamas de polipropileno reforzadas con fibra de vidrio. Material 100% reciclado.

Estas dos colecciones, City & Long Island, cuentan con el método de lamas GOODSIDE. Se trata de un método de suspensión con lamas que se combinan con espuma. Las lamas se insertan entre dos capas de espuma cortada consiguiendo así mayor resistencia.

Se trata de un material absolutamente higiénico ya que no absorbe humedad y se puede limpiar con detergentes de limpieza normales sin dañar la superficie.

Los listones GOODSIDE resistentes a la intemperie permiten el uso en exteriores durante todo el año.

Los cojines con este sistema llevan siempre incluida la funda impermeable.

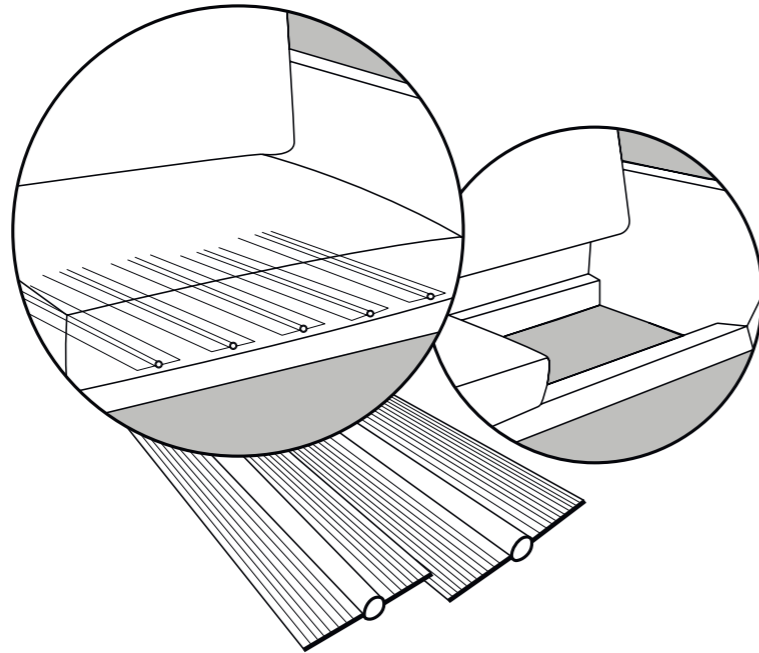

Method of suspension with fibreglass-reinforced polypropylene slats. 100% recycled material.

These two collections, City & Long Island, feature the GOODSIDE slat method. It is a suspension solution that uses slats combined with foam. The slats are inserted between two layers of cut foam for increased strength.

This is an absolutely hygienic material as it does not absorb moisture and can be cleaned with normal cleaning detergents without damaging the surface.

Weatherproof GOODSIDE slats can be used outdoors all year round.

With this system, the cushions always include a waterproof cover.

## GOODSIDE



# Composiciones Sugeridas Suggested Compositions

## Heritage

### Composición 1 Composition 1

Uds. Units	Ref.	Descripción Description
1	78542	Sofá 3 Mod. Brazo Derecho Right Arm Sectional Sofa 3
1	78551	Rinconera Corner
1	78546	Sofá 2 Mod. Brazo Izquierdo Left Arm Sectional Sofa 2
1	78553	Mesa Teca Centro Cuadrada Teak Square Coffee Table

### Composición 2 Composition 2

Uds. Units	Ref.	Descripción Description
4	78545	Sillón Lounge Chair
1	78544	Sofá 2 Mod. Brazo Derecho Right Arm Sectional Sofa 2
1	78546	Sofá 2 Mod. Brazo Izquierdo Left Arm Sectional Sofa 2
2	78553	Mesa Teca Centro Cuadrada Teak Square Coffee Table
2	78556	Mesa Teca Rincón Cuadrada Teak Square Side Table

### Composición 3 Composition 3

Uds. Units	Ref.	Descripción Description
1	78542	Sofá 3 Mod. Brazo Derecho Right Arm Sectional Sofa 3
1	78543	Sofá 3 Mod. Brazo Izquierdo Left Arm Sectional Sofa 3
2	78553	Mesa Teca Centro Cuadrada Teak Square Coffee Table



# Long Island

## Composición 1 Composition 1



Uds. Units	Ref.	Descripción Description
1	77840	Sofá 2 Modular Brazo Derecho Right Arm Sectional Sofa 2
1	77844	Rinconera Corner
1	77843	Sofá 3 Modular Brazo Izquierdo Left Arm Sectional Sofa 3
1	77853	Mesa Centro Cuadrada Tapa Porcelánico Square Coffee Table Porcelain Top

## Composición 2 Composition 2



Uds. Units	Ref.	Descripción Description
1	77840	Sofá 2 Modular Brazo Derecho Right Arm Sectional Sofa 2
2	77844	Rinconera Corner
1	77848	Sofá 3 Modular Sin Brazos Without Arms Sectional Sofa 3
1	77841	Sofá 2 Modular Brazo Izqdo. Left Arm Sectional Sofa 2
1	77853	Mesa Centro Cuadrada Tapa Porcelánico Square Coffee Table Porcelain Top

## Composición 3 Composition 3



Uds. Units	Ref.	Descripción Description
1	77842	Sofá 3 Modular Brazo Derecho Right Arm Sectional Sofa 3
1	77897	Chaise Longue Brazo Izquierdo Chaise Longue Left Arm
1	77854	Mesa Centro Rectangular Tapa Porcelánico Rectangular Coffee Table Porcelain Top

# Long Island

## Composición 4 Composition 4



Uds. Units	Ref.	Descripción Description
1	77840	Sofá 2 Modular Brazo Derecho Right Arm Sectional Sofa 2
1	77841	Sofá 2 Modular Brazo Izqdo. Left Arm Sectional Sofa 2
2	77853	Mesa Centro Cuadrada Tapa Porcelánico Square Coffee Table Porcelain Top

## Composición 5 Composition 5



Uds. Units	Ref.	Descripción Description
1	77843	Sofá 3 Modular Brazo Izquierdo Left Arm Sectional Sofa 3
1	77842	Sofá 3 Modular Brazo Derecho Right Arm Sectional Sofa 3
2	77853	Mesa Centro Cuadrada Tapa Porcelánico Square Coffee Table Porcelain Top

## Composición 6 Composition 6



Uds. Units	Ref.	Descripción Description
1	77843	Sofá 3 Modular Brazo Izq. Left Arm Sectional Sofa 3
1	77844	Rinconera Corner
1	77842	Sofá 3 Mod. Brazo Dcho. Right Arm Sectional Sofa 3
1	77853	Mesa Centro Cuadrada Tapa Porcelánico Square Coffee Table Porcelain Top

## Composición 7 Composition 7



Uds. Units	Ref.	Descripción Description
1	77897	Chaise Longue Brazo Izquierdo Chaise longue Left Arm
1	77896	Chaise Longue Brazo Derecho Chaise longue Right Arm



# Pal

## Composición 1 Composition 1



Uds. Units	Ref.	Descripción Description
1	7704504	Base 92 x 92 + Asiento Individual + Resp. Single + Brazo Dcho. Base 92 x 92 + Single Seat & Back + Right Arm
1	7704906	Base 246 x 92 + Asiento y Resp. Doble + Asiento y Resp. Single + Brazo Dcho. Base 246 x 92 + Double Seat & Back + Single Seat & Back + Right Arm
1	7704503	Base 92 x 92 + Asiento Individual + Resp. Single + Brazo Izq. Base 92 x 92 + Single Seat & Back + Left Arm
1	77051	Mesa tapa teca sin cristal Teak Top Table without Glass
1	77055	Mesa tapa teca sin cristal Teak Top Table without Glass
1	77056	Mesa tapa teca sin cristal Teak Top Table without Glass

## Composición 2 Composition 2



Uds. Units	Ref.	Descripción Description
1	7704708	Base 184 x 92 + Asiento Doble + Resp. Doble + Brazo Dcho. Base 184 x 92 + Double Seat & Back + Right Arm
1	7704501	Base 92 x 92 + Asiento Single + Resp. Single Dcho. Base 92 x 92 + Right Single & Back
1	77050	Mesa tapa teca sin cristal Teak Top Table without Glass

## Composición 3 Composition 3



Uds. Units	Ref.	Descripción Description
1	7704902	Base 246 x 92 + Asiento Doble + Resp. Doble Izq. Base 246 x 92 + Left Double Seat & Back
1	7704903	Base 246 x 92 + Asiento Doble + Resp. Doble + Brazo Dcho. Base 246 x 92 + Double Seat & Back + Right Arm
1	7704909	Base 246 x 92 + Asiento y Resp. Doble + Asiento Single + Brazo Izq. Base 246 x 92 + Double Seat and Back + Single Seat + Left Arm
1	7704701	Base 184 x 92 + Asiento Doble + Resp. Doble Dcha. Base 184 x 92 + Right Double Seat & Back
1	77053	Mesa tapa teca sin cristal Teak Top Table without Glass
1	77054	Mesa tapa teca sin cristal Teak Top Table without Glass

## Composición 4 Composition 4



Uds. Units	Ref.	Descripción Description
1	7704708	Base 184 x 92 + Asiento Doble + Resp. Doble + Brazo Dcho. Base 184 x 92 + Double Seat & Back + Right Arm
1	7704905	Base 246 x 92 + Asiento y Resp. Doble + Asiento y Resp. Single + Brazo Izq. Base 246 x 92 + Double Seat & Back + Single Seat & Back + Left Arm
1	77053	Mesa tapa teca sin cristal Teak Top Table without Glass

# Pal

## Composición 5 Composition 5



Uds. Units	Ref.	Descripción Description
1	7704907	Base 246 x 92 + Asiento y Resp. Doble + Asiento y Resp. Single Izq. Base 246 x 92 + Left Double Seat & Back + Single Seat & Back
1	7704904	Base 246x92 + Asiento Doble + Resp. Doble + Brazo Izq. Base 246 x 92 + Double Back + Left Arm
1	7704708	Base 184 x 92 + Asiento Doble + Resp. Doble + Brazo Dcho. Base 184 x 92 + Double Seat & Back + Right Arm
1	77055	Mesa tapa teca sin cristal Teak Top Table without Glass
2	77056	Mesa tapa teca sin cristal Teak Top Table without Glass

## Composición 6 Composition 6



Uds. Units	Ref.	Descripción Description
1	7704906	Base 246 x 92 + Asiento y Resp. Doble + Asiento y Resp. Single + Brazo Dcho. Base 246 x 92 + Double Seat & Back + Single Seat & Back + Right Arm
1	7704905	Base 246 x 92 + Asiento y Resp. Doble + Asiento y Resp. Single + Brazo Izq. Base 246 x 92 + Double Seat & Back + Single Seat & Back + Left Arm
1	77052	Mesa Tapa Teca sin Cristal Teak Top Table without Glass
2	77050	Mesa Tapa Teca sin Cristal Teak Top Table without Glass

## Composición 7 Composition 7



Uds. Units	Ref.	Descripción Description
3	7704500	Base 92 x 92 + Asiento Single + Resp. Single Base 92 x 92 + Single Seat & Back
1	7704504	Base 92 x 92 + Asiento Single + Resp. Single + Brazo Dcho. Base 92 x 92 + Single Seat & Back + Right Arm.
1	7704503	Base 92 x 92 + Asiento Single + Resp. Single + Brazo Izq. Base 92 x 92 + Single Seat & Back + Left Arm.

## Composición 8 Composition 8



Uds. Units	Ref.	Descripción Description
1	7704504	Base 92 x 92 + Asiento Single + Resp. Single + Brazo Dcho. Base 92 x 92 + Single Seat & Back + Right Arm.
2	7704500	Base 92 x 92 + Asiento Single + Resp. Single Base 92 x 92 + Single Seat & Back
1	7704400	Base 92 x 92 + Asiento Puf / Ottoman Seat



# FINISHES AND MAIN- TENANCE



**Shintotex®**  
Advanced synthetic fibres

Es la fibra sintética para muebles de exterior inspirada en la naturaleza y perfeccionada técnicamente hasta alcanzar el máximo nivel de confort, funcionalidad y durabilidad. El Shintotex está compuesto por PP y PE más componentes catalizadores como filtros UV, pigmentos, aditivos anti-estáticos y elementos plastificantes.

**Características Técnicas:**

Resistencia a cambios climatológicos.  
Resistencia a agentes químicos abrasivos.  
Resistencia a rotura y deterioro por el uso.  
Alta flexibilidad.  
Total reciclaje.

**Características Estéticas:**

Calidez y apariencia natural.  
Tacto agradable.  
Variedad de texturas y trenzados.  
Fácil limpieza.  
Mayor ligereza.

**Limpieza y mantenimiento**

Pasar cepillo de cerdas suaves sobre el tejido para eliminar el polvo o utilizar solución jabonosa de PH neutro para la limpieza de residuos o manchas. Evitar el contacto con productos abrasivos (lejías, cloro, aceites, productos con ácidos o sustancias corrosivas en su composición).



Round Ø6 mm Moss Brown

This is a synthetic fibre for outdoor furniture, inspired by nature and perfected by technology to achieve maximum comfort, functionality and durability. Shintotex is made of PP and PE, as well as catalysts, such as UV filters, pigments, additives, anti-static agents and plasticisers.

**Technical Features:**

Resistant to changing weather conditions.  
Resistant to abrasive chemical agents.  
Resistant to breakage and to wear and tear.  
Highly flexible.  
Fully recyclable.

**Aesthetic Features:**

Warm, natural appearance.  
Pleasant to the touch.  
Variety of textures and braids.  
Easy to clean.  
Lighter weight.

**Maintenance and cleaning**

Use a soft-bristled brush to remove any dust from the weave. Also, a soapy solution of neutral PH can be used to clean any residue or marks. Avoid contact with abrasive products (bleach, chlorine, oils, products containing corrosive acids or substances).



Round Ø6 mm Ash Grey



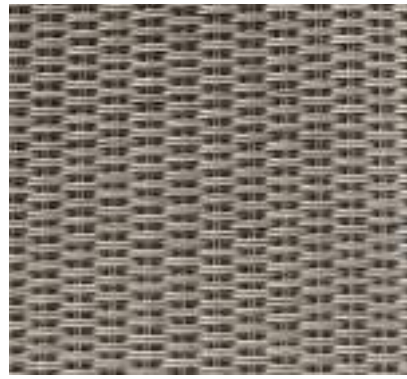

Round Ø3 mm Gris Plata / Silver Grey



Round Ø3 mm Blanco / White

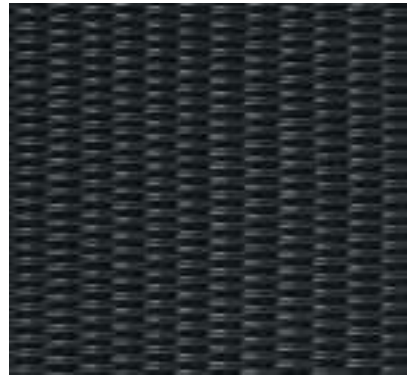

Round Ø3 mm Gris Oscuro / Dark Grey



Round Ø3 mm Marrón Castaño / Chestnut Brown



Round 3-4 mm 03 Tostado / Toasted

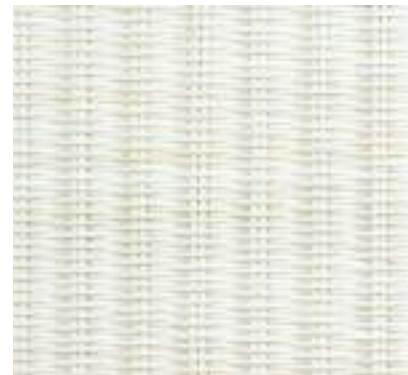

Round 3-4 mm 36 Marfil / Ivory

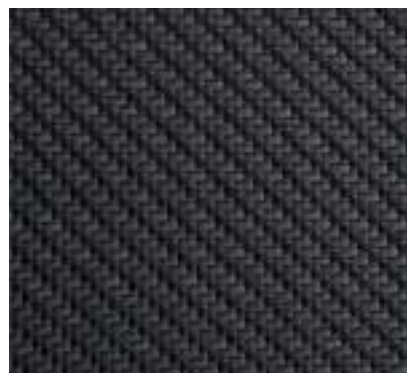

Flat oval 6mm 59 Dark



Flat oval 6mm 36 Marfil / Ivory



Flat oval 6mm 03 Tostado / Toasted

### Cuerda Rope Ø8 mm

Cuerda elaborada en hilo de poliéster, totalmente apta para exteriores. Ofrece gran resistencia a la luz (7 sobre 8) y a la intemperie.

Polyester rope for outdoor use. Offers great lightfastness (7 out of 8) and weather resistance.

#### Limpieza y mantenimiento

Utilizar solución jabonosa de PH neutro para la limpieza de residuos o manchas. Evitar el contacto con productos abrasivos (lejías, cloro, aceites, productos con ácidos o sustancias corrosivas en su composición).

#### Maintenance and cleaning

A soapy solution with a neutral pH can be used to clean residue or marks. Avoid contact with abrasive products (bleach, chlorine, oils, products containing corrosive acids or substances).

### Khai Collection



Turrón / Nougat



Taupe / Taupe



Negro / Black

### Weave Collection



61 Crema - Turrón / Cream - Nougat



60 Gris - Taupe / Grey - Taupe



59 Negro / Black



## Cuerda

### Rope

Ø4 mm

Summer Collection

City Collection

Tanto el ánima como el recubrimiento del cordón es de polipropileno para conseguir una mayor solidez a la luz e intemperie. Además, lleva un filtro de color para mayor fijación.

#### Limpieza y mantenimiento

Utilizar solución jabonosa de pH neutro para la limpieza de residuos o manchas. Evitar el contacto con productos abrasivos (lejías, cloro, aceites, productos con ácidos o sustancias corrosivas en su composición).

Both the rope itself and its coating are made from polypropylene to ensure greater resistance to light and weather. It also includes a colour filter for greater fixing.

#### Maintenance and cleaning

A soapy solution with a neutral pH can be used to clean any dirt or marks. Avoid contact with abrasive products (bleach, chlorine, oils, products containing acids or corrosive substances).



Beige / Beige



Gris Perlado / Pearl Grey



Grafito / Graphite





## Cuerda Sintética Synthetic Rope

Ø4 mm

Paralel Collection

Cuerda sintética para muebles de exterior compuesta de polietileno de alta densidad. Cuenta con un alto nivel de confort, funcionalidad y durabilidad.

### Características Técnicas:

Resistencia a cambios climatológicos.  
Resistencia a rotura y deterioro por el uso.  
Alta flexibilidad.  
Total reciclaje.

### Características Estéticas:

Calidez y apariencia natural.  
Tacto agradable.  
Fácil limpieza.  
Mayor ligereza.

### Limpieza y mantenimiento

Pasar cepillo de cerdas suaves sobre la cuerda para eliminar el polvo, o utilizar solución jabonosa de PH neutro para la limpieza de residuos o manchas. Evitar el contacto con productos abrasivos (lejías, cloro, aceites, productos con ácidos o sustancias corrosivas en su composición).

Synthetic rope for outdoor furniture. A high-density polyethylene compound that offers a high level of comfort, functionality and durability.

### Technical features:

Resistant to changing weather conditions.  
Resistant to breakage and to wear and tear.  
Highly flexible.  
Totally recycled.

### Aesthetic features:

Warm, natural appearance.  
Pleasant to the touch.  
Easy to clean.  
Lighter weight.

### Cleaning and maintenance

Brush the rope with a soft-bristled brush to remove any dust, or use a soapy solution with a neutral pH to clean any residue or marks. Avoid contact with abrasive products (bleach, chlorine, oils, products containing acids or corrosive substances).

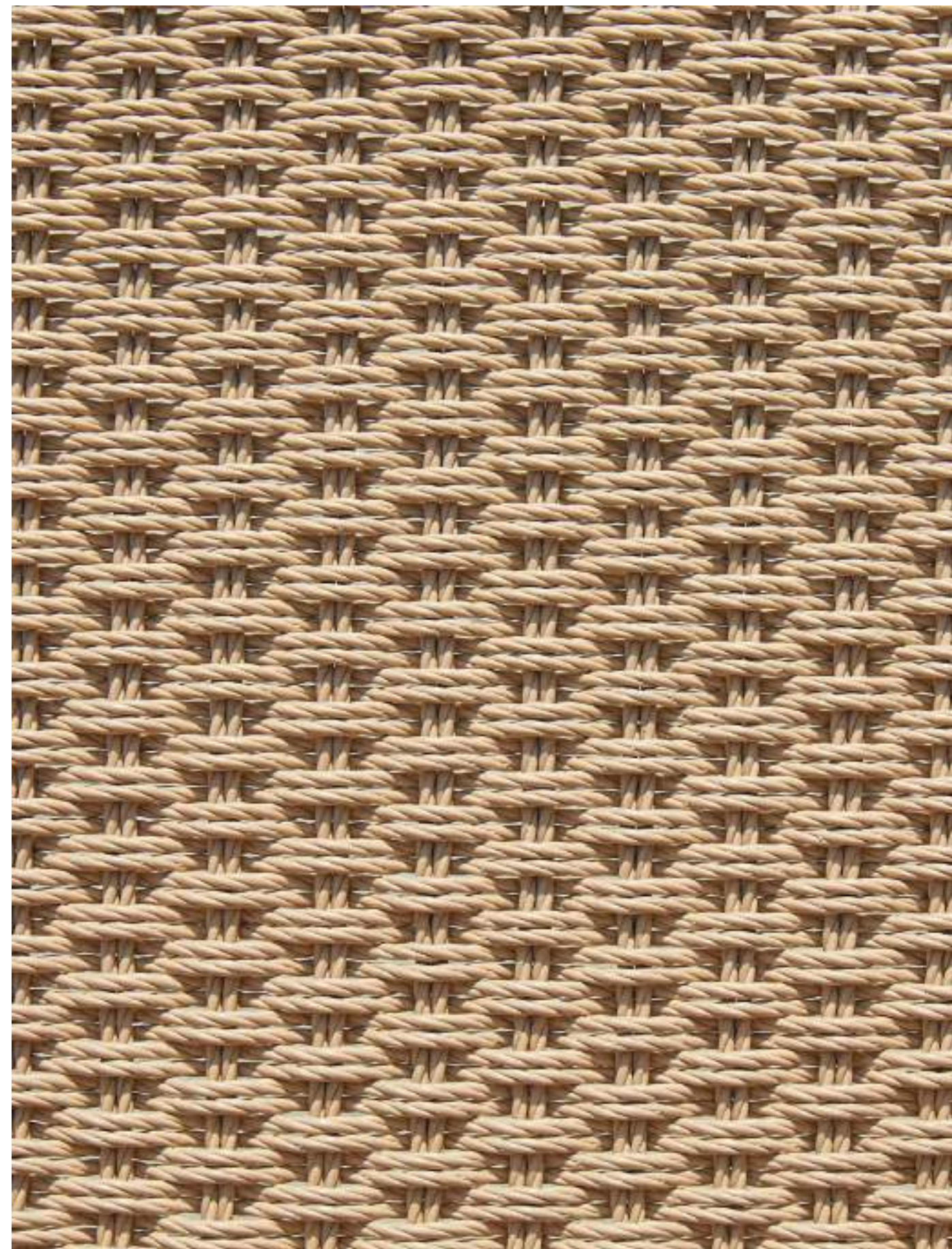





#### Madera de teca natural de grado A

POINT utiliza madera teca de grado A de origen asiático, procedente de bosques sostenibles de talas controladas. La teca está clasificada como la madera más premium del planeta y, por lo tanto, la más adecuada para los muebles de exterior.

Es extremadamente duradera, estable, impermeable y resistente a la intemperie. Esto se debe a los altos niveles de aceites naturales, dando como resultado una mínima absorción de la humedad y una gran estabilidad. Además, esta madera es muy resistente a los hongos, así como a los ataques de parásitos e insectos.

**POINT no aplica ningún “acabado” a nuestra teca. Toda nuestra teca tiene un acabado natural sin ningún tratamiento.**

Con el tiempo, los muebles de teca que están al sol, lluvia, humedad, etc. pueden volverse de un color gris plateado. Esto es debido a un proceso de oxidación superficial que protege naturalmente la madera y hace que adquiera una coloración gris plata. Este proceso es estético y no daña la resistencia ni la calidad de la madera.

Dependiendo de las condiciones ambientales, la coloración grisácea natural o el desgaste causado por factores climatológicos pueden notarse después de unas semanas. En climas más secos, la teca tardará varios meses en verse afectada.



Teca Natural / Natural Teak

#### Grade-A natural teak wood

POINT uses grade-A Asian teak wood sourced from carefully managed sustainable forests. Teak is considered the most premium wood on Earth and, therefore, the most suitable for outdoor furniture. It is extremely hard-wearing, stable, waterproof and weather-resistant. This is due to its high level of natural oils, resulting in minimal moisture absorption and great stability. This wood is also highly resistant to fungi and attacks by parasites and insects.

**At POINT we do not apply any “finish” to our teak. All our teak is untreated and has a natural finish.**

Over time, teak furniture that is exposed to sun, rain, humidity, etc. can turn a silver-grey colour. This is due to a process of surface oxidation that naturally protects the wood and gives it a silver-grey hue. This process is merely aesthetic and does not affect the strength or quality of the wood.

Depending on the environmental conditions, this natural greying or weathering may be noticed after a few weeks. In drier climates, it will take several months for the teak to be affected.

The appearance of oil on the surface of teak furniture is normal. It is the natural oils in teak that make it the best wood for outdoor furniture. In fact, a high oil content is an indicator of high-quality wood. Without

La aparición de aceite en la superficie de los muebles de teca es algo normal. Los aceites naturales presentes en la teca son los que la convierten en la mejor madera para muebles de exterior. De hecho, un alto contenido en aceite es un indicador de una madera de alta calidad. Sin estos aceites, la madera no sobreviviría a temperaturas y humedad extrema a la que normalmente están expuestos los muebles de exterior.

Los aceites y pigmentos dentro de la capa superficial de la teca comenzarán a lavarse gradualmente durante la exposición a las primeras lluvias. Este es un proceso natural y el aceite puede desprenderse durante los primeros 2 - 3 meses, según el entorno en el que se coloquen los muebles.

Evite colocar los muebles nuevos de teca en espacios exteriores con pavimentos de piedra porosa de color claro hasta que el proceso de expulsión de aceite haya disminuido. Del mismo modo, evite dejar cojines de colores claros sobre o cerca de los muebles de teca durante este proceso: los tejidos manchados con aceite de teca natural se pueden limpiar con agua y jabón neutro. La cantidad de aceite que sale de la teca durante los primeros meses será mayor y, por lo tanto, es más probable que cause manchas en las superficies y tejidos. Este es un proceso natural que no puede ser previsto.

Debido a que la teca es una madera naturalmente aceitosa, no es adecuado pintar ni barnizar. Cualquier pintura o barniz aplicada no se adherirá correctamente a la superficie y después de un tiempo comenzará a desprenderse. No recomendamos el uso de ningún aceite de madera en la teca. La teca ya es una madera naturalmente “aceitosa” y la adición de más aceite no agrega ninguna protección adicional. Si se incluye aceite de manera adicional, comenzará a crearse moho en las capas superficiales y la teca se volverá negra gradualmente; coloración que sólo puede eliminarse con un lijado agresivo.

these oils, the wood would not survive the extreme temperatures and humidity to which outdoor furniture is normally exposed.

The oils and pigments in the surface layer of the teak will gradually begin to wash away the first few times it is exposed to rain. This is a perfectly natural process and it can secrete oil for the first 2 - 3 months, depending on where the furniture is placed.

Do not place new teak furniture on light coloured porous stone patio surfaces until the oil secretion process has decreased somewhat. Similarly, avoid leaving cushions covered with light coloured fabrics on or near teak furniture during this process: fabric stained with natural teak oil can be cleaned with neutral soap and water. The amount of oil that comes out of the teak will be greater during the first few months and, therefore, it is more likely to stain surfaces and fabrics. This is a natural process that cannot be foreseen.

Wasps can occasionally attack the teak surface to make their nests, usually in the spring and early summer. There is no way to prevent this from happening, other than by removing their nests and scaring the wasps away.

#### Maintenance and cleaning

Despite being an excellent material for outdoor furniture, its treatment and maintenance are essential to preserve its beauty.

If you want to keep the natural silver colour, POINT recommends using the TEAK CLEANER to clean and polish the wood. To keep the teak looking like it did when it was new, first use the TEAK CLEANER to clean and polish and to restore the colour, then apply EcoSafe TEAK PROTECTOR to maintain and preserve its golden brown colour for longer. This is not an oil; it is a water-based,



## Limpieza y mantenimiento

A pesar de ser un excelente material para los muebles de exterior, su tratamiento y mantenimiento son indispensables para conservar su belleza.

Si usted quiere mantener el color plateado natural, POINT recomienda el uso del TEAK CLEANER para limpiar y abrillantar la madera. Para mantener la teca con el mismo aspecto que tiene cuando está recién sacada de la caja, use primero el limpiador y abrillantador TEAK CLEANER para restaurar el color y aplique, posteriormente, el protector TEAK PROTECTOR EcoSafe para mantener y conservar el marrón dorado durante más tiempo. Este producto no es un aceite y está elaborado a base de agua, sin disolventes. Ninguno de estos dos productos afecta a la resistencia y longevidad de los muebles, únicamente a su apariencia.



### Teak cleaner

#### Modo de empleo:

1. Antes de emplear el TEAK CLEANER, se debe utilizar una protección para los ojos y guantes de goma. Antes de empezar proteja la superficie en donde se va a trabajar.
2. Primero mojar el mueble con agua.
3. Agite el TEAK CLEANER antes de usar.
4. Aplique el TEAK CLEANER con un paño suave o una esponja. Dejar penetrar durante 3 minutos.
5. Cepille el mueble para limpiarlo con una almohadilla de fregar en dirección al veteado.
6. Lave bien el mueble con agua.
7. Para un color prolongado, deje secar el mueble y trátelo con TEAK PROTECTOR.

solvent-free product. Neither of the two products affects the strength and longevity of the furniture, only its appearance.

Because teak is a naturally oily wood, it should not be painted or varnished. Any paint or varnish applied will not adhere properly to the surface and will soon begin to peel. We do not recommend using any wood oil on teak. Teak is already a naturally "oily" wood and the addition of more oil does not confer any additional protection. If oil is added, mould will begin to build up in the surface layers and the teak will gradually turn black, which can only be removed by aggressive sanding.

### Teak cleaner

#### Directions for use:

1. Before using the TEAK CLEANER, put on eye protection and rubber gloves. Before you start, protect the surface where you are going to work.
2. First wet the furniture with water.
3. Shake the TEAK CLEANER before use.
4. Apply the TEAK CLEANER with a soft cloth or a sponge. Allow to penetrate for 3 minutes.
5. Use a scouring pad to clean the furniture, brushing it in the direction of the wood's grain.
6. Wash the furniture thoroughly with water.
7. For long-lasting colour, let the furniture dry and treat it with the TEAK PROTECTOR.



### Teak protector

#### ¿Por qué es mucho mejor que el TEAK SELLADOR?

1. Mantiene el color marrón dorado de la teca durante más tiempo:
  - Hasta 4 veces más que el aceite de teca.
  - Hasta el doble de largo que los selladores de teca.
2. Es respetuoso con el medio ambiente porque es 100% con base de agua. Sin humos tóxicos. No es inflamable. EcoSafe.
3. Es rápido y fácil de aplicar.
4. No es un aceite, no es grasiento.
5. Es resistente al moho y evita manchas negras en la teca.

#### Instrucciones de uso:

1. Antes de utilizar el TEAK PROTECTOR se debe utilizar protección en los ojos y guantes de goma. Cubra el suelo debajo de su área de trabajo antes de comenzar.
2. La teca gris o la teca tratada con aceite de teca deben limpiarse primero con TEAK CLEANER.
3. Teca nueva: limpie con TEAK CLEANER para eliminar algunos de los aceites naturales de la teca o también puede dejar a la intemperie durante 2 semanas en el exterior antes del tratamiento.
4. Si la madera limpia está áspera, lijar ligeramente antes de tratar con TEAK PROTECTOR. Asegúrese de que la teca esté 100% seca y sin de polvo.
5. Agitar y remover el TEAK PROTECTOR al menos un minuto antes de usar. Una agitación insuficiente puede provocar un desgaste desigual.
6. Le sugerimos que pruebe el TEAK PROTECTOR en un área pequeña primero (por ejemplo, en la parte posterior de una pata del mueble) para juzgar si el color cumple con sus expectativas.
7. Aplicar una capa muy fina de TEAK PROTECTOR uniformemente sobre el mueble con un paño sin polvo. Aplicar una segunda capa muy fina después de 30 minutos de secado.
8. Se recomienda tratar sus muebles con TEAK PROTECTOR al menos una vez al año.

### Teak protector

#### Why is it so much better than TEAK OIL SEALER:

1. It maintains the light-brown colour of teak for a longer time:
  - Up to 4 times longer than teak oil.
  - Up to twice as long as teak sealers.
2. It is environment-friendly because it is 100% water-based; no toxic fumes; non flammable; EcoSafe.
3. It is fast and easy to apply.
4. It is not an oil, it is not greasy: clothes stay clean.
5. It is resistant to mould and prevents black spots on the teak.

#### Instructions for use:

1. Before using the TEAK PROTECTOR, put on eye protection and rubber gloves. Before you start, protect the surface where you are going to work.
2. Grey teak or teak treated with teak oil must first be cleaned with TEAK CLEANER.
3. In the case of new teak, first clean it with our TEAK CLEANER to remove some of the natural teak oils (or weather for 2 weeks outside before treatment).
4. If cleaned wood feels rough, sand it lightly before treating it with the Protector. Make sure the teak is completely dry and free from dust.
5. Shake and stir the TEAK PROTECTOR for at least a minute before use. Insufficient shaking can lead to uneven weathering.
6. We suggest you try the TEAK PROTECTOR on a small area first (e.g. the back of a leg) to ensure that the colour meets your expectations.
7. Apply a very thin layer of TEAK PROTECTOR evenly over the furniture with a dust-free cloth. Apply a second very thin coat after leaving to dry for 30 minutes.
8. We recommend that you treat your furniture with TEAK PROTECTOR at least once a year.



## Teca Weathered Weathered Teak

### La sabiduría de la edad

POINT ofrece dos tipos de acabado en sus maderas de teca, uno sin tratamiento, totalmente natural en el que el material envejece adquiriendo una hermosa pátina gris. Y, otro –weathered– en el que la madera se somete a un proceso sostenible de envejecimiento, que consiste en erosionar la veta de la madera cepillándola repetidas veces totalmente a mano hasta conseguir una textura más rústica de la veta y se le aplica un tratado con base al agua ecológico que consigue este característico efecto envejecido que adquiere la teca a la intemperie.

Este tratamiento de madera envejecida, se va desprendiendo con la exposición a los elementos. Así, la teca natural va quedando expuesta y tomando la tonalidad gris característica. El ritmo de envejecimiento del acabado varía en función del clima, la exposición y la dedicación al cuidado y mantenimiento. El proceso de envejecimiento se puede acelerar, voluntariamente, con solo dejar los muebles sin tratar o sin cubrir.



Teca Weathered / Weathered Teak

### The wisdom of age

POINT offers two types of finish on its teak woods. One is untreated and completely natural, where the material takes on a beautiful grey patina as it ages. The other is weathered, where the wood undergoes a sustainable ageing process that consists of eroding the grain of the wood by repeatedly brushing it by hand to give the grain a more rustic texture. Then an ecological water-based treatment is applied to achieve this characteristic weathered look that teak takes on when exposed to the elements.

This weathered wood treatment gradually fades with exposure to the elements, leaving the natural teak exposed so that it takes on the characteristic grey tone. The rate at which the finish ages varies according to climate, exposure, and care and maintenance. The ageing process can be accelerated voluntarily by simply leaving the furniture untreated or uncovered.





## Porcelánico Porcelain

Se trata de un material porcelánico elaborado de 12 mm de espesor. Características técnicas: Impermeable y resistente a líquidos, con un nivel de absorción próximo a cero. Resistente al rayado y a la abrasión gracias a la dureza de su superficie. No se quema en contacto con el fuego ni emite humo ni sustancias tóxicas al ser sometido a altas temperaturas. Resistente a cualquier tipo de agente químico de limpieza. No desprende sustancias nocivas. Es totalmente apto para el contacto con los alimentos. Certificado NSF. Siendo 100% natural, los colores no se desvirtúan cuando el material se expone al sol o a condiciones meteorológicas extremas. No desprende ninguna sustancia nociva para el entorno. Hasta un 52% de material reciclado en cada tabla. 100% reciclable. 30 kg/m<sup>2</sup> en la tabla de 12 mm. Módulo de rotura elevado. Resistente a altas cargas de presión y peso.

This is a 12-mm thick porcelain material. Technical characteristics: Waterproof and resistant to liquids, with an absorption level close to zero. Scratch and abrasion resistant thanks to the hardness of the surface. No combustion takes place in contact with fire and no smoke or toxic substances are released when it is subjected to high temperatures. Resistant to any type of chemical or cleaning agent. No dangerous substances are given off. It is totally apt for contact with foodstuffs. NSF certified. As it is 100% natural, the colours do not fade when exposed to sunlight or subjected to extreme weather conditions. No dangerous substances that may harm the environment are given off. Each board contains up to 52% recycled material. 100% recyclable. 30 kg/m<sup>2</sup> in a 12 mm board. Highly resistant to breakage. Resistant to high pressures and loads.

### Limpieza y mantenimiento

Tiene una limpieza fácil ya que no pueden penetrar en el material los restos de comida y residuos que se depositen por lo que garantizan una buena higiene. Para la mayoría de los casos, sólo bastará con un paño húmedo para limpiarlo. Use un paño de microfibra para quitar el polvo de la superficie. Se puede lavar con agua tibia, a la cual se le puede agregar un detergente en la dosis de uso recomendado por el fabricante. (Deben evitarse productos que contengan ácido fluorhídrico y sus derivados). Enjuagar con agua tibia y secar con bayetas o algo similar.

### Maintenance and cleaning

Easy to clean, as traces of food and other residues on the surface cannot penetrate the material, thus offering enhanced hygiene; in most cases, it is sufficient to wipe the surface clean with a damp cloth. Use a microfibre cloth to dust the surface. To wash, use lukewarm water; a detergent may be added according to the dosage recommended by the manufacturer (products containing hydrofluoric acid and its derivatives should be avoided). Rinse with lukewarm water and dry with a clean cloth.



87 Gris Ocre / Ochre Grey



85 Blanco Roto Veteado / Veined Off White



82 Gris Lava / Lava Grey



86 Gris Basalto / Basalt Grey



81 Blanco Natural / Natural White



## Compacto HPL

Es el material de las tapas de las mesas de algunas colecciones. Se trata de tablero compacto de 10 mm de espesor en calidad standard (CGS) termoendurecido a alta presión en formato 4200x1600 mm con el núcleo compuesto de resinas fenólicas y superficies decorativas impregnadas en resinas melamínicas.

### Limpieza y mantenimiento

Las superficies de compacto deben limpiarse con regularidad pero no requieren ningún mantenimiento especial, solo un paño húmedo con agua templada o detergente suave. Se pueden usar perfectamente casi todos los productos de limpieza o desinfectantes domésticos siempre y cuando estos no sean abrasivos o altamente alcalinos.

This is the material used for the table tops of some collections. It is a 10-mm thick, compact board in standard quality (CGS), which was thermoset at high pressure in a 4200x1600 mm mould, with a core made of phenolic resins and decorative surfaces that are impregnated with melamine resins.

### Maintenance and cleaning

Surfaces made out of HPL should be cleaned regularly and do not require any special maintenance; just wipe with a damp cloth that has been previously soaked in lukewarm water with a gentle detergent. Almost all kinds of cleaning products can be used without any problem, as long as they are not abrasive or highly alkaline.



Beige / Beige



Negro / Black



Blanco Monocolor / Solid White



Blanco Marmolizado / Marbled White



Madera / Wood



Taupe Monocolor / Solid Taupe



## Aluminio pintado en polvo Powder coated aluminium

Con resina epóxica como ligante, para incrementar la resistencia a la corrosión, abrasión y a los agentes químicos.

### Limpieza y mantenimiento

Utilizaremos bayetas suaves o esponjas que no rayen la superficie y agua con jabón o detergentes neutros diluidos en agua; nunca productos abrasivos. Después se enjuagará con agua limpia y se secará con un paño, para evitar que el detergente afecte al material.

With epoxy resin used as a binder to increase resistance to corrosion, abrasion and chemical agents.

### Maintenance and cleaning

Use soft cloths or sponges that will not scratch the surface with soap and water or neutral detergents diluted in water; never use abrasive products. Then rinse with clean water and dry with a cloth to prevent the detergent from affecting the material.



73 Verde Ficus / Green Ficus



34 Crema / Cream



70 Blanco Nieve / White Snow



56 Gris Metalizado / Gunmetal Grey



59 Negro / Black



72 Terracota / Terracotta



71 Azul Cielo / Blue Sky



60 Gris Taupe / Taupe Grey



75 Óxido / Rust



74 Arena / Sand

## Funda de cubrir

En POINT recomendamos proteger los muebles de exterior con medidas simples y mejorar así su durabilidad. Para ello, creamos la Protective Cover, una funda protectora especial, disponible en color beige, hecha de poliéster con lacado acrílico. Es resistente al agua y cuenta con un tratamiento fungicida en el interior. Además, es repelente a la suciedad y resistente al frío, al calor y a la intemperie. Cada pieza cuenta con su propia funda. Además, tiene un cordón que permite ajustar la funda al mueble, alrededor de la base, para que el viento no pueda levantarla. Para obtener mejores resultados, es conveniente que los muebles, cojines y cuadrantes estén secos antes de cubrirlos para evitar humedad y manchas de moho.

## Protective cover

At POINT we recommend simple measures to protect outdoor furniture and make it more durable. For this purpose, we created the Protective Cover, a special protective sheet, available in beige and made from polyester with acrylic lacquer. It is waterproof and treated with a fungicide on the inside. It also repels dirt and is heat, cold and weather resistant. Each piece comes with its own cover. It also includes a tie so you can adjust the cover to the furniture around the base to secure it against the wind. For the best results, the furniture and cushions should be dry before they are covered in order to avoid moisture and mould stains.





# FABRICS



**Composición:** 100% Acrílico teñido en masa  
**Ancho:** 160cm  
**Acabado:** hidrófugo con tratamiento antimanchas.  
**Solidez a la luz:** 7/8  
**Garantía:** 5 años  
**Tolerancia:** valores susceptibles de tolerancia de +/- 5%

**Composition:** 100% solution dyed acrylic  
**Width:** 160 cm  
**Finish:** water repellent with a stain resistant treatment.  
**Light fastness:** 7/8  
**Warranty:** 5 years  
**Tolerance:** values subject to +/- 5% tolerance

**Limpieza y mantenimiento**  
**Maintenance and cleaning**

Eliminar la suciedad mediante cepillado o aspirado suave del tejido. Lavar a temperatura máxima de 30º y jabón neutro. No utilizar disolventes ni detergentes abrasivos. No utilizar secadora. Planchado máximo a 150º. No admite lavado en seco.

Remove dirt by softly brushing or vacuuming the fabric. Wash at 30º max. with a mild soap. Do not use solvents or abrasive detergents. Do not tumble dry. Iron up to 150º max. Do not dry clean.



Resistente al agua  
Water resistant



Resistente a las manchas  
Stain resistant



Resistente al moho  
Mould resistant



Fuerte y duradero  
Durable and strong



Aislante  
Non-conductive



Fácil de limpiar  
Easy to clean



Protección UV  
UV protection



Desinfectable  
Disinfectable



Resistente a los rayos UV  
UV resistant



Limpiable con lejía  
Bleach cleanable

**Composición:** Composite PVC – fibras sintéticas  
**Ancho:** 180cm  
**Garantía:** 5 años  
**Reciclabilidad:** 100% por el sistema Texyloop  
**Sistema de gestión de calidad:** ISO 9001  
**Sistema de gestión medioambiental:** ISO 14001

**Composition:** Composite PVC-synthetic fibres  
**Width:** 180 cm  
**Warranty:** 5 years  
**Recyclability:** 100% by Texyloop method  
**Quality system:** ISO 9001  
**Environmental system:** ISO 14001

**Limpieza y mantenimiento**  
**Maintenance and cleaning**

Quitar el polvo al tejido con un aspirador o un cepillo suave no metálico. Lavar con un cepillo suave o una esponja utilizando agua jabonosa. Aclarar abundantemente con agua clara (chorro de agua). Dejar que se seque bien el tejido al aire libre en posición desplegada. Si el tejido puede desprenderse de su soporte, la limpieza puede realizarse a máquina a una temperatura no superior a 40°C.

Remove dust from the fabric with a vacuum cleaner or soft, non-metallic brush. Wash with a soft brush or a sponge, using soapy water. Rinse copiously (spray) with clean water. Allow the fabric to air dry completely, well spread out. If the textile can be removed from its base, it may be machine-washed at a temperature no higher than 40°C.



Fácil cuidado  
Easy care



Resistente al desgarro  
Tear resistant



Resistente a los rayos UV  
UV resistant



Resistente al moho  
Mould resistant



Resistente a la deformación  
Deformation resistance



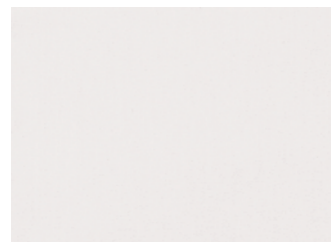

G1 22 20000 C. Martindale



G1 21 20000 C. Martindale



G1 1101 20000 C. Martindale

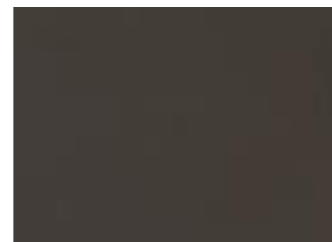

G1 1103 20000 C. Martindale



G1 1119 20000 C. Martindale



G1 1201 20000 C. Martindale



G2 1086 25000 C. Martindale

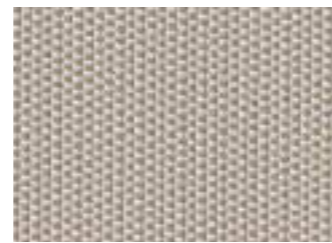

G2 1088 20000 C. Martindale



G2 1269 20000 C. Martindale



G2 1253 20000 C. Martindale



G2 1255 20000 C. Martindale



G2 1252 25000 C. Martindale



G2 1256 20000 C. Martindale



G2 1270 20000 C. Martindale



G2 1271 20000 C. Martindale



G2 1273 20000 C. Martindale



G2 1272 20000 C. Martindale



G2 1275 20000 C. Martindale

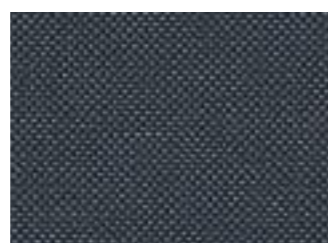

G2 1268 20000 C. Martindale



G2 1263 20000 C. Martindale

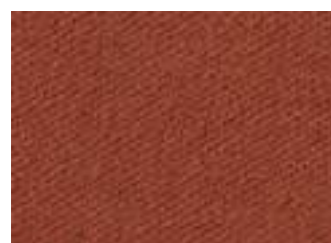

G2 1274 20000 C. Martindale



G3 1276 60000 C. Martindale



G3 1277 60000 C. Martindale



G3 1278 60000 C. Martindale



G3 1279 60000 C. Martindale



G3 1280 60000 C. Martindale

### BATYLINE



G3 13 120000 C. Martindale



G3 09 120000 C. Martindale



G3 10 120000 C. Martindale



G3 11 120000 C. Martindale



G2 35 120000 C. Martindale

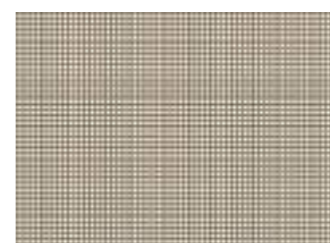

G2 37 120000 C. Martindale



G2 39 120000 C. Martindale



G2 40 120000 C. Martindale

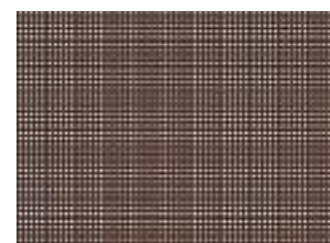

G2 38 120000 C. Martindale



G2 57 120000 C. Martindale



**Art direction & layout**

Ibán Ramón

**Photography**

Ángel Segura

**Photography art direction**

PerezOchando & POINT

**Texts**

Cano Estudio

**Printing**

Pentagraf Impresores

**POINT, S.L.**

Partida Planet, s/n.  
03727 Jalón (Alicante) Spain

T. +34 966 480 132

Fax +34 966 480 358

info@point1920.com

www.point1920.com