



Colección modular soft seating de formas sinuosas y generosas dimensiones, con infinidad de opciones en sus modelos. Este diseño modular permite la combinación de su piezas para crear distintas combinaciones para cada tipo de espacio, es por ello que es ideal para decorar y dar un aspecto atractivo a espacios multifuncionales en todo tipo de entornos: lobbies, zonas de espera y contract, áreas comunes, oficinas...

Del diálogo entre la precisión de la geometría y la libertad de la experimentación nace esta colección con un discurso contemporáneo y abierto a un sinfín de posibles composiciones diseñadas para vestir espaciosos ambientes que marcan un estilo de vida.

Estas piezas modulares con el tapizado como protagonista, posibilitan tanto las bancadas de asientos curvos como de dos o tres plazas, tanto con brazos y respaldos como sin ellos, y las butacas y pufs de una plaza. Su estructura metálica de cuatro patas pintada en cualquiera de los colores de muestrario posibilita la customización de cada proyecto.

Modular soft seating collection with sinuous shapes and generous dimensions, with an infinite number of options in its models. This modular design allows the combination of its pieces to create different combinations for each type of space, which is why it is ideal for decorating and giving an attractive appearance to multifunctional spaces in all types of environments: lobbies, waiting and contract areas, common areas, offices...

From the dialogue between the precision of geometry and the freedom of experimentation is born this collection with a contemporary discourse open to an endless number of possible compositions designed to dress spacious environments that mark a lifestyle.

These modular pieces, with upholstery as the protagonist, make possible both curved and two- or three-seater benches, with or without armrests and backrests, and one-seater armchairs and poufs. Its four-legged metal structure, painted in any of the sample colors, makes it possible to customize each project.

Sofá 1 plaza / 1 seat sofa

Dimensiones y peso / Dimensions and weight

TRS1P2

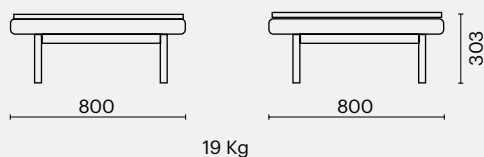

TRS1P0

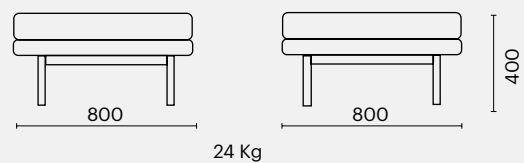

W Anchura / Width; H Altura / Height; D Profundidad / Depth; S Altura hasta asiento / Height up to seat.

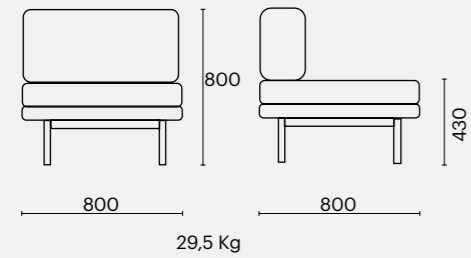
TRS1P1**Sofá 2 plazas / 2 seat sofa**

Dimensiones y peso / Dimensions and weight

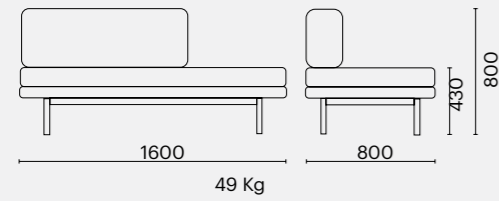
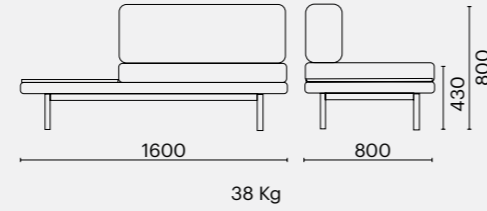
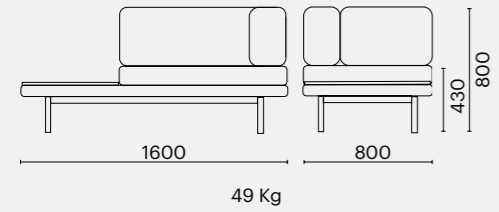
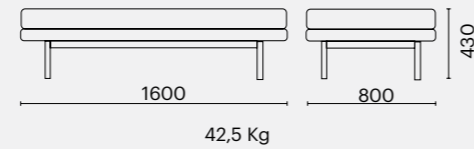
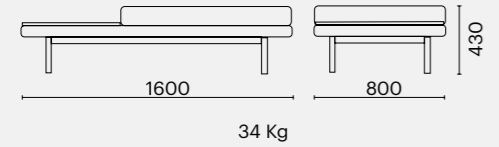
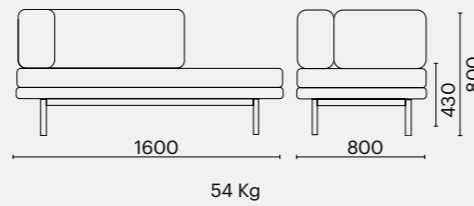
TRS2P1R / TRS2P1L**TRS2P12L / TRS2P12R****TRS2P12BL / TRS2P12BR****TRS2P0****TRS2P02****TRS2P1BL / TRS2P1BR****Sofá 3 plazas / 3 seat sofa**

Dimensiones y peso / Dimensions and weight

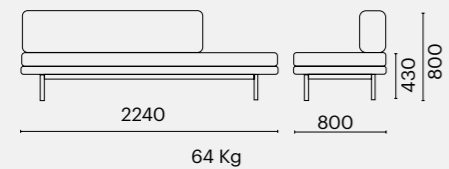
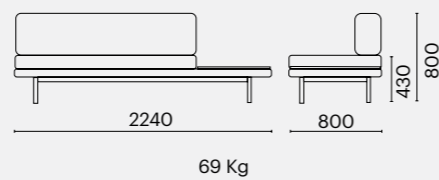
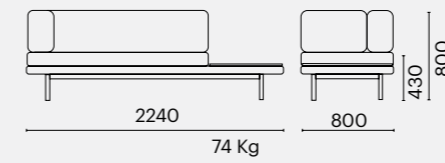
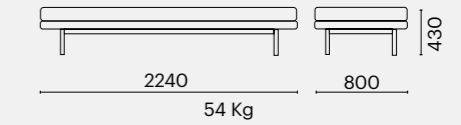
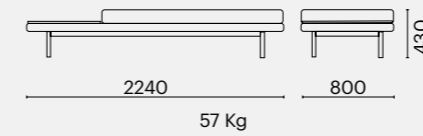
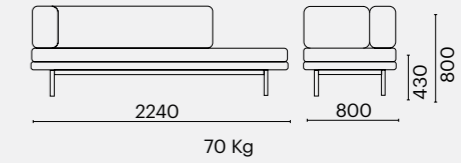
TRS3P1L / TRS3P1R**TRS3P12L / TRS3P12R****TRS3P12BL / TRS3P12BR****TRS3P0****TRS3P02****TRS3P1BR / TRS3P1BL****Sofá curvo / Curved sofa**

Dimensiones y peso / Dimensions and weight

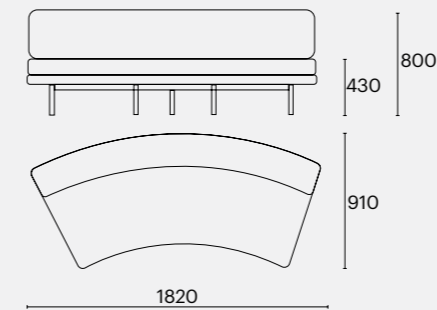
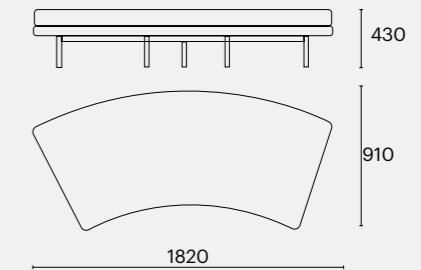
TRC2P1**TRC2P0****ASIENTO Y RESPALDO / SEAT AND BACKREST**

Base con canto regresado de 40mm fabricado en contrachapado. La estructura interior del asiento se fabrica en aglomerado de 10mm para aportarle solidez. Revestido con espuma flexible de PU de 120mm de espesor. Ambas piezas van tapizadas de forma independiente y unidas entre si. Los respaldos y los brazos se realizan en aglomerado de 10mm y tubos metálicos de fijación que quedan ocultos gracias a la espuma de 220mm tapizada. Tanto asiento como respaldo y brazos van recubiertos con manta de fibra.

Base with thickened edge of 40mm made of plywood, to lighten its weight. The inner structure of the seat is made of 10mm chipboard to provide strength. Covered with 120mm PU flexible foam. Both pieces are independently upholstered and joined together. The backrest and armrests are made of 10mm chipboard and metal fixing tubes that are hidden thanks to the 220mm upholstered foam. Seat, backrest and armrests are covered with fiber blanket.

Estos sofás modulares se presentan en formato individual, doble, triple o curvo para aportar funcionalidad a cualquier composición. Además permiten la incorporación de mesa que puede combinar con los asientos maximizando su funcionalidad.

These modular sofas are available in single, double, triple or curved format to provide functionality to any composition. They also allow the incorporation of a table that can be combined with the seats maximizing its functionality.

TAPAS DE MESA / TABLE TOPS

En el modelo de una plaza las dimensiones son de 790x790mm y en el dos y tres plazas son de 650x790mm. Los acabados ofrecidos son contrachapado de 13mm canto barnizado, cubierto por estratificado roble claro, roble oscuro, antracita antihuellas y negro infinity antihuellas.

In the one-seater model the dimensions are 790x790mm and in the two and three-seater models they are 650x790mm. The finishes offered are 13mm plywood with varnished edge, covered by stratified light oak, dark oak, anthracite anti-fingerprint and black infinity anti-fingerprint.

ESTRUCTURAS METÁLICAS / METALLIC STRUCTURES

La base en bancada está formada dos largueros y dos travesaños de 60x20mm y cuatro patas fabricadas en tubo de acero de Ø26mm pintadas con pintura epoxi en los colores de nuestro muestrario. La estructura se une a la base del sofá mediante dos chapas plegadas soldadas a los travesaños.

The base is made up of two 60x20mm beams and two 60x20mm crossbeams and four legs made of Ø26 steel tube painted with epoxy paint in the colors of our sample book. The structure is joined to the base of the sofa by means of two folded sheets welded to the crossbeams.

ACABADOS DE LAS ESTRUCTURAS METÁLICAS / METALLIC STRUCTURES FINISHES

ESTÁNDAR / STANDARD



RAL 9005 Negro (N) Black



RAL 9016 Blanco (B) White

COLORES (liso semibrillo) / COLORS (Semi-gloss smooth)

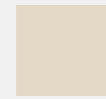

RAL 1013 Oyster White (OW)



RAL 1019 Visón (VI) Mink



RAL 1032 Mostaza (MO) Mustard



RAL 3003 Rojo (RO) Red



RAL 5014 Celeste (CE) Light Blue



RAL 5020 Verde Oceano (VO) Ocean Green



RAL 7004 Gris (GR) Grey



RAL 6013 Verde Light Green

COLORES (Texturado) / COLORS (Textured)

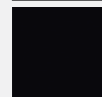

RAL 5011 Blue Night (BN)



RAL 6005 Moss Green (MG)



RAL 7016 Anthracite (AN)

COLORES (Liso semimate) / COLORS (Semi-mate Smooth)



NCS 3020 Y80R Powder (PO)

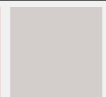

NCS 1502-B Light Grey (LG)



RAL 8004 Terracota



RAL3009 Oxide Red

Metalizados / Metallized

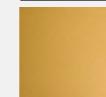

Gold (smooth)

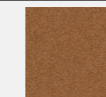

Copper (Textured)

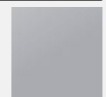

Silver (smooth) RAL 9006

ACABADOS DE TAPAS DE MESAS / TABLE TOP FINISHES



Negro / Black

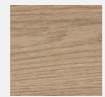

Roble Claro / Light Oak



Antracita / Anthracite

TAPICERÍA / UPHOLSTERY

La colección Track puede ser tapizados en cualquiera de los tejidos incluidos en el muestrario Mobboli, incluso en tapicerías adecuadas aportadas por el cliente.

The Track collection can be upholstered in any of the fabrics included in the Mobboli sample, even in suitable tapestries provided by the customer.

COLECCIÓN / COLLECTION



TRS1P2

Mesa
Table



TRS1PO

Módulo puf 1 plaza
1 seat pouf module



TRS1P1

Módulo de una plaza con respaldo
1 seat module with backrest



TRS2PO

Módulo puf de 2 plazas
2 seat pouf module



TRS2PO2

Módulo puf 2 plazas con mesa
2 seat pouf module with table



TRS2P12BL / TRS2P12BR

Módulo puf 2 plazas con mesa, respaldo y brazo
2 seat pouf module with table, backrest and armrest



TRS2P1R/TRS2P1L

Módulo de 2 plazas con respaldo
2 seat pouf module with backrest



TRS2P12R/TRS2P12L

Módulo de 2 plazas con respaldo y mesa
2 seat pouf module with backrest and table



TRS2P1BL / TRS2P1BR

Módulo puf 2 plazas con respaldo y brazo
2 seat pouf module with backrest and armrest



TRS3PO

Módulo puf de 3 plazas
3 seat pouf module



TRS3PO2

Módulo puf 3 plazas con mesa
3 seat pouf module with table



TRS3P12BL / TRS3P12BR

Módulo de 3 plazas con respaldo, mesa y brazo
3 seat pouf module with backrest, armrest and table



TRS3P1R/TRS3P1L

Módulo de 3 plazas con respaldo
3 seat pouf module with backrest



TRS3P12R/TRS3P12L

Módulo de 3 plazas con respaldo y mesa
3 seat pouf module with backrest and table



TRS3P1BR / TRS3P1BL

Módulo de 3 plazas con respaldo y brazo
3 seat pouf module with backrest and armrest

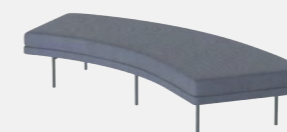

TRC2PO

Módulo puf 2 plazas curvo
2 seat curved module pouf



TRC2P1

Módulo 2 plazas curvo con respaldo
2 seat curved module with backrest



TRC

Cojín tacto blando
Soft touch cushion
500x450x150mm

OPCIONES / OPTIONS

Los módulos de 2 y 3 plazas ofrecen modelos con brazos laterales incorporados (ver en modelo), brazo derecho o izquierdo que comparte la misma altura y ancho que el respaldo, como continuidad al mismo.
La colección dispone de cojines tapizados cuadrados de gran formato como accesorio que debe pedirse por separado en el mismo tapizado que el sofá u en otro.

The 2 and 3-seater modules offer models with built-in side arms (see model), right or left arm that share the same height and width as the backrest, as a continuity to the backrest.
The collection has large square upholstered cushions as an accessory that must be ordered separately in the same upholstery as the sofa or in another one.

DISEÑADOR / DESIGNER



Francesc Rifé

Interiorista y diseñador industrial, funda su estudio en Barcelona en 1994. Influenciado por el minimalismo, y marcado por una historia familiar ligada a la artesanía, articula toda su obra en torno al orden espacial y a la proporción geométrica. Durante su trayectoria ha obtenido varios premios de diseño como los Contract World Awards, el Red Dot, ICFF Editors Awards, el HIP Award en Chicago, los Premios FAD y varios premios ASCER.

Interior and industrial designer, he founded his studio in Barcelona in 1994. Influenced by minimalism, and marked by a family history linked to craftsmanship, he articulates all his work around spatial order and geometric proportion. During his career he has won several design awards such as the Contract World Awards, the Red Dot, ICFF Editors Awards, the HIP Award in Chicago, the FAD Awards and several ASCER awards.

NORMATIVAS Y CERTIFICADOS / REGULATIONS AND CERTIFICATES

Proceso de fabricación bajo certificado de gestión de calidad UNE EN ISO 9001:2015, medioambiente UNE EN ISO 14001:2015.
· Ficha de reciclabilidad que contempla el estudio de los menores impactos medioambientales del producto a lo largo de su ciclo de vida.

Manufacturing process under quality management certificate UNE EN ISO 9001: 2015, environment UNE EN ISO 14001: 2015.
· Recyclability sheet that includes the study of minors environmental impacts of the product throughout its cycle of life.



GARANTÍA / WARRANTY

Mobboli ofrece una garantía de 5 años contra todo defecto de fabricación sin incluir los daños ocasionados por un uso inadecuado ni los propios del desgaste por uso o accidente. Quedan excluidos también de la garantía los daños ocasionados por un mantenimiento o limpieza inadecuada. Quedan excluidas de la garantía las roturas y manchas de tapicería. Deberá acreditar la fecha de compra del producto con la factura correspondiente y con fotografía del Nº etiqueta calidad.

Mobboli offers a 5-year warranty against manufacturing defects, not including damage caused by improper use or damage caused by wear or accident. Damages caused by improper maintenance or cleaning are also excluded from the warranty. Breaks and stains of upholstery are excluded from the warranty.
It must prove the date of purchase of the product with the corresponding invoice and with a photograph of the quality label number.